



**THANK YOU FOR BUYING A
HOTPOINT-ARISTON PRODUCT**

In order to receive a more complete assistance, please register your product on www.hotpoint.eu/register



Before using the appliance carefully read the Safety Instruction.

PRODUCT DESCRIPTION

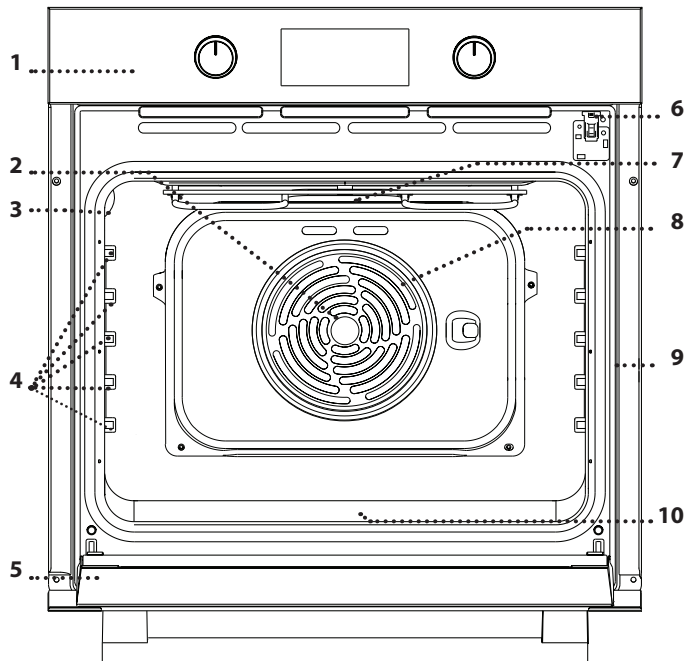

1. Control panel
2. Fan
3. Lamp
4. Shelf guides (the level is indicated on the wall of the cooking compartment)
5. Door
6. Door lock (locks the door while automatic cleaning is in progress and afterwards)
7. Upper heating element/grill
8. Circular heating element (not visible)
9. Identification plate (do not remove)
10. steam:  embossing for drinking water

CONTROL PANEL DESCRIPTION

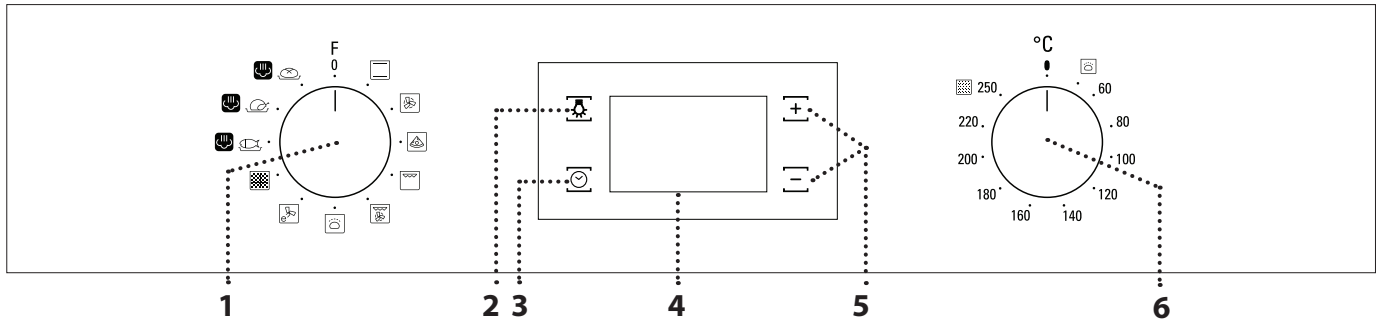

1. SELECTION KNOB

For switching the oven on by selecting a function. Turn to the 0 position to switch the oven off.

2. LIGHT

With the oven switched on, press  to turn the oven compartment lamp on or off.

3. SETTING THE TIME

For accessing the cooking time settings, delayed start and timer. For displaying the time when the oven is off.

4. DISPLAY

5. ADJUSTMENT BUTTONS

For changing the cooking time settings.

6. THERMOSTAT KNOB

Turn to select the temperature you require when activating manual functions.

ACCESSORIES

WIRE SHELF

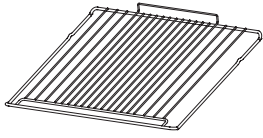

Use to cook food or as a support for pans, cake tins and other ovenproof items of cookware.

DRIP TRAY *

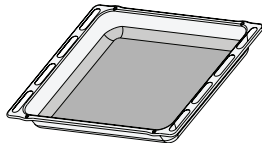

Use as an oven tray for cooking meat, fish, vegetables, focaccia, etc. or position underneath the wire shelf to collect cooking juices.

BAKING TRAY *

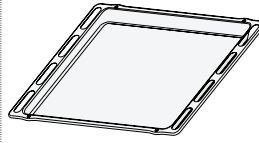

Use for cooking all bread and pastry products, but also for roasts, fish en papillote, etc.

SLIDING RUNNERS *

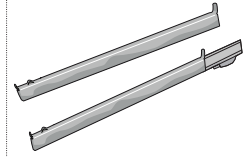

To facilitate inserting or removing accessories.

* Available only on certain models

The number and the type of accessories may vary depending on which model is purchased.

Other accessories can be purchased separately from the After-sales Service.

INSERTING THE WIRE SHELF AND OTHER ACCESSORIES

. Insert the wire shelf onto the level you require by holding it tilted slightly upwards and resting the raised rear side (pointing upwards) down first. Then slide it horizontally along the runners as far as possible.

. Other accessories, like the baking tray, are to be inserted horizontally, letting them slide on the runners.

REMOVING AND REFITTING THE SHELF GUIDES

. To remove the shelf guides, firmly grip the external part of the guide, and pull it towards you to extract the support and the two internal pins from the lodging.

. To reposition the shelf guides, position them near the cavity and initially insert the two pins into their lodgings. Next, position the external part near its lodging, insert the support, and firmly press towards the wall of the cavity to make sure the shelf guide is properly secured.

FITTING THE SLIDING RUNNERS (IF PRESENT)

Remove the shelf guides. Disengage the guide's anchoring clips from the shelf guide, starting from the lower part.

To reinstall the sliding guides, anchor the guide's upper clip to the shelf guide, then lower the other clip into position. To secure the guide, press the lower portion of the clip firmly against the shelf guide. Make sure that the runners can move freely. Reposition the shelf guides.

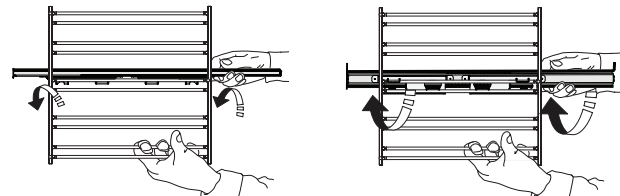



Please note: The sliding runners can be fitted on any level.

FUNCTIONS

 **CONVENTIONAL**
For cooking any kind of dish on one shelf only.

 **FORCED AIR**
For cooking different foods that require the same cooking temperature on several shelves (maximum three) at the same time. This function can be used to cook different foods without odours being transferred from one food to another.



 **PIZZA**
For baking different types and sizes of pizza and bread. It is a good idea to swap the position of the baking trays halfway through cooking.

 **GRILL**
For grilling steaks, kebabs and sausages, cooking vegetables au gratin or toasting bread.

When grilling meat, we recommend using a dripping pan to collect the cooking juices: position the pan on any of the levels below the wire shelf and add 200 ml of drinking water.



 **TURBO GRILL**
For roasting large joints of meat (legs, roast beef, chicken). We recommend using a dripping pan to collect the cooking juices: position the pan on any of the levels below the wire shelf and add 200 ml of drinking water.

 **RISING**
For helping sweet or savoury dough to rise effectively. Turn the *thermostat knob* to the icon to activate this function.

 **ECO FORCED AIR**
For cooking roasts and stuffed roasting joints on a single shelf. Food is prevented from drying out excessively by gentle, intermittent air circulation. When this ECO function is in use, the light will remain switched off during cooking but can be switched on again by pressing .

 **AUTOMATIC CLEANING - PYRO**
For eliminating cooking spatters using a cycle at very high temperature (over 400 °C).



steam 

- **FISH** 
- **MEAT** 
- **BREAD** 







The steam  functions provide excellent results thanks to the addition of steam in cooking cycles. Only when the oven is cold, pour drinking water on the bottom of the oven and select the specific function for your preparation. The optimal water quantities and temperatures for each food category are listed in the relative cooking table. **Do not preheat the oven before inserting food.**

FIRST TIME USE

1. SETTING THE TIME

You will need to set the time when you switch on the appliance for the first time: Press  until the  icon and the two digits for the hour start flashing on the display.





Use  or  to set the hour and press  to confirm. The two digits for the minutes will start flashing. Use  or  to set the minutes and press  to confirm.

Please note: When the  icon is flashing, for example following lengthy power outages, you will need to reset the time.



2. SET THE POWER CONSUMPTION

The oven is programmed to work at a power of less than 2.9 kW ("Lo"): To operate the oven at a power that is compatible with a domestic power supply of greater than 3 kW ("Hi"), you will need to change the settings.

To go to the change menu, turn the *selection knob* to , then turn it back to 0.

Press and hold  and  for five seconds immediately afterwards.



Use  or  to change the setting, then press and hold  for at least two seconds to confirm.

3. HEAT THE OVEN

A new oven may release odours that have been left behind during manufacturing: this is completely normal.

Before starting to cook food, we therefore recommend heating the oven with it empty in order to remove any possible odours.

Remove any protective cardboard or transparent film from the oven and remove any accessories from inside it.

Heat the oven to 250 °C for about one hour. The oven must be empty during this time.

Please note: It is advisable to air the room after using the appliance for the first time.

DAILY USE

1. SELECT A FUNCTION

To select a function, turn the *selection knob* to the symbol for the function you require: the display will light up and an audible signal will sound.



2. ACTIVATE A FUNCTION

MANUAL

To start the function you have selected, turn the *thermostat knob* to set the temperature you require.



Please note: During cooking you can change the function by turning the *selection knob* or adjust the temperature by turning the *thermostat knob*. The function will not start if the *thermostat knob* will be on 0. You can set the cooking time, cooking end time (only if you set a cooking time) and a timer.

RISING

To start the "Rising" function, turn the *thermostat knob* to the relevant symbol; if the oven is set to a different temperature, the function will not start.

Please note: You can set the cooking time, cooking end time (only if you set a cooking time) and a timer.

steam:

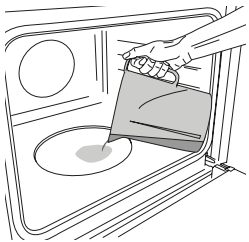

Only when the oven is cold, fill the embossing of the cavity with the quantity of drinking water suggested in the relative cooking table. Place the food in the oven.

Set and activate the steam: function: At the end, carefully open the door and let steam escape slowly.

Please note: During steam cooking, do not open the door and never top up the water.

3. PREHEATING

Once the function starts, an audible signal and a flashing icon on the display indicate that the preheating phase has been activated.

At the end of this phase, an audible signal and the fixed icon on the display will indicate that the oven has reached the set temperature: at this point, place the food inside and proceed with cooking.

Please note: Placing the food in the oven before preheating has finished may have an adverse effect on the final cooking result.

. PROGRAMMING COOKING

You will need to select a function before you can start programming cooking.

DURATION

Keep pressing until the icon and "00:00" start flashing on the display.



Use or to set the cooking time you require, then press to confirm.

Activate the function by turning the *thermostat knob* to the temperature you require: an audible signal will sound and the display will indicate that cooking is complete.

Please note: To cancel the cooking time you have set, keep pressing until the icon starts flashing on the display, then use to reset the cooking time to "00:00". This cooking time includes a preheating phase.

PROGRAMMING THE END COOKING TIME/ DELAYED START

After a cooking time has been set, starting the function can be delayed by programming its end time: press until the icon and the current time start flashing on the display.



Use or to set the time you want cooking to end and press to confirm.

Activate the function by turning the *thermostat knob* to the temperature you require: the function will remain paused until it starts automatically after the period of time that has been calculated in order for cooking to finish at the time you have set.

Please note: To cancel the setting, switch the oven off by turning the *selection knob* to the 0 position.

Delay to start functionality is not available for Grill and Turbo Grill functions.

END OF COOKING

An audible signal will sound and the display will indicate that the function has finished.





Turn the *selection knob* to select a different function or to 0 to switch the oven off.



Please note: If the timer is active, the display will show "END" alternately with the remaining time.



. SETTING THE TIMER

This option does not interrupt or program cooking but allows you to use the display as a timer, either during while a function is active or when the oven is off.

Keep pressing  until the  and "00:00" icon and "00:00" start flashing on the display.



Use  or  to set the time you require and press  to confirm. An audible signal will sound once the timer has finished counting down the selected time.

Notes: To cancel the timer, keep pressing  until the  icon starts flashing, then use  to reset the time to "00:00".

. AUTOMATIC CLEANING FUNCTION – PYRO

Do not touch the oven during the Pyro cycle. Keep children and animals away from the oven during and after (until the room has finished airing) running the Pyro cycle.

Remove all accessories - including shelf guides - from the oven before activating the function. If the oven is installed below a hob, make sure that all the burners or electric hotplates are switched off while running the selfcleaning cycle.

For optimum cleaning results, remove the worst soiling with a damp sponge before using the Pyro function.

Avoid activating the pyro cycle cleaning in the presence of limescale residues.















































































We recommend only running the Pyro function if the appliance contains heavy soiling or gives off bad odours during cooking.

To activate the automatic cleaning function, turn the *selection knob* and the *thermostat knob* to the  icon. The function will be activated automatically, the door locked and the light inside the oven switched off: The display will show the time remaining to the end, alternating with "Pyro".



Once the cycle has been completed, the door remains locked until the temperature inside the oven has returned to a safe level. Air the room during and after running the Pyro cycle.

COOKING TABLE

RECIPE	FUNCTION	PREHEAT	TEMPERATURE (°C)	DURATION (Min)	LEVEL AND ACCESSORIES
Leavened cakes		Yes	170	30 - 50	3 
		Yes	160	30 - 50	2 
		Yes	160	40 - 60	4 1  
Filled cake (cheese cake, strudel, fruit pie)		Yes	160 - 200	35 - 90	2 
		Yes	160 - 200	40 - 90	4 2  
Biscuits / tartlets		Yes	160	25 - 35	3 
		Yes	160	25 - 35	3 
		Yes	150	35 - 45	4 2  
Choux buns		Yes	180 - 210	30 - 40	3 
		Yes	180 - 200	35 - 45	4 2  
		Yes	180 - 200	35 - 45	5 3 1   
Meringues		Yes	90	150 - 200	3 
		Yes	90	140 - 200	4 2  
		Yes	90	140 - 200	5 3 1   
Pizza / Focaccia		Yes	190 - 250	15 - 50	1 / 2 
		Yes	190 - 250	20 - 50	4 2  
Frozen pizza		Yes	250	10 - 20	3 
		Yes	230-250	10 - 25	4 2  
Salty cakes (vegetable pie, quiche)		Yes	180 - 200	40 - 55	3 
		Yes	180 - 200	45 - 60	4 2  
		Yes	180 - 200	45 - 60	5 3 1   
Vols-au-vents / puff pastry crackers		Yes	190 - 200	20 - 30	3 
		Yes	180 - 190	20 - 40	4 2  
		Yes	180 - 190	20 - 40	5 3 1   
Lasagne / baked pasta / cannelloni / flans		Yes	190 - 200	45 - 65	2 
Lamb / veal / beef / pork 1 kg		Yes	190 - 200	80 - 110	3 
Roast pork with crackling 2 kg		Yes	180 - 190	110 - 150	3 
Chicken / rabbit / duck 1 kg		Yes	200 - 230	50 - 100	2 
Turkey / goose 3 kg		-	190 - 200	100 - 160	2 
Baked fish / en papillote (fillets, whole)		Yes	170 - 190	30 - 45	2 
Stuffed vegetables (tomatoes, courgettes, aubergines)		Yes	180 - 200	50 - 70	3 

FUNCTIONS



Conventional



Forced Air



Pizza



Grill



Turbo Grill



Eco Forced Air

ACCESSORIES



Wire shelf



Baking dish or cake tin
on the wire shelf



Baking tray/Drip tray or
Baking dish on the wire shelf



Drip tray / Baking tray



Drip tray / Baking tray with
200 ml of water

RECIPE	FUNCTION	PREHEAT	TEMPERATURE (°C)	DURATION (Min)	LEVEL AND ACCESSORIES
Toasted bread		5'	250	2 - 6	5
Fish fillets / slices		-	230 - 250	15 - 30 *	4 3
Sausages / kebabs / spare ribs / hamburgers		-	250	15 - 30 *	5 4
Roast chicken 1-1.3 kg		Yes	200 - 220	55 - 70 **	2 1
Roast beef rare 1 kg		Yes	200 - 210	35 - 50 **	3
Leg of lamb / knuckle		Yes	200 - 210	60 - 90 **	3
Roast potatoes		Yes	200 - 210	35 - 55	2
Vegetable gratin		-	200 - 210	25 - 55	3
Meat and potatoes		Yes	190 - 200	45 - 100 ***	4 1
Fish and vegetables		Yes	180	30 - 50 ***	4 2
Lasagne and meat		Yes	200	50 - 100 ***	4 1
Complete meal: fruit tart (level 5) / lasagne (level 3) / meat (level 1)		Yes	180 - 190	40 - 120 ***	5 3 1
Roast meat / stuffed roasting joints		-	170 - 180	100 - 150	3

* Turn food halfway through cooking

** Turn food two thirds of the way through cooking (if necessary).

*** Estimated length of time: dishes can be removed from the oven at different times depending on personal preference.

steam

RECIPE	FUNCTION	WATER (ml)	PREHEAT	TEMPERATURE (°C)	DURATION (Min)	LEVEL AND ACCESSORIES
Fish fillets / cutlets 0.5 - 2 cm	steam	250	-	190 - 210	15 - 25	3
Whole fish 300 - 600 g	steam	250	-	190 - 210	15 - 30	3
Whole fish 600 g - 1.2 kg	steam	250	-	180 - 200	25 - 45	3
Roast Beef rare 1 kg	steam	250	-	190 - 210	40 - 55	3
Lamb shank 500 g - 1.5 kg	steam	250	-	170 - 190	60 - 75	2
Chicken / guinea fowl / duck Whole 1 - 1.5 kg	steam	250	-	200 - 220	55 - 75	2
Chicken / guinea fowl / duck Pieces 500 g - 1.5 kg	steam	250	-	200 - 220	40 - 60	3
Chicken / turkey / duck Whole 3 kg	steam	250	-	160 - 180	100 - 140	2
Lamb / Beef / Pork 1 kg	steam	250	-	170 - 190	60 - 100	3
Small bread 80 - 100 g	steam	200	-	200 - 220	30 - 45	3
Sandwich loaf in tin 300 - 500 g	steam	250	-	170 - 190	45 - 60	3
Bread loaf 500 g - 2 kg	steam	250	-	160 - 170	50 - 100	2
Baguettes 200 - 300 g	steam	250	-	200 - 220	30 - 45	3

The time indicated includes the preheating phase: we recommend placing the food in the oven and setting the cooking time when starting the function.

FUNCTIONS							steam	steam	steam
	Conventional	Forced Air	Pizza	Grill	Turbo Grill	Eco Forced Air	Fish	Meat	Bread
ACCESSORIES									
	Wire shelf	Baking dish or cake tin on the wire shelf	Baking tray/Drip tray or Baking dish on the wire shelf	Drip tray / Baking tray	Drip tray / Baking tray	Drip tray / Baking tray	Drip tray / Baking tray with 200 ml of water		

Hotpoint

ARISTON

CLEANING AND MAINTENANCE

Make sure that the oven has cooled down before carrying out any maintenance or cleaning. Do not use steam cleaners.

Do not use wire wool, abrasive scourers or abrasive/corrosive cleaning agents, as these could damage the surfaces of the appliance.

Wear protective gloves. The oven must be disconnected from the mains before carrying out any kind of maintenance work.

EXTERIOR SURFACES

Clean the surfaces with a damp microfibre cloth. If they are very dirty, add a few drops of pH-neutral detergent. Finish off with a dry cloth.

Do not use corrosive or abrasive detergents. If any of these products inadvertently comes into contact with the surfaces of the appliance, clean immediately with a damp microfibre cloth.

INTERIOR SURFACES

• After every use, leave the oven to cool and then clean it, preferably while it is still warm, to remove any deposits or stains caused by food residues. To dry any condensation that has formed as a result of cooking foods with a high water content, leave the oven to cool completely and then wipe it with a cloth or sponge.

• To remove the remaining limescale from the bottom of the cavity after the steam cooking, just pour 250 ml of white vinegar onto the embossing of the cavity (alternatively, use a specific descaling product. For

availability please contact the After Sales Service). Leave it to work at room temperature for 30 minutes, then clean the cavity with warm drinking water and a soft cloth. Cleaning is recommended at least for every 5 to 10 steam cooking cycles.

• If there is stubborn dirt on the interior surfaces, we recommend running the automatic cleaning function for optimal cleaning results. Avoid activating the pyrolytic cycle cleaning in the presence of limescale residues. Before activating, perform limescale cleaning as described above.

• The door can be easily removed and refitted to facilitate cleaning of the glass.

• Clean the glass in the door with a suitable liquid detergent.

ACCESSORIES

Soak the accessories in a washing-up liquid solution after use, handling them with oven gloves if they are still hot. Food residues can be removed using a washing-up brush or a sponge.

REMOVING AND REFITTING THE DOOR

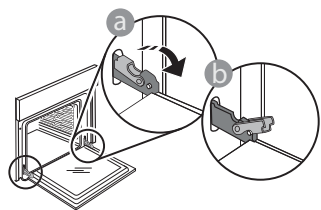

• To remove the door, open it fully and lower the catches until they are in the unlock position.

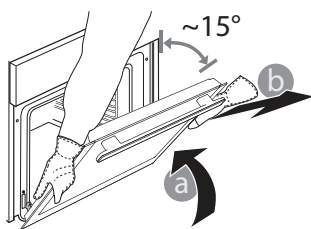

2. Close the door as much as you can. Take a firm hold of the door with both hands – do not hold it by the handle. Simply remove the door by continuing to close it while pulling it upwards at the same time until it is

released from its seating. Put the door to one side, resting it on a soft surface.

3. Refit the door by moving it towards the oven, aligning the hooks of the hinges with their seating and securing the upper part onto its seating.

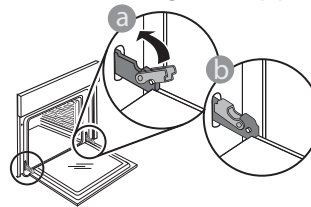

4. Lower the door and then open it fully. Lower the catches into their original position: Make sure that you lower them down completely.

Apply gentle pressure to check that the catches are in the correct position.

5. Try closing the door and check to make sure that it lines up with the control panel. If it does not, repeat the steps above: The door could become damaged if it does not work properly.

REPLACING THE LAMP

1. Disconnect the oven from the power supply.
2. Unscrew the cover from the light, replace the bulb and screw the cover back on the light.
3. Reconnect the oven to the power supply.

Please note: Use 25 W/230 V type G9, T300 °C halogen lamps. The bulb used in the product is specifically designed for domestic appliances and is not suitable for general room lighting within the home (EC Regulation 244/2009).

Light bulbs are available from our After-sales Service. - Do not handle bulbs with your bare hands as your fingerprints could damage them. Do not use the oven until the light cover has been refitted.

CLICK TO CLEAN - CLEANING THE GLASSES

1. After removing the door and resting it on a soft surface with the handle downwards, simultaneously press the two retaining clips and remove the upper edge of the door by pulling it towards you.

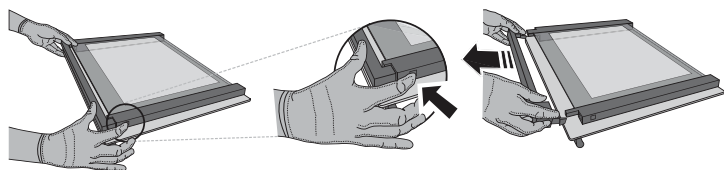

2. Lift and firmly hold the inner glass with both hands, remove it and place it on a soft surface before cleaning it.

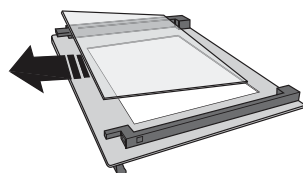

3. Refit the intermediate pane (marked with "1R") before refitting the inside pane: To position the panes of glass correctly, make sure that the "R" mark can be seen in the left-hand corner. First insert the long side of the glass marked "R" into the support seats, then lower it into position. Repeat this procedure for both panes of glass.

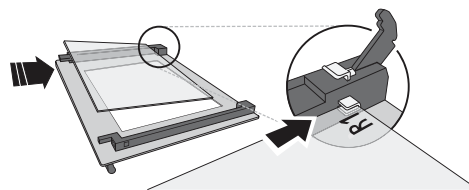

4. Refit the upper edge: A click will indicate correct positioning. Make sure the seal is secure before refitting the door.

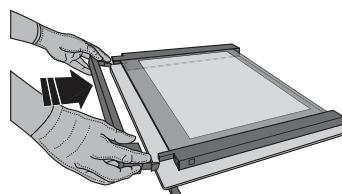

TROUBLESHOOTING

PROBLEM	POSSIBLE CAUSE	SOLUTION
The oven is not working.	Power cut. Disconnection from the mains.	Check for the presence of mains electrical power and whether the oven is connected to the electricity supply. Turn off the oven and restart it to see if the fault persists.
The display shows the letter "F" followed by a number or letter.	Oven failure.	Contact your nearest Client After-sales Service Centre and state the number following the letter "F".
The display is showing the message "Hot" and the selected function will not start.	Temperature too high.	Allow the oven to cool down before activating the function. Select a different function.



You can download the Safety Instructions, User Manual, Product Fiche and Energy data by:

- Visiting our website docs.hotpoint.eu
- Using QR Code
- Alternatively, **contact our After-sales Service** (See phone number in the warranty booklet). When contacting our After-sales Service, please state the codes provided on your product's identification plate.

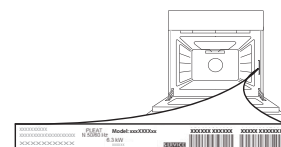



MERCI D'AVOIR ACHETÉ UN PRODUIT HOTPOINT-ARISTON

Afin de profiter d'une assistance complète, veuillez enregistrer votre appareil sur www.hotpoint.eu/register



Lisez attentivement les consignes de sécurité avant d'utiliser l'appareil.

DESCRIPTION DU PRODUIT

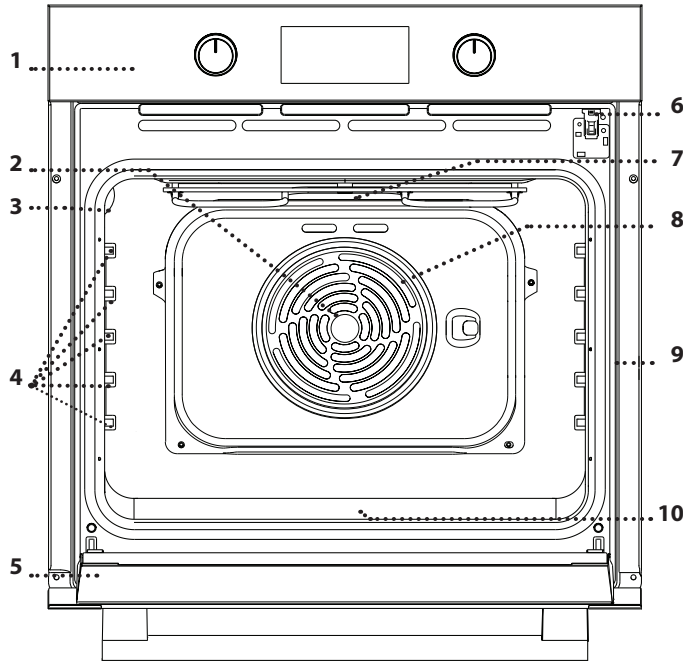

1. Bandeau de commande
2. Ventilateur
3. Ampoule
4. Supports de grille (le niveau est indiqué sur la paroi du compartiment de cuisson)
5. Porte
6. Verrou de la porte (verrouille la porte lorsque le nettoyage automatique est en cours et après)
7. Élément chauffant supérieur/grill
8. Élément chauffant rond (invisible)
9. Plaque signalétique (ne pas enlever)
10. steam gaufrage pour eau potable

DESCRIPTION DU BANDEAU DE COMMANDE

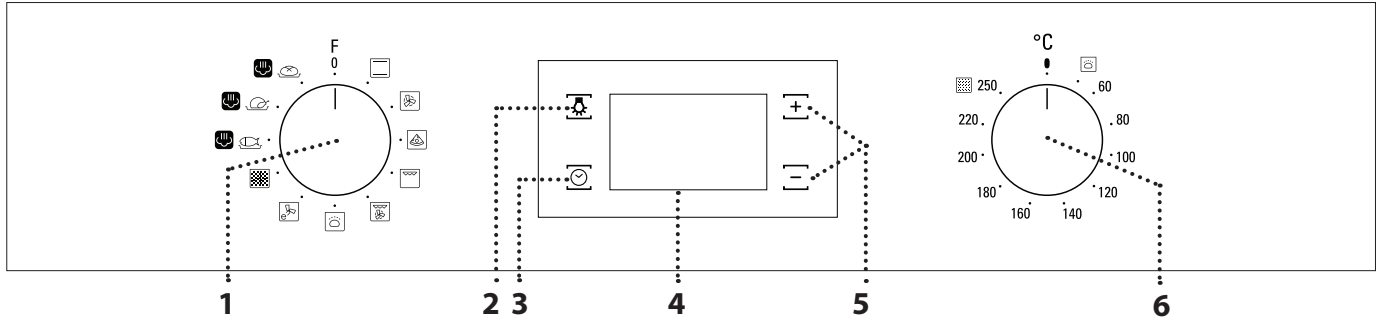

1. BOUTON DE SÉLECTION

Pour allumer le four en sélectionnant une fonction. Tournez dans la position 0 pour éteindre le four.

2. LAMPE

Avec le four allumé, appuyez sur pour allumer ou éteindre l'ampoule du compartiment du four.

3. RÉGLAGE DE L'HEURE

Pour accéder les réglages pour le temps de cuisson, le départ différé, et la minuterie.

Pour afficher l'heure lorsque le four est éteint.

4. ÉCRAN

5. BOUTONS DE RÉGLAGES

Pour changer les réglages du temps de cuisson.

6. BOUTON THERMOSTAT

Tournez pour sélectionner la température désirée lorsque vous utilisez les fonctions manuelles.

ACCESSOIRES

GRILLE MÉTALLIQUE

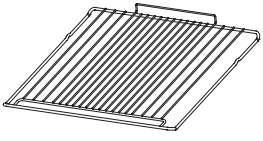

Utilisées pour la cuisson des aliments ou comme support pour les lèchefrites, moules à gâteau, et autres plats de cuisson résistants à la chaleur.

LÈCHEFRITE*

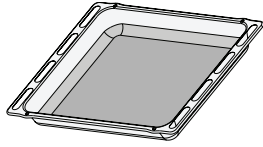

Utiliser comme plat de cuisson pour la viande, le poisson, les légumes, la focaccia, etc., ou pour recueillir les jus de cuisson en la plaçant sous la grille métallique.

PLAQUE À PÂTISSERIE *

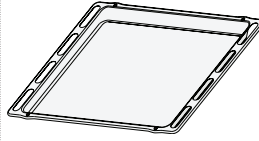

Pour la cuisson du pain et des pâtisseries, mais aussi pour cuire des rôtis, du poisson en papillotes, etc.

GRILLES COULISSANTES *

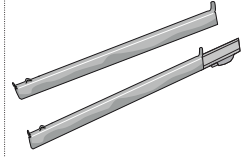

Pour insérer ou enlever les accessoires plus facilement.

* Disponible sur certains modèles seulement

Le nombre et type d'accessoires peuvent varier selon le modèle acheté.

Il est possible d'acheter séparément d'autres accessoires auprès du Service Après-Vente.

INSÉRER LA GRILLE MÉTALLIQUE ET LES AUTRES ACCESSOIRES

. Insérez la grille métallique au niveau désiré en la tenant légèrement inclinée vers le haut et en déposant la partie surélevée arrière (pointant vers le haut) en premier.

Glissez-la ensuite horizontalement sur les glissières aussi loin que possible.

. Les autres accessoires, comme la plaque de cuisson, sont insérés horizontalement en les laissant glisser sur les guides.

ENLEVER ET REPLACER LES SUPPORTS DE GRILLE

. Pour enlever les supports de grille, agrippez fermement la partie externe du support et tirez-le vers vous pour sortir le support et les deux goupilles internes de leur appui.

. Pour replacer les supports de grille, placez-les près de la cavité et insérez en premier les deux goupilles dans leur appui. Ensuite, placez la partie externe près de son appui, insérez le support, et appuyez fermement vers la paroi pour s'assurer que le support est bien inséré.

INSTALLER LES GRILLES COULISSANTES (SELON LE MODÈLE)

Enlevez les supports de grille. Dégagez les agrafes d'ancrages du support de grille, en commençant avec la partie inférieure.

Pour installer de nouveau les supports de grille, ancrer l'agrafe supérieure du support en place, abaissez ensuite l'autre agrafe en place. Pour fixer le guide, pressez la partie inférieure de l'agrafe fermement sur le support de grille. Assurez-vous que les grilles peuvent se déplacer librement. Remplacez les supports de grille.

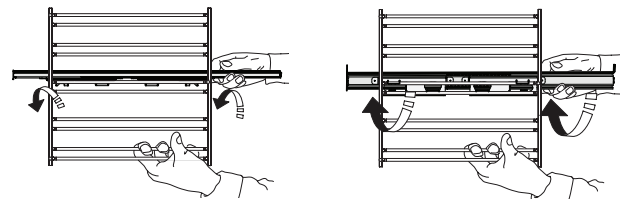

Veillez noter : Les grilles coulissantes peuvent être installées au niveau de votre choix.

Hotpoint

ARISTON

FONCTIONS

 **CONVECTION NATURELLE**
Pour cuire tout type de plat sur une seule grille.

 **AIR PULSÉ**
Pour cuire différents aliments demandant la même température de cuisson sur plusieurs grilles (maximum de trois) en même temps. Cette fonction permet de cuire différents aliments sans transmettre les odeurs d'un aliment à l'autre.



 **PIZZA**
Pour cuire différents types et tailles de pain et de pizza. Nous vous conseillons d'échanger la position des plaques de cuisson à la mi-cuisson.

 **GRIL**
Pour cuire des biftecks, des brochettes, et des saucisses, faire gratiner des légumes et griller du pain.

Pour la cuisson de la viande, nous vous conseillons d'utiliser une lèchefrite pour recueillir les jus de cuisson : placez la lèchefrite, contenant 200 ml d'eau, sur n'importe quel niveau sous la grille métallique.



 **TURBO GRIL**
Pour griller de gros morceaux de viande (gigots, rôti de bœuf, poulets). Nous vous conseillons d'utiliser une lèchefrite pour recueillir les jus de cuisson : placez la lèchefrite, contenant 200 ml d'eau, sur un quelconque niveau sous la grille.

 **LEVAGE**
Pour aider les pâtes sucrées ou salées à mieux lever. Tournez le *bouton de thermostat* vers l'icône pour activer cette fonction.

 **ÉCO AIR PULSÉ**
Pour cuire les rôtis farcis et les rôtis sur une seule grille. Les aliments ne s'assèchent pas trop grâce à une légère circulation d'air intermittente. Lorsque vous utilisez la fonction ÉCO, le voyant reste éteint durant la cuisson, mais peut être rallumé temporairement en appuyant sur .

 **NETTOYAGE AUTOMATIQUE - PYRO**
Pour éliminer les éclaboussures de la cuisson en utilisant un cycle à très haute température (plus de 400 °C).



steam 

- **POISSON** 
- **VIANDES** 
- **PAIN** 







Les fonctions steam  donnent d'excellents résultats grâce à l'ajout de vapeur dans les cycles de cuisson. Placez de l'eau potable au fond de la cavité et sélectionnez la fonction spécifique pour votre préparation, uniquement lorsque le four est froid. Les quantités et températures optimales de l'eau pour chaque catégorie d'aliments sont énumérées dans le tableau de cuisson correspondant. **Ne préchauffez pas le four avant d'insérer les aliments.**

PREMIÈRE UTILISATION

1. RÉGLAGE DE L'HEURE

Vous devez régler l'heure lorsque vous allumez l'appareil pour la première fois : Appuyez sur  jusqu'à ce que le voyant  et les deux chiffres indiquant l'heure clignotent à l'écran.



Utilisez  ou  pour régler l'heure et appuyez sur  pour confirmer. Les deux chiffres des minutes clignotent. Utilisez  ou  pour régler les minutes et appuyez sur  pour confirmer.

Veillez noter : Lorsque le voyant  clignote (par exemple après des pannes de courant prolongées), vous devrez régler l'heure de nouveau.



2. RÉGLER LA CONSOMMATION ÉNERGÉTIQUE

Le four est programmé pour fonctionner avec une puissance inférieure à 2,9 kW (« Lo ») : Pour utiliser le four avec une puissance compatible avec un réseau électrique domestique supérieur à 3 kW (« Hi »), vous devez changer les réglages.

Pour accéder au menu de réglage, tournez le *bouton de sélection* sur , puis retournez-le ensuite sur 0.

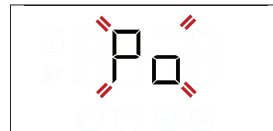
Appuyez sur  et  pour cinq secondes immédiatement après.



Utilisez  ou  pour changer les réglages, appuyez ensuite sur  pour au moins deux secondes pour confirmer.

3. CHAUFFER LE FOUR

Un nouveau four peut dégager des odeurs provenant de la fabrication : ceci est parfaitement normale.

Avant de cuire des aliments, nous vous conseillons de chauffer le four à vide pour éliminer les odeurs.

Enlever les cartons de protection ou les pellicules transparentes du four, et enlever les accessoires qui se trouvent à l'intérieur.

Chauffez le four à 250 °C pendant environ une heure. Le four doit être vide durant cette opération.

Veillez noter : Nous vous conseillons d'aérer la pièce après avoir utilisé l'appareil pour la première fois.

UTILISATION QUOTIDIENNE

1. SÉLECTIONNER UNE FONCTION

Pour sélectionner une fonction, tournez le *bouton de sélection* sur le symbole de la fonction désirée : l'écran s'illumine et un signal sonore se fait entendre.



2. ACTIVER UNE FONCTION

MANUEL

Pour lancer la fonction que vous avez sélectionnée, tournez le *bouton du thermostat* pour régler la température requise.



Veillez noter : Lors de la cuisson, vous pouvez changer la fonction en tournant le *bouton de sélection* ou ajuster la température en tournant le *bouton du thermostat*. La fonction ne démarre pas tant que le *bouton du thermostat* est sur 0. Vous pouvez régler le temps de cuisson, le temps de fin de cuisson (seulement si vous réglez le temps de cuisson) et la minuterie.

LEVAGE

Pour lancer la fonction « Levage de la pâte », tournez le *bouton thermostat* au symbole correspondant; si le four est réglé à une température différente, la fonction de démarrage pas.

Veillez noter : Vous pouvez régler le temps de cuisson, le temps de fin de cuisson (seulement si vous réglez le temps de cuisson) et la minuterie.



Une fois que le four est froid seulement, remplissez le gaufre de la cavité avec la quantité d'eau potable suggérée dans le tableau de cuisson correspondant. Enfourez le plat.

Réglez et activez la fonction steam:☁ : À la fin, ouvrez la porte avec précaution et laissez la vapeur s'échapper lentement.

Veillez noter : Pendant la cuisson à la vapeur, n'ouvrez pas le four et ne rajoutez jamais d'eau.

3. PRÉCHAUFFAGE

Une fois que la fonction est lancée, un signal sonore et un voyant qui clignote à l'écran confirmant que la phase de préchauffage est activée.

À la fin de cette phase, un signal sonore et un voyant stable indique que le four a atteint la température désirée : vous pouvez maintenant placer les aliments à l'intérieur et débiter la cuisson.

Veillez noter : Placer les aliments dans le four avant que le préchauffage soit terminé peut affecter la cuisson finale.

. PROGRAMMER LA CUISSON

Vous devez sélectionner une fonction avant de pouvoir lancer un programme de cuisson.

DURÉE

Appuyez sur la touche jusqu'à ce que le voyant et « 00:00 » clignotent à l'écran.



Utilisez ou pour régler le temps de cuisson dont vous avez besoin, puis appuyez sur pour confirmer.

Lancez la fonction en tournant le *bouton du thermostat* à la température désirée : un signal sonore se fait entendre et l'écran s'illumine lorsque la cuisson est terminée.

Veillez noter : Pour annuler le temps de cuisson, appuyez sur jusqu'à ce que le voyant clignote sur l'écran, utilisez ensuite pour remettre le temps de cuisson à « 00:00 ». Ce temps de cuisson inclut la phase de préchauffage.

PROGRAMMER L'HEURE DE FIN DE CUISSON/ DÉPART DIFFÉRÉ

Après avoir réglé le temps de cuisson, vous pouvez retarder le début de la fonction en programmant le temps de fin de cuisson : appuyez sur jusqu'à ce que l'icône et l'heure actuelle clignotent à l'écran.

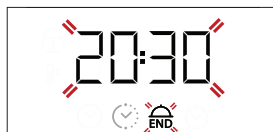

Utilisez ou pour régler l'heure de fin de cuisson et appuyez sur pour confirmer.

Lancez la fonction en tournant le *bouton du thermostat* à la température désirée : la fonction reste en veille et démarre automatiquement après la période d'attente calculée pour que la cuisson se termine à l'heure désirée.

Veillez noter : Pour annuler le réglage, éteindre le four en tournant le *bouton de sélection* à la position « 0 ».

Le démarrage différé de la fonctionnalité n'est pas disponible pour les fonctions Grill et Turbo-grill.

FIN DE CUISSON

Un signal sonore se fait entendre et l'écran s'illumine pour indiquer que la fonction est terminée.

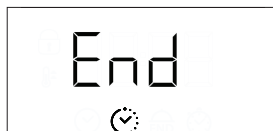

Tournez le *bouton de sélection* pour sélectionner une différente fonction ou placez-le dans la position 0 pour éteindre le four.



Veillez noter : Si la minuterie fonctionne, l'écran affiche « END » en alternance avec le temps restant.

Hotpoint



ARISTON



. RÉGLER LA MINUTERIE

Cette option n'interrompt pas ou ne programme pas la cuisson, mais permet d'utiliser l'écran comme minuterie, durant le fonctionnement d'une fonction ou quand le four est éteint.

Maintenez la touche  appuyée jusqu'à ce que l'icône  et "00:00" et "00:00" commence à clignoter sur l'écran.



Utilisez  ou  pour régler l'heure désirée et appuyez sur  pour confirmer. Un signal sonore se fait entendre lorsque la minuterie a terminé le compte à rebours.

Remarques : Pour annuler la minuterie, appuyez sur  jusqu'à ce que le voyant  clignote, utilisez ensuite  pour remettre le temps à « 00:00 ».

. FONCTION DE NETTOYAGE AUTOMATIQUE - PYRO

Ne touchez pas le four pendant le cycle Pyro. Éloignez les enfants et les animaux du four pendant et après (le temps que la pièce soit bien aérée) le cycle de nettoyage Pyro.

Retirez tous les accessoires du four - incluant les supports de grille - avant d'activer la fonction. Si le four est installé sous une table de cuisson, assurez-vous que les brûleurs ou les plaques électriques sont éteints pendant le cycle d'auto-nettoyage.

Pour de meilleurs résultats, éliminez les résidus les plus tenaces à l'aide d'une éponge humide avant d'utiliser la fonction Nettoyage Pyro.

Évitez d'activer le cycle de pyrolyse en présence de résidus de calcaire.

Nous vous conseillons d'utiliser la fonction Nettoyage Pyro seulement si le four est très sale ou s'il dégage de mauvaises odeurs lors de la cuisson.

Pour lancer la fonction de nettoyage automatique, tournez le *bouton de sélection* et le *bouton du thermostat* sur l'icône . La fonction démarre automatiquement, la porte se verrouille, et l'ampoule à l'intérieur du four s'éteint : L'écran affiche le temps restant avant la fin, en alternance avec « Pyro ».



Une fois le cycle terminé, la porte reste verrouillée jusqu'à ce que la température à l'intérieur du four atteigne un niveau sécuritaire. Aérez la pièce pendant et après avoir utilisé le cycle Pyro.

TABLEAU DE CUISSON

RECETTE	FONCTION	PRÉCHAUFFAGE	TEMPÉRATURE (°C)	DURÉE (Min)	NIVEAU ET ACCESSOIRES
Gâteaux à pâte levée		Oui	170	30 - 50	3
		Oui	160	30 - 50	2
		Oui	160	40 - 60	4 1
Gâteau fourré (gâteau au fromage, strudel, tarte aux fruits)		Oui	160 - 200	35 - 90	2
		Oui	160 - 200	40 - 90	4 2
Biscuits/Tartelettes		Oui	160	25 - 35	3
		Oui	160	25 - 35	3
		Oui	150	35 - 45	4 2
Chouquettes		Oui	180 - 210	30 - 40	3
		Oui	180 - 200	35 - 45	4 2
		Oui	180 - 200	35 - 45	5 3 1
Meringues		Oui	90	150 - 200	3
		Oui	90	140 - 200	4 2
		Oui	90	140 - 200	5 3 1
Pizza/Focaccia		Oui	190 - 250	15 - 50	1 / 2
		Oui	190 - 250	20 - 50	4 2
Pizza surgelée		Oui	250	10 - 20	3
		Oui	230-250	10 - 25	4 2
Tartes salées (tarte aux légumes, quiche)		Oui	180 - 200	40 - 55	3
		Oui	180 - 200	45 - 60	4 2
		Oui	180 - 200	45 - 60	5 3 1
Vol-au-vent/biscuits à pâte feuilletée		Oui	190 - 200	20 - 30	3
		Oui	180 - 190	20 - 40	4 2
		Oui	180 - 190	20 - 40	5 3 1
Lasagnes / pâtes au four / cannellonis / tartes		Oui	190 - 200	45 - 65	2
Agneau / Veau / Bœuf / Porc 1 kg		Oui	190 - 200	80 - 110	3
Rôti de porc avec grattons 2 kg		Oui	180 - 190	110 - 150	3
Poulet/lapin/canard 1 kg		Oui	200 - 230	50 - 100	2
Dinde / Oie 3 kg		-	190 - 200	100 - 160	2
Poisson au four / en papillote (filet, entier)		Oui	170 - 190	30 - 45	2
Légumes farcis (tomates, courgettes, aubergines)		Oui	180 - 200	50 - 70	3

FONCTIONS

Convection naturelle

Air pulsé

Pizzas

Gril

Turbo Gril

Éco Air pulsé

ACCESSOIRES

Grille métallique

Plaque de cuisson ou moule à gâteau sur la grille métallique

Lèche-frite / Plaque de cuisson

Lèche-frite / Plaque de cuisson avec 200 ml d'eau

Hotpoint

ARISTON

RECETTE	FONCTION	PRÉCHAUFFAGE	TEMPÉRATURE (°C)	DURÉE (Min)	NIVEAU ET ACCESSOIRES
Pain grillé		5'	250	2 - 6	5
Filets/tranches de poisson		-	230 - 250	15 - 30 *	4 3
Saucisses/brochettes/ côtes levées/hamburgers		-	250	15 - 30 *	5 4
Poulet rôti 1-1,3 kg		Oui	200 - 220	55 - 70 **	2 1
Rôti de bœuf saignant 1 kg		Oui	200 - 210	35 - 50 **	3
Gigot d'agneau/jarret		Oui	200 - 210	60 - 90 **	3
Pommes de terre rôties		Oui	200 - 210	35 - 55	2
Gratin de légumes		-	200 - 210	25 - 55	3
Viandes et pommes de terre		Oui	190 - 200	45 - 100 ***	4 1
Poisson et légumes		Oui	180	30 - 50 ***	4 2
Lasagnes & viande		Oui	200	50 - 100 ***	4 1
Repas complet : tarte aux fruits (niveau 5)/ lasagne (niveau 3)/ viande (niveau 1)		Oui	180 - 190	40 - 120 ***	5 3 1
Rôtis/rôtis farcis		-	170 - 180	100 - 150	3

*Tourner les aliments à mi-cuisson

** Au besoin, retournez les aliments aux deux tiers de la cuisson.

*** Temps approximatif : les plats peuvent être retirés du four en tout temps, selon vos préférences personnelles.

steam

RECETTE	FONCTION	EAU (ml)	PRÉCHAUFFAGE	TEMPÉRATURE (°C)	DURÉE (Min)	NIVEAU ET ACCESSOIRES
Filets de poisson / côtelettes 0,5 - 2 cm	steam	250	-	190 - 210	15 - 25	3
Poisson entier 300 - 600 g	steam	250	-	190 - 210	15 - 30	3
Poisson entier 600 g - 1,2 kg	steam	250	-	180 - 200	25 - 45	3
Rosbif saignant 1 kg	steam	250	-	190 - 210	40 - 55	3
Jarret d'agneau 500 g - 1,5 kg	steam	250	-	170 - 190	60 - 75	2
Poulet / pintade / canard Entier 1 - 1,5 kg	steam	250	-	200 - 220	55 - 75	2
Poulet / pintade / canard Morceaux de 500 g - 1,5 kg	steam	250	-	200 - 220	40 - 60	3
Poulet / dinde / canard Entier 3 kg	steam	250	-	160 - 180	100 - 140	2
Agneau / Bœuf / Porc 1 kg	steam	250	-	170 - 190	60 - 100	3
Petit pain 80 - 100 g	steam	200	-	200 - 220	30 - 45	3
Pain à sandwich en moule 300 - 500 g	steam	250	-	170 - 190	45 - 60	3
Pain 500 g - 2 kg	steam	250	-	160 - 170	50 - 100	2
Baguettes 200 - 300 g	steam	250	-	200 - 220	30 - 45	3

Le temps indiqué comprend la phase de préchauffage : nous recommandons de placer les aliments dans le four et de régler la durée de cuisson lors du démarrage de la fonction.

FONCTIONS							steam	steam	steam
	Convection naturelle	Air pulsé	Pizzas	Grill	Turbo Grill	Éco Air pulsé	Poisson	Viandes	Pain
ACCESSOIRES									
	Grille métallique	Plaque de cuisson à gâteau	Plaque de cuisson ou moule à gâteau sur la grille métallique	Plaque de cuisson/lèche-frite ou plat de cuisson sur grille métallique	Lèche-frite / Plaque de cuisson	Lèche-frite / Plaque de cuisson	Lèche-frite / Plaque de cuisson avec 200 ml d'eau		

Hotpoint

ARISTON

NETTOYAGE ET ENTRETIEN

Assurez-vous que le four ait refroidi avant tout entretien ou nettoyage.

N'utilisez pas de nettoyeur à vapeur.

N'utilisez pas de laine d'acier, de tampons à récurer abrasifs, ou des détergents abrasifs ou corrosifs, ils pourraient endommager les surfaces de l'appareil.

Utilisez des gants de protection. L'appareil doit être débranché de l'alimentation principale avant d'effectuer des travaux d'entretien.

SURFACES EXTÉRIEURES

Nettoyez les surfaces à l'aide d'un chiffon en microfibre humide. Si elles sont très sales, ajoutez quelques gouttes de détergent à pH neutre. Essayez avec un chiffon sec.

N'utilisez pas de détergents corrosifs ou abrasifs. Si l'un de ces produits entre en contact avec des surfaces de l'appareil, nettoyez immédiatement à l'aide d'un chiffon en microfibre humide.

SURFACES INTÉRIEURES

• Après chaque utilisation, laissez le four refroidir et nettoyez-le, de préférence lorsqu'il est encore tiède, pour enlever les dépôts ou taches laissés par les résidus de nourriture. Pour enlever la condensation qui se serait formée lors de la cuisson d'aliments avec une forte teneur en eau, laissez le four refroidir complètement et essuyez-le avec un chiffon ou une éponge.

• Pour enlever le calcaire résiduel du fond de la cavité après la steam-cuisson, il suffit de verser 250 ml de vinaigre blanc sur le gaufrage de la cavité (en variante, utilisez un produit de détartrage spécifique. Pour connaître la disponibilité,

contactez le Service après-vente).

Laissez-le fonctionner à la température ambiante pendant 30 minutes, puis nettoyez la cavité avec de l'eau potable tiède et un chiffon doux. Le nettoyage est recommandé au moins tous les 5 à 10 steam-cycles de cuisson.

• S'il y a des tâches tenaces sur les surfaces intérieures, nous vous conseillons d'utiliser la fonction de nettoyage automatique pour de meilleurs résultats. Évitez d'activer le cycle de pyrolyse en présence de résidus de calcaire. Avant l'activation, effectuez un nettoyage du calcaire comme décrit ci-dessus.

• La porte peut facilement être enlevée et remplacée pour faciliter le nettoyage de la vitre.

• Nettoyez le verre dans la porte avec un détergent liquide approprié.

ACCESSOIRES

Faire tremper les accessoires dans de l'eau contenant un détergent à vaisselle après les avoir utilisés ; utilisez des gants de cuisine s'ils sont encore chauds. Utilisez une brosse à vaisselle ou une éponge pour enlever les résidus d'aliments.

ENLEVER ET RÉINSTALLER LA PORTE

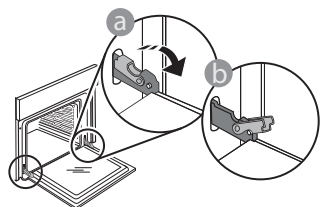

1. Pour enlever la porte, ouvrez-la complètement et abaissez les loquets jusqu'à qu'ils soient déverrouillés.

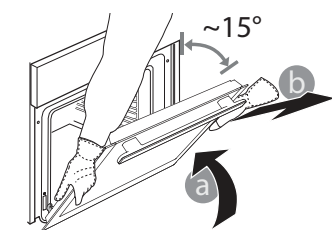

2. Fermez le plus possible la porte. Tenez la porte fermement avec les deux mains – ne la tenez pas par la poignée. Enlevez simplement la porte en continuant à la fermer tout en la tirant vers le haut jusqu'à ce qu'elle soit dégagée de ses

appuis. Placez la porte de côté, l'appuyant sur une surface souple.

3. Réinstallez la porte en la plaçant devant le four pour aligner les crochets des charnières avec leurs appuis et attacher la partie supérieure sur son appui.

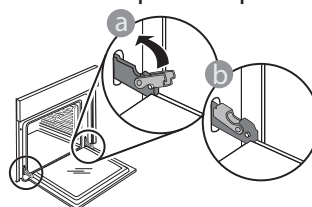

4. Abaissez la porte pour ensuite l'ouvrir complètement. Abaissez les loquets dans leur position originale : Assurez-vous de les abaisser complètement.

Appliquez une légère pression pour vous assurer que les loquets sont bien placés.

5. Essayez de fermer la porte et assurez-vous qu'elle est alignée avec le panneau de commande. Sinon, répétez les étapes précédentes : La porte pourrait s'endommager si elle ne fonctionne pas correctement.

REPLACEMENT DE L'AMPOULE

1. Débranchez le four de l'alimentation électrique.
2. Dévissez le couvercle de l'ampoule, remplacez l'ampoule, et revissez le couvercle.
3. Rebranchez le four à l'alimentation électrique.

Veillez noter : Utilisez des ampoules à halogène de 25 W/230 V type G9, T300 °C. L'ampoule utilisée dans l'appareil est spécialement conçue pour les appareils électroménagers et ne convient pas pour l'éclairage d'une pièce de la maison (Règlement CE 244/2009).

Ces ampoules sont disponibles auprès de notre Service Après-vente. - Ne manipulez pas les ampoules à mains nues, les traces laissées par vos empreintes pourraient les endommager. Avant d'utiliser le four, assurez-vous que le couvercle de l'ampoule a bien été remis en place.

Hotpoint

ARISTON

CLICK TO CLEAN - NETTOYER LES VITRES

1. Après avoir enlevé la porte et l'avoir placée sur une surface matelassée, les poignées vers le bas, appuyez sur les deux fermetures en même temps et enlevez le bord supérieur de la porte en la tirant vers vous.

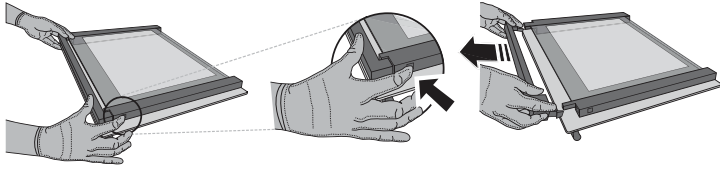

2. Soulevez et tenez fermement la vitre intérieure avec les deux mains, enlevez-la et placez-la sur une surface matelassée avant de la nettoyer.

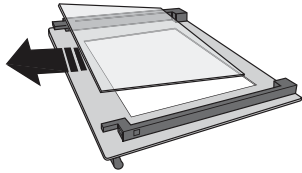

3. Réinstaller le panneau intermédiaire (marqué d'un "1R")

avant de replacer le panneau intérieur : Pour placer correctement les parois de verre, assurez-vous que la marque « R » se trouve dans le coin gauche. En premier, insérez la longue partie de la vitre marquée d'un « R » dans les appuis des guides, abaissez-la ensuite en place. Répétez cette procédure pour les deux parois de verre.

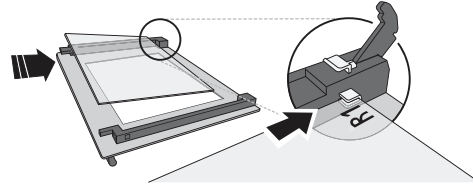

4. Remplacez le bord supérieur : un clique indique qu'elle est bien placée. Assurez-vous que le joint est bien placé avant de replacer la porte.

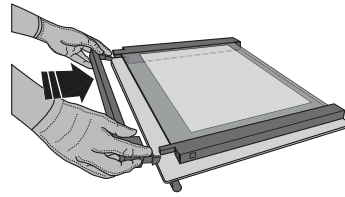

GUIDE DE DÉPANNAGE

PROBLÈME	CAUSE POSSIBLE	SOLUTION
Le four ne fonctionne pas.	Coupure de courant. Débranchez de l'alimentation principale.	Assurez-vous qu'il n'y a pas de panne de courant et que le four est bien branché. Éteignez puis rallumez le four pour voir si le problème persiste.
L'écran affiche la lettre « F » suivi d'un numéro ou d'une lettre.	Défaillance du four.	Prenez en note le numéro qui suit la lettre « F » et contactez le Service Après-vente le plus près.
L'écran affiche le message « Hot » et la fonction ne démarre pas.	Température trop élevée.	Laissez le four refroidir avant de lancer la fonction. Sélectionnez une fonction différente.



Vous pouvez télécharger les consignes de sécurité, le manuel de l'utilisateur, la fiche produit et les données énergétiques :

- En visitant notre site Web docs.hotpoint.eu
- En utilisant le code QR
- Vous pouvez également **contacter notre service après-vente** (voir numéro de téléphone dans le livret de garantie). Lorsque vous contactez notre Service après-vente, veuillez indiquer les codes figurant sur la plaque signalétique de l'appareil.

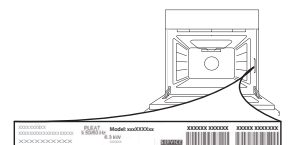

Hotpoint

ARISTON



400011708583

РЪКОВОДСТВО ЗА ВСЕКИДНЕВНА СПРАВКА



БЛАГОДАРИМ ВИ, ЧЕ ЗАКУПИХТЕ ПРОДУКТ НА HOTPOINT - ARISTON

За да получите по-пълно съдействие и поддръжка, регистрирайте Вашия уред на www.hotpoint.eu/register



Можете да свалите "Инструкции за безопасност" и "Ръководство за употреба и поддръжка" от нашия уебсайт docs.hotpoint.eu, както и да следвате указанията на задната корица на тази книжка.

! Преди да използвате уреда, прочетете внимателно ръководството за здраве и безопасност при работа.

ОПИСАНИЕ НА УРЕДА

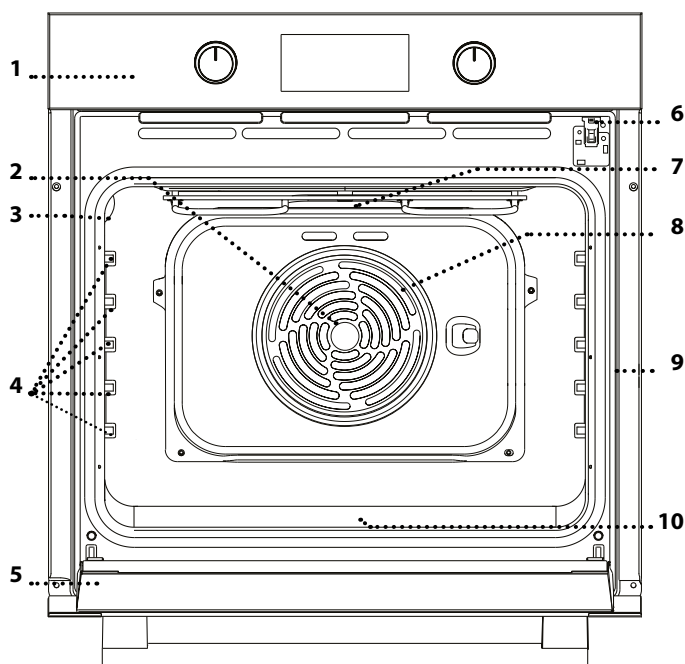

1. Контролен панел
2. Вентилатор
3. Лампа
4. Носачи (нивото е посочено на стената на отделението за готвене)
5. Вратичка
6. Заклучване на вратичката (заклучва вратичката, докато трае автоматичното почистване и след това)
7. Горен нагревател / Грил
8. Кръгъл нагревател (не се вижда)
9. Заводска табелка (не премахвайте)
10. steam място за наливане на вода

ОПИСАНИЕ НА КОНТРОЛНИЯ ПАНЕЛ

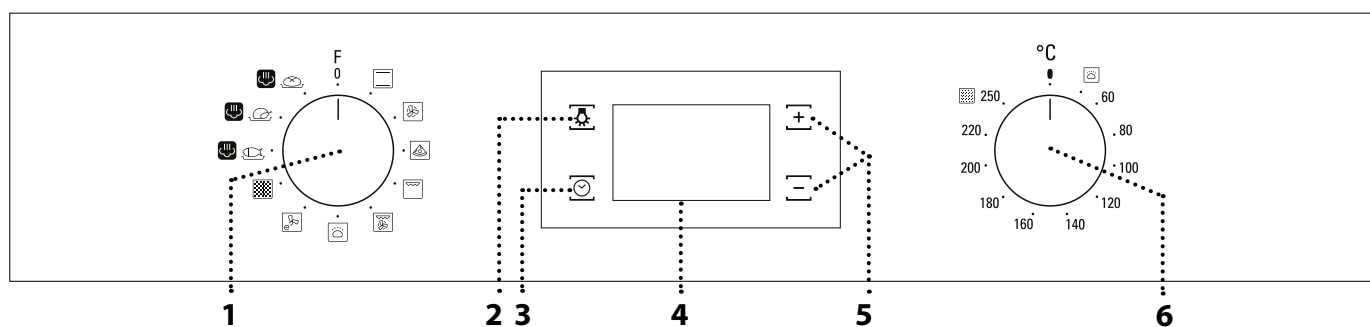

1. ВЪРТЯЩ СЕ БУТОН ЗА ИЗБИРАНЕ

За включване на фурната с избиране на функция. Завъртете на позиция 0, за да изключите фурната.

2. ОСВЕТЛЕНИЕ

При включена фурна натиснете , за да включите или изключите отделението на фурната.

3. НАСТРОЙКА НА ЧАСОВНИКА

За достъп до настройките на време за готвене, отложен старт и таймер.

За извеждане на часа, когато фурната е изключена.

4. ДИСПЛЕЙ

5. БУТОНИ ЗА РЕГУЛИРАНЕ

За промяна на настройките на време за готвене.

6. ВЪРТЯЩ СЕ БУТОН НА ТЕРМОСТАТА

Завъртете, за да изберете необходимата температура при активиране на ръчни функции.

ПРИНАДЛЕЖНОСТИ

РЕШЕТЪЧЕН РАФТ

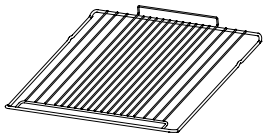

Използвайте за приготвяне на храна или като опора за тави, форми за кейкове и други огнеупорни готварски съдове.

ТАВА ЗА ОТЦЕЖДАНЕ*

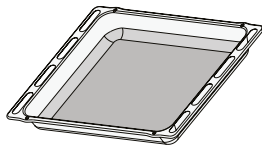

Използвайте като тава за фурна за приготвяне на месо, риба, зеленчуци, фокачи и др., или разположете под решетъчния рафт за отцеждане на сосовете при готвене.

ТАВА ЗА ПЕЧЕНЕ*

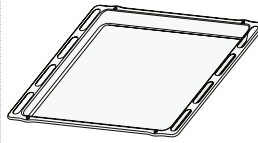

Използвайте за приготвяне на всички видове хляб и сладкиши, а също така и на печени меса, риба в пергамент и др.

ПЛЪЗГАЧИ *

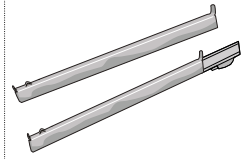

За улеснение на поставянето и изваждането на принадлежности.

* Налично само при определени модели

Броят и видът на принадлежностите може да е различен в зависимост от закупения модел.

Останалите принадлежности могат да се закупят от отдела за следпродажбено обслужване.

ПОСТАВЯНЕ НА РЕШЕТЪЧНИЯ РАФТ И ДРУГИТЕ ПРИНАДЛЕЖНОСТИ

. Поставете решетъчния рафт на необходимото ниво, като го хванете под лек наклон нагоре и първо подпрете повдигнатия заден край (насочен нагоре).

След това го плъзнете хоризонтално по водачите до възможно най-крайно положение.

. Останалите принадлежности, като тавата за печене, трябва да се поставят хоризонтално, като се плъзнат по носачите.

ИЗВАЖДАНЕ И ПОСТАВЯНЕ НА ВОДАЧИТЕ

. За да извадите водача, хванете здраво външната част на водача и го издърпайте към себе си, за да откачите опората и двата вътрешни щифта от гнездото им.

. За да поставите отново водачите, разположете ги близо до вътрешната част на фурната и първо вкарайте двата щифта в гнездата им. След това разположете външната част близо до гнездото ѝ, поставете опората и я натиснете към вътрешната стена, за да сте сигурни, че водачите са добре закрепени.

ЗАКРЕПЯНЕ НА ПЛЪЗГАЧИТЕ (АКО ИМА)

Свалете водачите. Откачете закрепящите скоби на водачите, като започнете от долната част.

За да поставите плъзгачите, закачете горната скоба на плъзгача за водача, след което спуснете другата скоба на мястото ѝ. За да закрепите водача, натиснете долната част на щипката здраво към водача. Проверете дали плъзгачите се движат свободно. Репозиционирайте водачите.

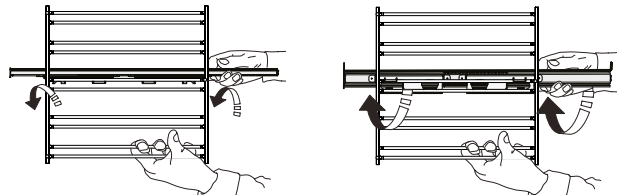

Моля имайте предвид: Плъзгачите могат да се монтират на кое да е ниво.

ФУНКЦИИ

КОНВЕНЦИОНАЛНО ГОТВЕНЕ

За готвене на всякакви ястия само на едно ниво.

ВЕНТИЛАТОР

За едновременно готвене на няколко ястия (най-много три) при една и съща температура на различни нива. Тази функция може да се използва за готвене на различни храни без преминаване на миризмите от едната храна към другата.

ПИЦА

За печене на пица и хляб с различни видове и размери. Добре е да се смени позицията на тавите за печене, след като половината от времето за готвене изтече.

ГРИЛ

За печене на грил на пържоли, кебап, наденици, приготвяне на зеленчуков огретен и препичане на хляб.

Когато печете месо, препоръчваме да използвате тавата за печене, за да събирате отделяните сокове: поставете тавата на някое от нивата под решетъчния рафт и налейте в нея 200 ml питейна вода.

ТУРБО ГРИЛ

За печене на едри парчета месо (джолан, говеждо печено, пиле). Препоръчваме да използвате тава за събиране на отделяните при готвенето сокове: поставете тавата на някое от нивата под решетъчния рафт и налейте в нея 200 ml питейна вода.

ВТАСВАНЕ

За добро втасване на сладко или ароматизирано тесто. За да активирате тази функция, завъртете *бутона на термостата* към иконата.

ЕКО ФОРСИРАН ВЪЗДУХ



За печене на едно ниво на парчета месо с плънка или без. Прекомерното изсъхване на храната се предотвратява поради слабата, прекъсваща от време на време циркулация на въздуха.

При използване на тази функция ЕКО лампичката не свети по време на готвенето, но може да се включи отново чрез натискане на бутона .

АВТОМАТИЧНО ПОЧИСТВАНЕ ЧРЕЗ ПИРОЛИЗА

За отстраняване на следите от пръски чрез цикъл с много висока температура (над 400°C).



steam 

- РИБА 
- МЕСО 
- ХЛЯБ 







Функциите steam  осигуряват отлични резултати благодарение на добавянето на пара към програмите за готвене. Когато фурната е студена, налейте питейна вода на дъното на фурната и изберете функцията, която отговаря на метода на приготвяне на храната. Оптималните количества и температури на водата за всяка категория храна са посочени в съответната готварска таблица. **Не загрявайте предварително фурната, преди да поставите храната.**

ИЗПОЛЗВАНЕ ЗА ПЪРВИ ПЪТ

1. НАСТРОЙКА НА ЧАСОВНИКА

Когато включите уреда за първи път, трябва да сверите часовника: Натискайте , докато иконата  и двете цифри за часа започнат да мигат на дисплея.





Чрез  или  сверете часа и потвърдете с . Двете цифри за минутите ще започнат да мигат. Чрез  или  сверете минутите и потвърдете с .



Моля, имайте предвид: Когато иконата  мига, например след дълго прекъсване на захранването, ще трябва да нулирате времето.

2. ЗАДАВАНЕ НА КОНСУМИРАНАТА МОЩНОСТ

Фурната е програмирана да работи с мощност, пониска от 2,9 kW ("Lo"): За да работи фурната с мощност, съвместима с електрозахранване в дома Ви, по-голямо от 3 kW ("Hi"), е необходимо да промените настройките. За да влезете в менюто за промяна на настройката, завъртете *бутона за избиране* на , след което го върнете обратно на 0.

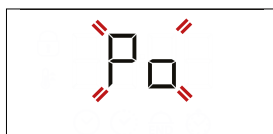
Веднага след това натиснете едновременно и задръжте за пет секунди  и .



Използвайте  или , за да промените настройката, след което натиснете и задръжте  за най-малко две секунди, за да потвърдите.

3. ЗАГРЯВАНЕ НА ФУРНАТА

Новата фурна може да изпуска миризми, останали от процеса на нейното производство: това е напълно нормално.

Преди да започнете да готвите храна във фурната, препоръчваме да я нагreete празна, за да премахнете остатъчните миризми.

Свалете предпазния картон или прозрачното фолие от фурната и извадете намиращите се в нея принадлежности.

Загрейте фурната до 250°C за около час. В това време фурната трябва да е празна.

Моля, имайте предвид: След първото използване на уреда се препоръчва да проветрите помещението.

ВСЕКИДНЕВНА УПОТРЕБА

1. ИЗБИРАНЕ НА ФУНКЦИЯ

За да изберете функцията, завъртете *бутона за избиране* до символа за необходимата функция: чува се звуков сигнал и дисплеят светва.



2. АКТИВИРАНЕ НА ФУНКЦИЯ

РЪЧЕН РЕЖИМ

За да стартирате избраната функция, завъртете *бутона на термостата* за задаване на необходимата температура.



Моля, имайте предвид: По време на готвене можете да промените функцията, като завъртите *бутона за избиране*, или да регулирате температурата, като завъртите *бутона на термостата*. Тази функция няма да започне, ако *бутонът на термостата* е на . Можете да зададете времето за готвене, крайния час за готвене (само ако зададете време за готвене) и таймер.

ВТАСВАНЕ

За да стартирате функцията "Втасване", завъртете *бутона на термостата* на съответния символ; ако фурната е зададена на друга температура, функцията няма да стартира.

Моля, имайте предвид: Можете да зададете времето за готвене, крайния час за готвене (само ако зададете време за готвене) и таймер.

steam

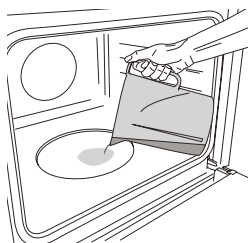

Когато фурната е студена, налейте посоченото в съответната готварска таблица количество вода в определеното за това място. Поставете храната във фурната.

Задаване и активиране на функцията steam : След края на програмата отворете внимателно вратичката и оставете парата да излезе постепенно.

Моля, имайте предвид: По време на готвене на пара не отваряйте вратичката и никога не доливайте вода.

3. ПРЕДВАРИТЕЛНО ЗАГРЯВАНЕ

След стартиране на функцията се чува звуков сигнал и на дисплея се показва мигаща икона , показваща, че фазата на предварително загряване е активирана.

Когато тази фаза приключи, се чува звуков сигнал и иконата свети непрекъснато на дисплея, за да покаже, че фурната е достигнала зададената температура: на този етап поставете продуктите във фурната и продължете с готвенето.

Моля, имайте предвид: Ако поставите храната във фурната преди предварителното загряване да завърши, качеството на приготвеното ястие може да се влоши.

. ПРОГРАМИРАНЕ НА ГОТВЕНЕТО

Ще е необходимо да изберете функцията, преди да стартирате програмирането на готвенето.

ПРОДЪЛЖИТЕЛНОСТ

Натискайте , докато иконата и „00:00“ започнат да мигат на дисплея.



Използвайте или , изберете необходимото време за готвене и след това натиснете , за да потвърдите.

За да активирате функцията, завъртете *бутона на термостата* до необходимата температура: чува се звуков сигнал и на дисплея се извежда информация, че готвенето е завършено.

Моля, имайте предвид: За да отмените зададеното време за готвене, натискайте , докато иконата започне да мига на дисплея, след което с помощта на нулирайте времето за готвене до „00:00“. Времето за готвене не включва фаза на подгриване.

ПРОГРАМИРАНЕ НА КРАЙНИЯ ЧАС НА ГОТВЕНЕ/ ОТЛОЖЕН СТАРТ

След като зададете време за готвене можете да отложите старта на функцията, като програмирате крайния час: натискайте , докато иконата и текущия час започнат да мигат на дисплея.



Чрез или задайте часа, в който искате да завърши готвенето, и потвърдете с .

За да активирате функцията, завъртете *бутона на термостата* до необходимата температура: функцията ще остане на пауза, докато стартира автоматично след периода от време, който е изчислен, за да завърши готвенето в зададения час.

Моля, имайте предвид: За да отмените настройката, изключете фурната, като завъртите *бутона за избиране* на позиция 0. Стартирането със закъснение не се предлага за функциите Grill и Turbo Grill.

КРАЙ НА ГОТВЕНЕТО

Чува се звуков сигнал и на дисплея се извежда информация, че функцията е завършена.

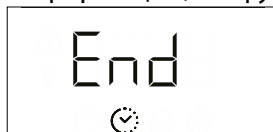



Завъртете *бутона за избиране*, за да изберете друга функция, или на позиция 0, за да изключите фурната.



Моля, имайте предвид: Ако таймерът работи, на дисплея ще се редува END и оставащото време.



. ПРОГРАМИРАНЕ НА ТАЙМЕРА

Тази опция не прекъсва или програмира готвенето, но ви позволява да използвате дисплея като таймер по време на работеща функция или при изключена фурна.

Натискайте , докато иконата  и „00:00“ започнат да мигат на дисплея.



Чрез  или  задайте необходимото време и потвърдете с . Когато зададеното време изтече, ще се чуе звуков сигнал.

Забележки: За да отмените таймера, натискайте , докато иконата  започне да мига, след което с помощта на  нулирайте времето до „00:00“.

. ФУНКЦИЯ Pyro ЗА АВТОМАТИЧНО ПОЧИСТВАНЕ

Не докосвайте фурната по време на пиролитичния цикъл.

Не допускайте деца и животни до фурната по време на пиролитичния цикъл и след това, до пълното проветряване на помещението.

Извадете всички принадлежности - включително и носачите - от фурната, преди да активирате функцията. Ако фурната е инсталирана под плот за готвене, всички горелки и електрически котлони трябва да са изключени по време на цикъла на самопочистване.

За оптимално почистване отстранете най-големите замърсявания с мокра гъба, преди да използвате функцията за пиролитично почистване.

При наличието на остатъци от котлен камък избягвайте да активирате почистващия цикъл с пиролиза Pyro.

Използвайте функцията Pyro само когато фурната е силно замърсена или отделя неприятна миризма по време на готвене.

За да активирате автоматичната почистваща функция, завъртете *бутона за избиране* и *бутона на термостата* до иконата . Функцията ще се активира автоматично, вратичката ще се заключи и осветлението във фурната ще изгасне: На дисплея се изписва оставащото време до края, което се редува с "Pyro".



След завършване на цикъла вратичката остава заключена, докато температурата вътре във фурната се върне до безопасно ниво.

Проветрявайте помещението по време на и след пиролитичния цикъл.

ГОТВАРСКА ТАБЛИЦА

РЕЦЕПТА	ФУНКЦИЯ	ПРЕДВАРИТЕЛНО ЗАГРЯВАНЕ	ТЕМПЕРАТУРА (°C)	ПРОДЪЛЖИТЕЛНОСТ (мин)	НИВО И ПРИНАДЛЕЖНОСТИ
Кейкове, замесени с мая		Да	170	30 - 50	3
		Да	160	30 - 50	2
		Да	160	40 - 60	4 1
Сладкиш с пълнеж (чийзкейк, щрудел, плодов пай)		Да	160 - 200	35 - 90	2
		Да	160 - 200	40 - 90	4 2
Бисквити / тарталети		Да	160	25 - 35	3
		Да	160	25 - 35	3
		Да	150	35 - 45	4 2
Сладкиши от парено тесто		Да	180 - 210	30 - 40	3
		Да	180 - 200	35 - 45	4 2
		Да	180 - 200	35 - 45	5 3 1
Целувки		Да	90	150 - 200	3
		Да	90	140 - 200	4 2
		Да	90	140 - 200	5 3 1
Пица / фокача		Да	190 - 250	15 - 50	1 / 2
		Да	190 - 250	20 - 50	4 2
Замразена пица		Да	250	10 - 20	3
		Да	230-250	10 - 25	4 2
Солени пайове (зеленчуков пай, киш)		Да	180 - 200	40 - 55	3
		Да	180 - 200	45 - 60	4 2
		Да	180 - 200	45 - 60	5 3 1
Сладки с пълнеж / хрупкави бисквити		Да	190 - 200	20 - 30	3
		Да	180 - 190	20 - 40	4 2
		Да	180 - 190	20 - 40	5 3 1
Лазаня / паста на фурна/ канелони / плодови пити		Да	190 - 200	45 - 65	2
Агнешко / Телешко / Говеждо / Свинско 1 kg		Да	190 - 200	80 - 110	3
Печено свинско с коричка 2 kg		Да	180 - 190	110 - 150	3
Пилешко / Заешко / Патешко 1 kg		Да	200 - 230	50 - 100	2
Пуйка / Гъска 3 kg		-	190 - 200	100 - 160	2
Риба на фурна / Риба, обвита в хартия за печене (филета, цяла)		Да	170 - 190	30 - 45	2

ФУНКЦИИ



Конвенционално готвене



Форсиран въздух



Пица



Грил



Турбо грил



Еко форсиран въздух

ПРИНАДЛЕЖНОСТИ



Решетъчен рафт



Тава за печене или форма за кейк на решетъчния рафт



Тава за печене/Тава за отцеждане или съд за печене на решетъчния рафт



Тава за отцеждане / Тава за печене



Тава за отцеждане / Тава за печене с 200 ml вода

РЕЦЕПТА	ФУНКЦИЯ	ПРЕДВАРИТЕЛНО ЗАГРЯВАНЕ	ТЕМПЕРАТУРА (°C)	ПРОДЪЛЖИТЕЛНОСТ (мин)	НИВО И ПРИНАДЛЕЖНОСТИ
Пълнени зеленчуци (домати, тиквички, патладжани)		Да	180 - 200	50 - 70	3
Препечен хляб		5'	250	2 - 6	5
Рибни филета / парчета		-	230 - 250	15 - 30 *	4 3
Наденици / Кебап / Ребра / Хамбургери		-	250	15 - 30 *	5 4
Печено пиле 1-1,3 kg		Да	200 - 220	55 - 70 **	2 1
Говеждо печено алангле 1 kg		Да	200 - 210	35 - 50 **	3
Агнешки бут / джолан		Да	200 - 210	60 - 90 **	3
Картофи на фурна		Да	200 - 210	35 - 55	2
Зеленчуков огретен		-	200 - 210	25 - 55	3
Месо и картофи		Да	190 - 200	45 - 100 ***	4 1
Риба и зеленчуци		Да	180	30 - 50 ***	4 2
Лазаня и месо		Да	200	50 - 100 ***	4 1
Пълно меню: плодов тарт (ниво 5) / лазаня (ниво 3) / месо (ниво 1)		Да	180 - 190	40 - 120 ***	5 3 1
Печено месо / пълнено месо за печене		-	170 - 180	100 - 150	3

* Обърнете храната при изтичане на половината от времето за готвене

** Обърнете храната при изтичане на две трети от времето за готвене.

*** Приблизителна продължителност на готвенето: може да извадите ястията от фурната по различно време в зависимост от личните Ви предпочитания.

steam

РЕЦЕПТА	ФУНКЦИЯ	ВОДА (ml)	ПРЕДВАРИТЕЛНО ЗАГРЯВАНЕ	ТЕМПЕРАТУРА (°C)	ПРОДЪЛЖИТЕЛНОСТ (мин)	НИВО И ПРИНАДЛЕЖНОСТИ
Рибни филета / стекове 0,5 - 2 cm	steam	250	-	190 - 210	15 - 25	3
Цяла риба 300 - 600 g	steam	250	-	190 - 210	15 - 30	3
Цяла риба (600 g - 1,2 kg)	steam	250	-	180 - 200	25 - 45	3
Говеждо печено алангле 1 kg	steam	250	-	190 - 210	40 - 55	3
Агнешки крачета 500 g - 1,5 kg	steam	250	-	170 - 190	60 - 75	2
Пиле / токачка / патица Цяла 1 - 1,5 kg	steam	250	-	200 - 220	55 - 75	2
Пиле / токачка / патица Парчета 500 g - 1,5 kg	steam	250	-	200 - 220	40 - 60	3
Пиле / пуйка / патица Цяла 3 kg	steam	250	-	160 - 180	100 - 140	2
Агнешко / Говеждо / Свинско 1 kg	steam	250	-	170 - 190	60 - 100	3
Хлебче 80 - 100 g	steam	200	-	200 - 220	30 - 45	3
Сандвич руло в тава 300 - 500 g	steam	250	-	170 - 190	45 - 60	3
Самун хляб 500 g - 2 kg	steam	250	-	160 - 170	50 - 100	2
Багети 200 - 300 g	steam	250	-	200 - 220	30 - 45	3

Посоченото време включва фазата на предварително загряване: препоръчително е да поставите храната във фурната и да зададете времето на готвене, когато стартирате функцията.

ФУНКЦИИ							steam	steam	steam
	Конвенционално готвене	Форсиран въздух	Пица	Грил	Турбо грил	Еко форсиран въздух	Риба	Месо	Хляб
ПРИНАДЛЕЖНОСТИ									
	Решетъчен рафт		Тава за печене или форма за кейк на решетъчния рафт	Тава за печене/Тава за отцеждане или съд за печене на решетъчния рафт		Тава за отцеждане / Тава за печене	Тава за отцеждане / Тава за печене с 200 ml вода		

ПОЧИСТВАНЕ И ПОДДРЪЖКА

Преди да пристъпите към поддръжка или почистване на фурната, се убедете, че не е гореща. Не използвайте уреди, почистващи с пара.

Не използвайте стоманена вълна, стъргалки или абразивни/разяждащи почистващи препарати, тъй като те могат да повредят повърхностите на уреда.

Носете предпазни ръкавици. Фурната трябва да се изключи от електрическата мрежа преди извършване на каквито и да е дейности по поддръжка.

ВЪНШНИ ПОВЪРХНОСТИ

Почистете повърхностите на фурната с влажна микрофибърна кърпа. Ако са силно замърсени, добавете няколко капки миеш препарат с неутрално рН. Забършете със суха кърпа.

Да не се използват корозивни или абразивни почистващи препарати. Ако подобен продукт случайно попадне върху повърхността на уреда, почистете незабавно с влажна микрофибърна кърпа.

ВЪТРЕШНИ ПОВЪРХНОСТИ

• След всяко използване изчакайте фурната да се охлади и я почистете, за предпочитане докато е още топла, за да отстраните отлаганията и петната, причинени от остатъците от храна. За да отстраните кондензираната влага при готвене на продукти с високо съдържание на вода, изчакайте фурната напълно да се охлади и след това я подсушете с кърпа или гъба.

• За да отстраните останалия по дъното на фурната накип след готвенето с steam, просто налейте 250 ml бял оцет в мястото за вода (като алтернатива можете да използвате препарат за премахване на котлен камък. За наличност на такъв препарат се свържете с отдела за следпродажбено обслужване).

Оставете да работи на стайна температура за 30 минути, след което почистете вътрешността на фурната с топла вода и мека кърпа. Препоръчително е да почиствате фурната най-малко на всеки 5 до 10 цикъла на готвене с функцията steam.

• Ако по вътрешните стени на фурната има засъхнала мръсотия, препоръчваме Ви да включите функцията за автоматично почистване с цел оптимални резултати от почистването. При наличието на остатъци от котлен камък избягвайте да активирате почистващия цикъл с пиролиза. Преди да активирате самопочистването, отстранете котления камък по описания по-нагоре начин.

• Вратичката може с лекота да се свали и постави обратно за по-лесно почистване на стъклото.

• Почистете стъклото на вратичката с подходящ течен препарат.

ПРИНАДЛЕЖНОСТИ

Веднага след употреба на киснетте принадлежностите във вода с добавен течен миеш препарат, като използвате ръкавици за фуна, ако принадлежностите все още са горещи. Остатъци от храна могат да се премахнат с помощта на четка или гъба.

СВАЛЯНЕ И ПОСТАВЯНЕ НА ВРАТИЧКАТА

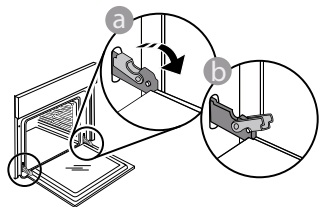

1. За да свалите вратичката, отворете я напълно и завъртете фиксаторите в отворено положение.

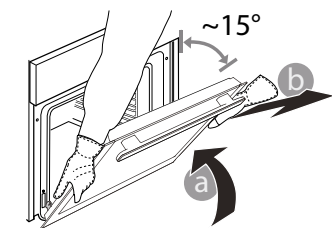

2. Затворете вратичката, доколкото е възможно. Хванете здраво вратичката с две ръце (не я хващайте за дръжката). Откачете вратичката, като я затворите още малко и същевременно я изтеглете нагоре, за да излезе от гнездата. Оставете вратичката на подходящо място върху мека повърхност.

3. За да поставите вратичката, първо я приблизете до фурната, след което вкарайте пантите в гнездата така, че да се фиксират в горната си част.

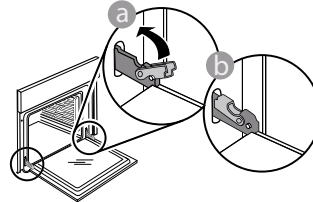

4. Спуснете вратичката надолу и я отворете докрай. Спуснете фиксаторите надолу до първоначалното им положение: Проверете дали фиксаторите са

спуснати докрай.

Натиснете леко, за да проверите дали фиксаторите са разположени правилно.

5. Пробвайте да затворите вратичката и проверете дали тя застава успоредно на контролния панел. Ако това не е така, повторете посочените по-горе стъпки. Вратичката може да се повреди, ако не функционира правилно.

СМЯНА НА ЛАМПАТА

1. Изключете фурната от електрозахранването.
2. Развийте капачката на осветителното тяло, сменете лампата и завийте отново капачката.
3. Свържете отново фурната към електрическата мрежа.

Моля, имайте предвид: Използвайте само халогенни лампи 25 W/230 V, тип G9, T300 °C. Лампата, използвана в изделието, е предназначена специално за домакински уреди и не е подходяща за осветяване на помещения в дома (Регламент на ЕО 244/2009).

Крушките могат да се закупят от нашия отдел за следпродажбено обслужване. - Не пипайте балона на лампата, тъй като оставащите по него отпечатащи могат да я повредят. Не използвайте фурната преди да поставите на място капачката на лампата.

CLICK & CLEAN - ПОЧИСТВАНЕ НА СТЪКЛАТА

1. След сваляне на вратичката и облягането ѝ на мека повърхност с дръжката надолу, едновременно натиснете двете задържащи щипки и отстранете горния ръб на вратичката, като го дръпнете към себе си.

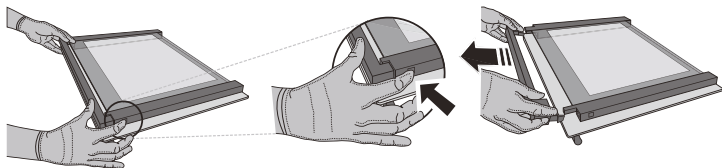

2. Повдигнете и хванете здраво вътрешното стъкло с две ръце, извадете го и го поставете върху мека повърхност, преди да го почиствате.

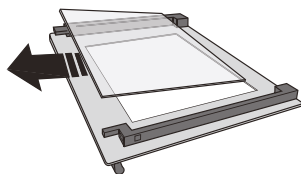

3. Поставете междинния панел (маркиран с "1R") преди да поставите вътрешния панел: За да сте сигурни, че сте поставили правилно стъклените панели, уверете се, че маркировката "R" се вижда в левия ъгъл. Първо поставете дългата страна на стъклото, обозначена с "R", в поддържащите гнезда, след това го спуснете на място. Повторете процедурата и за двата стъклени панела.

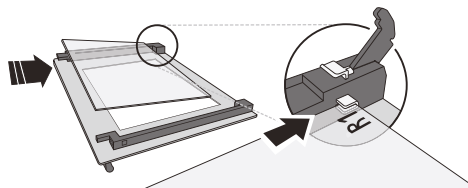

4. Закрепете горния ръб: позиционирането е правилно, когато чуete щракване. Уверете се, че уплътнението е надеждно, преди да поставите вратичката.

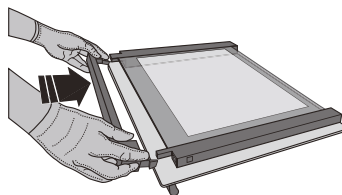

ОТКРИВАНЕ И ОТСТРАНЯВАНЕ НА НЕИЗПРАВНОСТИ

ПРОБЛЕМ	ВЪЗМОЖНА ПРИЧИНА	РЕШЕНИЕ
Фурната не работи.	Няма захранване с електроенергия. Уредът е изключен от мрежата.	Проверете дали има напрежение в мрежата и дали фурната е включена към мрежата. Изключете и включете уреда отново, за да видите дали проблемът не е отстранен.
На дисплея се извежда "F", последвано от цифри или букви.	Неизправност на фурната.	Свържете се с най-близкия център за следпродажбено обслужване на клиенти и съобщете числото след буквата F.
На дисплея се появява съобщението "Hot" и избраната функция не стартира.	Твърде висока температура.	Оставете фурната да се охлади, преди да активирате функцията. Изберете различна функция.

ЛИСТОВКА НА УРЕДА

[www](http://www.docs.hotpoint.eu) Листовката с енергийните показатели на този уред може да бъде свалена от нашия уебсайт docs.hotpoint.eu

КАК ДА СЕ СДОБИЕТЕ С РЪКОВОДСТВОТО ЗА УПОТРЕБА И ПОДДРЪЖКА

> [www](http://www.docs.hotpoint.eu) Свалете Ръководството за употреба и поддръжка от нашия уебсайт docs.hotpoint.eu (можете да използвате този QR код), като посочите кода на уреда.



> Можете също така да се свържете с нашия отдел за следпродажбено обслужване на клиенти.

СВЪРЗВАНЕ С ОТДЕЛА ЗА СЛЕДПРОДАЖБЕНО ОБСЛУЖВАНЕ

Информацията за контакт е приведена в ръководството за гаранционно обслужване. При контакт с отдела за следпродажбено обслужване на клиенти съобщавайте номерата, посочени на заводската табелка на Вашия уред.

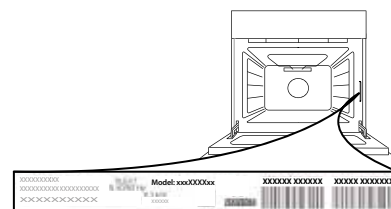

GUIA DE CONSULTA DIÁRIA

OBRIGADO POR ADQUIRIR UM PRODUTO HOTPOINT - ARISTON



Para receber uma assistência mais completa, registre o seu produto em www.hotpoint.eu/register



Pode transferir as Instruções de Segurança e o Guia de Utilização e Manutenção visitando o nosso website docs.hotpoint.eu e seguindo as instruções no verso do presente guia.



Antes de utilizar o produto, leia atentamente o Guia de Saúde e Segurança.

DESCRIÇÃO DO PRODUTO

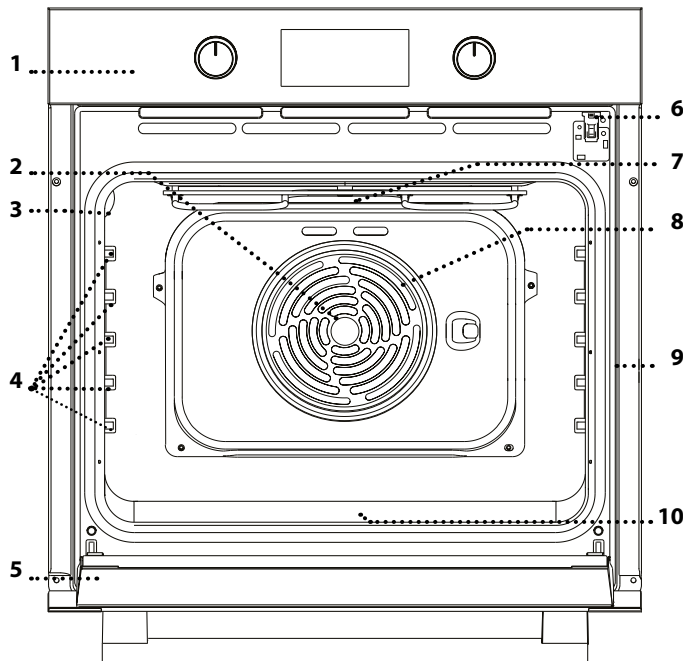

1. Painel de controlo
2. Ventoinha
3. Lâmpada
4. Guias de nível (o nível está indicado na parede do compartimento de cozedura)
5. Porta
6. Bloqueio da porta (tranca a porta durante e após a limpeza automática)
7. Resistência superior/grill
8. Resistência circular (não visível)
9. Placa de identificação (não remover)
10. steam reentrância para água potável

DESCRIÇÃO DO PAINEL DE CONTROLO

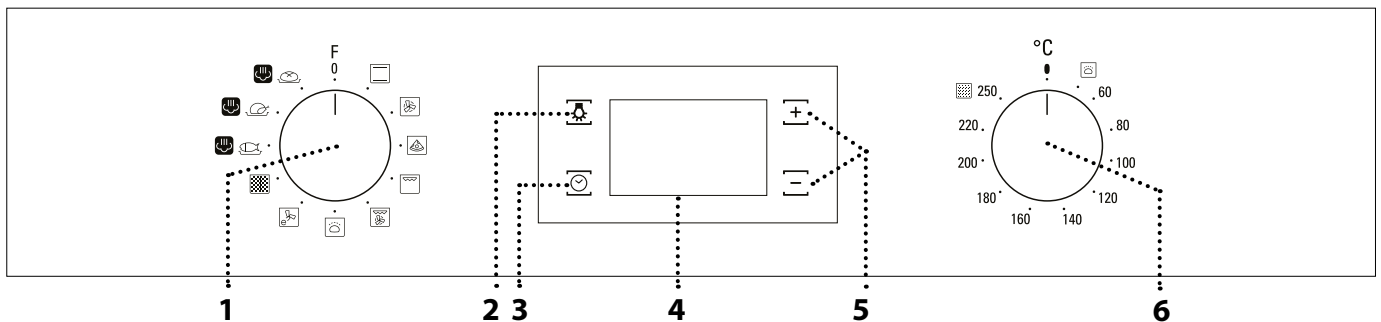

1. BOTÃO SELETOR

Para ligar o forno selecionando uma função. Para desligar o forno, rode o botão para a posição 0.

2. LUZ

Com o forno ligado, prima o botão  para ligar ou desligar a lâmpada do compartimento do forno.

3. ACERTAR A HORA

Para aceder às definições do tempo de cozedura, de início diferido e do temporizador.

Para apresentar o tempo em que o forno está desligado.

4. VISOR

5. BOTÕES DE AJUSTE

Para aceder às definições do tempo de cozedura.

6. BOTÃO DO TERMÓSTATO

Rode o botão para selecionar a temperatura pretendida ao ativar as funções manuais.

ACESSÓRIOS

GRELHA

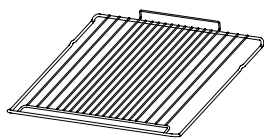

Adequadas para a cozedura de alimentos ou como suporte de recipientes de cozedura, formas para assar e quaisquer outros adequados para fornos.

TABULEIRO COLETOR *

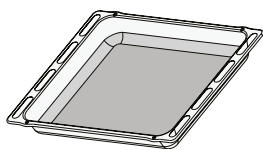

Para utilização como tabuleiro para cozinhar carne, peixe, legumes, focaccia, etc., ou para recolher sucos quando posicionado por baixo da grelha metálica.

TABULEIRO PARA ASSAR *

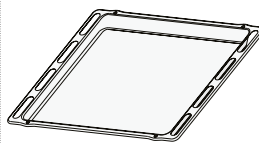

Para a cozedura de todos os produtos de padaria e pastelaria, mas também para assados, peixe em papelote, etc.

CALHAS DESLIZANTES*

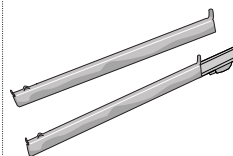

Para facilitar a inserção ou a remoção de acessórios.

* Disponível apenas em determinados modelos

O número e o tipo de acessórios pode variar de acordo com o modelo adquirido.

Pode adquirir separadamente outros acessórios no Serviço Pós-venda.

COMO INTRODUIZIR A GRELHA METÁLICA E OUTROS ACESSÓRIOS

. Insira a grelha metálica no nível pretendido, segurando-a e inclinando-a ligeiramente para cima; em seguida, pouse a parte traseira levantada (apontando para cima) primeiro.

Faça-a deslizar na horizontal pelos corredores tanto quanto possível.

. Os restantes acessórios, como o tabuleiro para assar, devem ser inseridos na horizontal, fazendo-os deslizar pelos corredores do forno.

RETIRAR E REPOR AS GUIAS DE NÍVEL

. Para retirar as guias de nível, segure a parte externa da guia e puxe-a na sua direção de forma a extrair o suporte e os dois pinos internos do alojamento.

. Para reposicionar as guias de nível, posicione-as junto à cavidade e comece por inserir os dois pinos nos seus alojamentos. De seguida, posicione a parte externa junto do seu alojamento, insira o suporte e pressione firmemente em direção à parede da cavidade de forma a garantir que a guia de nível se encontra devidamente presa.

COMO INSTALAR AS CALHAS DESLIZANTES (CASO EXISTAM)

Remova as guias de nível. Desencaixe os grampos de fixação da guia de nível, começando pela parte inferior.

Para reinstalar as guias deslizantes, prenda o grampo superior da guia à guia de nível e, de seguida, baixe o outro grampo até que este encaixe. Para fixar a guia, pressione a parte inferior do dispositivo de fixação firmemente contra a guia de nível. Assegure-se de que as corredeiras se movem livremente. Reponha as guias de nível.

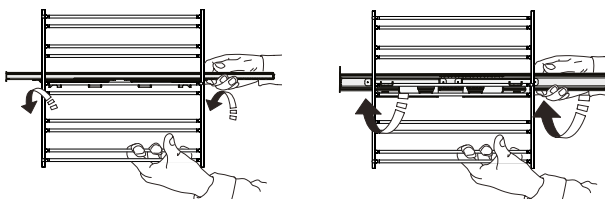

Lembre-se: As corredeiras podem ser instaladas em qualquer nível.

FUNÇÕES

CONVENCIONAL

Para cozinhar qualquer tipo de alimento utilizando apenas um nível.

AR FORÇADO

Para cozinhar alimentos diferentes que requerem a mesma temperatura de cozedura em diferentes prateleiras (máximo três) ao mesmo tempo. Esta função permite cozinhar alimentos diferentes sem transmitir odores de uns alimentos para os outros.

PIZZA

Para cozinhar diferentes tipos e formatos de pão e pizza. Recomendamos que troque a posição dos tabuleiros de assar a meio do processo de cozedura.

GRILL

Para grelhar bifes, espetadas, salsichas, gratinar legumes ou tostar pão.

Ao grelhar carne, recomendamos a utilização de um tabuleiro coletor, para recolher os sucos da cozedura: posicione o tabuleiro em qualquer um dos níveis que se encontram abaixo da grelha e adicione 200 ml de água potável.

TURBO GRILL

Para assar peças de carne grandes (pernil, rosbife, frango). Recomendamos a utilização de um tabuleiro coletor, para recolher os sucos da cozedura: posicione o tabuleiro em qualquer um dos níveis que se encontram abaixo da grelha e adicione 200 ml de água potável.

LEVEDURA

Para uma levedação eficaz de massas doces ou salgadas. Para ativar esta função rode o *botão do termóstato* para o respetivo ícone.

ECO AR FORCADO

Para assar peças de carne/peças de carne recheadas num único nível. Evita-se que os alimentos sequem excessivamente, através de uma circulação de ar suave e intermitente.

Quando esta função está a ser utilizada, a luz mantém-se apagada ao longo da cozedura, mas pode acender-se temporariamente, premindo .

LIMPEZA AUTOMÁTICA – LIMPEZA PIROLÍTICA

Para eliminar os salpicos de cozedura, utilizando um ciclo a muito alta temperatura (mais de 400 °C).



steam 

- PEIXE 
- CARNE 
- PÃO 







As funções steam  proporcionam excelentes resultados graças à adição de vapor aos ciclos de cozedura. Quando o forno estiver frio, deite água potável na base do forno e selecione a função correspondente ao seu método de preparação. As quantidades e temperaturas adequadas da água para cada categoria de comida indicadas na tabela de cozedura correspondente. **Não preaqueça o forno antes de adicionar a comida.**

UTILIZAR PELA PRIMEIRA VEZ

1. ACERTAR A HORA

Ao ligar o aparelho pela primeira vez, terá de definir a hora: prima  até que o ícone  e os dois dígitos da hora comecem a piscar no visor.





Utilize  ou  para acertar a hora e prima  para confirmar. Os dois dígitos dos minutos começam a piscar. Utilize  ou  para definir os minutos e prima  para confirmar.

Lembre-se: Quando o ícone  está a piscar, por exemplo, durante cortes de energia prolongados, é necessário acertar a hora.



2. DEFINIR O CONSUMO DE ENERGIA

O forno está programado para funcionar com uma potência inferior a 2,9 kW ("Lo"): Para utilizar o forno com uma potência que seja compatível com uma alimentação elétrica doméstica superior a 3 kW ("Hi"), será necessário alterar as definições do mesmo.

Para alterar as definições, aceda ao respetivo menu, rode o *botão seletor* para  e, em seguida, rode-o novamente para 0.

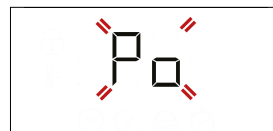
Logo de seguida, prima e mantenha premido  e  durante cinco segundos seguintes.



Prima  ou  para alterar as definições e, em seguida, prima e mantenha premido  durante, pelo menos, dois segundos para confirmar.

3. AQUECER O FORNO

Um forno novo pode libertar odores residuais, resultantes do processo de fabrico: isto é perfeitamente normal.

Assim, antes de começar a cozinhar alimentos, recomendamos que aqueça o forno, vazio, para eliminar eventuais odores.

Remova do forno qualquer elemento de proteção em cartão ou película transparente e retire quaisquer acessórios do respetivo interior.

Aqueça o forno até aos 250 °C durante uma hora, aproximadamente. Durante este período de tempo, o forno deverá estar vazio.

Lembre-se: É aconselhável arejar a cozinha após a primeira utilização do aparelho.

UTILIZAÇÃO DIÁRIA

1. SELECIONAR UMA FUNÇÃO

Para selecionar uma função, rode o *botão seletor* para o símbolo da função que pretende selecionar: o visor acende-se e ouve-se um sinal sonoro.



2. ATIVAR UMA FUNÇÃO

MANUAL

Para iniciar a função selecionada, rode o *botão do termóstato* para definir a temperatura requerida.



Lembre-se: Durante a cozedura é possível e alterar a função rodando o *botão seletor* ou regular a temperatura rodando o *botão do termóstato*. A função só é iniciada se o *botão do termóstato* estiver na posição 0. Pode definir o tempo de cozedura, o tempo de fim da cozedura (apenas se selecionar um tempo de cozedura) e um temporizador.

LEVEDURA

Para dar início à função "Levedura", rode o *botão do termóstato* até ao ícone relevante; Se o forno tiver uma temperatura diferente definida, a função não será iniciada.

Lembre-se: Pode definir o tempo de cozedura, o tempo de fim da cozedura (apenas se selecionar um tempo de cozedura) e um temporizador.

steam:

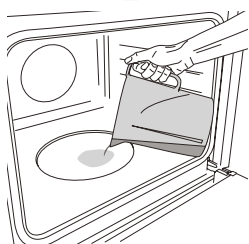

Quando o forno estiver frio, encha a reentrância com a quantidade de água potável sugerida na tabela de cozedura relevante. Coloque os alimentos no forno.

Configure e ative a função steam: : No final, abra cuidadosamente a porta e deixe o vapor sair lentamente.

Lembre-se: Nunca abra a porta ou coloque água em excesso (até ao topo) durante a cozedura a vapor.

3. PRAQUECIMENTO

Uma vez iniciada a função, é emitido um sinal sonoro e o ícone a piscar no visor indica que a fase de preaquecimento foi ativada.

Terminada a fase de preaquecimento, é emitido um sinal sonoro e o ícone fixo no visor indicam que o forno atingiu a temperatura definida: nessa altura, coloque os alimentos no interior do forno e dê início à cozedura.

Lembre-se: Colocar os alimentos no forno antes de o preaquecimento estar concluído pode ter um efeito adverso no resultado final da cozedura.

PROGRAMAR A COZEDURA

É necessário selecionar uma função antes de programar a cozedura.

DURAÇÃO

Mantenha o ícone premido até que o ícone e a indicação "00:00" comece a piscar no visor.



Utilize ou para definir o tempo de cozedura pretendido e, em seguida, prima para confirmar. Ative a função rodando o *botão do termóstato* para a temperatura requerida: é emitido um sinal sonoro e o visor indica que a cozedura está concluída.

Lembre-se: Para cancelar o tempo de cozedura definido, mantenha premido o botão até que o ícone comece a piscar no visor e, em seguida, prima para repor o tempo de cozedura para "00:00". Este tempo de cozedura inclui uma fase de preaquecimento.

PROGRAMAR O TEMPO DE FIM/ INÍCIO DIFERIDO DA COZEDURA

Após definir um tempo de cozedura, o início da função pode ser diferido, programando o tempo de fim: prima até que o ícone e a hora atual comecem a piscar no visor.



Utilize ou para definir o tempo de fim da cozedura pretendido e, em seguida, prima para confirmar.

Ative a função rodando o *botão do termóstato* para a temperatura requerida: a função irá permanecer em pausa até ser iniciada automaticamente após o período de tempo calculado para concluir a cozedura à hora programada.

Lembre-se: Para cancelar a definição, desligue o forno rodando o *botão seletor* para a posição 0.

FIM DA COZEDURA

É emitido um sinal sonoro e o visor indica que a função está concluída.





Rode o *botão seletor* para selecionar uma outra função ou para 0 para desligar o forno.



Lembre-se: Caso o temporizador esteja ativado, o visor indica a mensagem "END" alternada com o tempo restante.

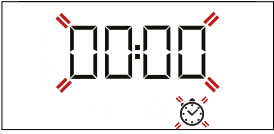

. PROGRAMAR O TEMPORIZADOR

Esta opção não interrompe, nem programa a cozedura mas permite-lhe utilizar o visor como temporizador, quer enquanto uma função está ativada, quer quando o forno está desligado.

Mantenha o ícone  premido até que os ícones  e "00:00" comecem a piscar no visor.



Utilize  ou  para definir o tempo pretendido e prima  para confirmar. Quando o temporizador terminar a contagem decrescente do tempo programado, ouvir-se-á um sinal sonoro.

Notas: Para cancelar o temporizador, mantenha premido o botão  até que o ícone  comece a piscar e, em seguida, utilize  para repor o tempo para "00:00".

. LIMPEZA AUTOMÁTICA – LIMPEZA PIROLÍTICA

Não toque no forno durante o ciclo de limpeza pirolítica. Mantenha crianças e animais afastados do forno durante e após (até a divisão ter arejado totalmente) a execução do ciclo de limpeza pirolítica.

Retire os acessórios do forno, incluindo as guias de nível, antes de ativar esta função. Se o forno estiver instalado por baixo de uma placa, assegure-se de que, durante a execução do ciclo de limpeza automática, os queimadores ou as placas elétricas estão desligados.

Para obter os melhores resultados de limpeza, elimine a sujidade maior com uma esponja húmida antes de utilizar a função de limpeza pirolítica.

Evite ativar o ciclo de limpeza pirolítica na presença de resíduos de calcário.

Recomendamos a utilização da função de Limpeza pirolítica apenas se o aparelho estiver muito sujo ou libertar maus odores durante a cozedura.

Para ativar a função de limpeza automática, rode o *botão seletor* e o *botão do termóstato* para o ícone . A função é ativada automaticamente, a porta tranca-se e a luz do interior do forno apaga-se: o visor apresenta o tempo restante até ao final da cozedura alternado com a mensagem "Limpeza pirolítica".



Uma vez concluído o ciclo, a porta permanece trancada até que a temperatura no interior do forno tenha baixado para um nível seguro. Areje a divisão durante e após a execução de um ciclo de limpeza pirolítica.

TABELA DE COZEDURA

RECEITA	FUNÇÃO	PREAQUECI- MENTO	TEMPERATURA (°C)	DURAÇÃO (Min.)	NÍVEL E ACESSÓRIOS
Bolos com levedura		Sim	170	30 - 50	3
		Sim	160	30 - 50	2
		Sim	160	40 - 60	4 1
Bolo recheado (cheesecake, strudel, tarte de frutas)		Sim	160 - 200	35 - 90	2
		Sim	160 - 200	40 - 90	4 2
Biscoitos/queques		Sim	160	25 - 35	3
		Sim	160	25 - 35	3
		Sim	150	35 - 45	4 2
Massa choux		Sim	180 - 210	30 - 40	3
		Sim	180 - 200	35 - 45	4 2
		Sim	180 - 200	35 - 45	5 3 1
Merengues		Sim	90	150 - 200	3
		Sim	90	140 - 200	4 2
		Sim	90	140 - 200	5 3 1
Pizza/Focaccia		Sim	190 - 250	15 - 50	1 / 2
		Sim	190 - 250	20 - 50	4 2
Pizza congelada		Sim	250	10 - 20	3
		Sim	230-250	10 - 25	4 2
Bolos salgados (tarte de legumes, quiche)		Sim	180 - 200	40 - 55	3
		Sim	180 - 200	45 - 60	4 2
		Sim	180 - 200	45 - 60	5 3 1
Vol-au-vents/salgadinhos de massa folhada		Sim	190 - 200	20 - 30	3
		Sim	180 - 190	20 - 40	4 2
		Sim	180 - 190	20 - 40	5 3 1
Lasanha/massa no forno/ canelones/flans		Sim	190 - 200	45 - 65	2
Borrego / vitela / vaca / porco 1 kg		Sim	190 - 200	80 - 110	3
Lombo assado estaladiço 2 kg		Sim	180 - 190	110 - 150	3
Frango/coelho/pato 1 kg		Sim	200 - 230	50 - 100	2
Peru / ganso 3 kg		-	190 - 200	100 - 160	2
Peixe no forno / em papelote (filetes, inteiro)		Sim	170 - 190	30 - 45	2
Legumes recheados (tomates, curgetes, beringelas)		Sim	180 - 200	50 - 70	3

FUNÇÕES

Convencional

Ar forçado

Pizza

Grill

Turbo Grill

Eco ar forçado

ACESSÓRIOS

Grelha

Tabuleiro para assar ou forma de bolos na grelha

Tabuleiro para assar / tabuleiro coletor ou forma para assar na grelha

Tabuleiro coletor / tabuleiro para assar

Tabuleiro coletor / tabuleiro para assar com 200 ml de água

RECEITA	FUNÇÃO	PREAQUECI- MENTO	TEMPERATURA (°C)	DURAÇÃO (Min.)	NÍVEL E ACESSÓRIOS
Pão tostado		5'	250	2 - 6	5
Filetes/postas de peixe		-	230 - 250	15 - 30 *	4 3
Salsichas/espetadas/ costeletas/hambúrgueres		-	250	15 - 30 *	5 4
Frango assado 1-1,3 kg		Sim	200 - 220	55 - 70 **	2 1
Rosbife mal passado 1 kg		Sim	200 - 210	35 - 50 **	3
Perna de borrego/pernis		Sim	200 - 210	60 - 90 **	3
Batatas assadas		Sim	200 - 210	35 - 55	2
Gratinado legumes		-	200 - 210	25 - 55	3
Carne e batatas		Sim	190 - 200	45 - 100 ***	4 1
Peixe e legumes		Sim	180	30 - 50 ***	4 2
Lasanha e carne		Sim	200	50 - 100 ***	4 1
Refeição completa: Tarte de frutas (nível 5) / lasanha (nível 3) / carne (nível 1)		Sim	180 - 190	40 - 120 ***	5 3 1
Carne assada/carne assada recheada		-	170 - 180	100 - 150	3

*Vire o alimento a meio da cozedura

**Vire o alimento quando atingir dois terços do tempo de cozedura (se necessário).

***Período de tempo estimado: Os alimentos podem ser retirados do forno quando o desejar, dependendo da preferência de cada um.

steam

RECEITA	FUNÇÃO	ÁGUA (ml)	PREAQUECI- MENTO	TEMPERATURA (°C)	DURAÇÃO (Min.)	NÍVEL E ACES- SÓRIOS
Filetes de peixe / costeletas 0,5 - 2 cm	steam	250	-	190 - 210	15 - 25	3
Peixe inteiro 300 g - 600 kg	steam	250	-	190 - 210	15 - 30	3
Peixe inteiro 600 g - 1,2 kg	steam	250	-	180 - 200	25 - 45	3
Rosbife mal passado 1 kg	steam	250	-	190 - 210	40 - 55	3
Perna de borrego 500 g - 1,5 kg	steam	250	-	170 - 190	60 - 75	2
Frango / galinha-d'angola / pato Inteiro 1 - 1,5 kg	steam	250	-	200 - 220	55 - 75	2
Galinha / galinha d'angola / pato Pedacos de 500 g - 1,5 kg	steam	250	-	200 - 220	40 - 60	3
Galinha / peru / pato Inteiro 3 kg	steam	250	-	160 - 180	100 - 140	2
Borrego / vaca / porco 1 kg	steam	250	-	170 - 190	60 - 100	3
Pão pequeno 80 - 100 g	steam	200	-	200 - 220	30 - 45	3
Sandes de pão de forma 300 - 500 g	steam	250	-	170 - 190	45 - 60	3
Pão 500 g - 2 kg	steam	250	-	160 - 170	50 - 100	2
Baguetes 200 - 300 g	steam	250	-	200 - 220	30 - 45	3

O tempo indicado inclui a fase de preaquecimento: recomendamos que coloque os alimentos no forno e defina o tempo de cozedura antes de iniciar a função.

FUNÇÕES							steam	steam	steam
	Convencional	Ar forçado	Pizza	Grill	Turbo Grill	Eco ar forçado	Peixe	Carne	Pão
ACESSÓRIOS									
	Grelha	Tabuleiro para assar ou forma de bolos na grelha	Tabuleiro para assar / tabuleiro coletor ou forma para assar na grelha	Tabuleiro coletor / tabuleiro para assar	Tabuleiro coletor / tabuleiro para assar	Tabuleiro coletor / tabuleiro para assar com 200 ml de água			

LIMPEZA E MANUTENÇÃO

Assegure-se de que o forno arrefece antes de executar qualquer operação de manutenção ou limpeza.

Não utilize aparelhos de limpeza a vapor.

Não utilize um acessório de palha de aço, esfregões abrasivos ou produtos de limpeza abrasivos/corrosivos, pois estes podem danificar as superfícies do aparelho.

Use luvas de proteção.

O forno tem de ser desligado da rede elétrica antes da realização de qualquer tipo de trabalho de manutenção.

SUPERFÍCIES EXTERIORES

Limpe as superfícies com um pano de microfibra húmido. Se estiverem muito sujas, acrescente alguns pingos de detergente com um pH neutro. Termine a limpeza com um pano seco.

Não utilize detergentes corrosivos ou abrasivos. Se algum destes produtos entrar inadvertidamente em contacto com as superfícies do aparelho, limpe-as imediatamente com um pano de microfibra húmido.

SUPERFÍCIES INTERIORES

• Após cada utilização, deixe que o forno arrefeça e limpe-o, de preferência enquanto estiver morno, para remover eventuais depósitos ou manchas causados por resíduos de alimentos. Para secar qualquer condensação que se tenha formado devido à cozedura de alimentos com elevado teor de água, deixe o forno arrefecer completamente e limpe-o com um pano ou uma esponja.

• Para remover o restante calcário do fundo da cavidade do forno após a cozedura steam (☁), basta adicionar 250 ml de vinagre branco na marca em relevo da cavidade (em alternativa, utilize um produto descalcificante específico). Para consultar a disponibilidade, contacte o

Serviço Pós-venda).

Deixe atuar à temperatura ambiente durante 30 minutos e, em seguida, limpe a cavidade com água potável morna e um pano macio. A limpeza é recomendável a cada 5 a 10 ciclos de cozedura steam (☁).

• Em caso de sujidade persistente no interior do forno, recomendamos a execução da função de limpeza automática para obter os melhores resultados de limpeza. Evite ativar o ciclo de limpeza pirolítica na presença de resíduos de calcário. Antes de ativar, realize uma limpeza do calcário de acordo com os procedimentos acima.

• A porta pode ser removida facilmente e instalada novamente para facilitar a limpeza do vidro.

• Limpe o vidro da porta com um detergente líquido adequado.

ACESSÓRIOS

Após a utilização, coloque os acessórios numa solução líquida de limpeza, pegando nos mesmos com luvas de forno, caso ainda estejam quentes. Os restos de alimentos podem ser retirados com uma esponja ou escova de limpeza.

REMOVER E REPOR A PORTA

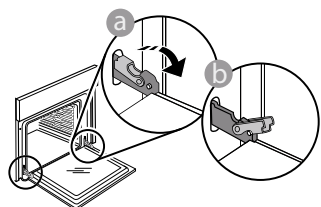

Para remover a porta, abra-a totalmente e baixe as linguetas até ficarem na posição de desbloqueio.

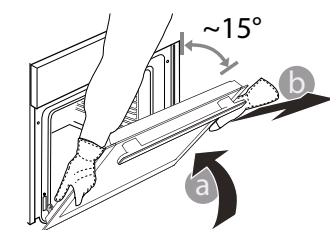

2. Feche a porta tanto quanto possível. Segure firmemente a porta com ambas as mãos – não a segure pela pega. Remova, simplesmente, a porta, continuando a fechá-la enquanto a puxa, simultaneamente, para cima,

até se libertar do respetivo suporte. Coloque a porta de parte, apoiando-a sobre uma superfície suave.

3. Reponha a porta, deslocando-a na direção do forno e alinhando os ganchos das dobradiças com os respetivos suportes, fixando a parte superior aos suportes.

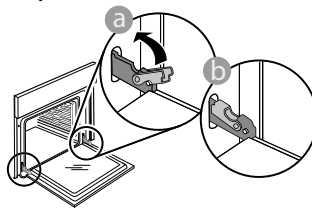

4. Baixe a porta e, em seguida, abra-a totalmente. Baixe as linguetas para a respetiva posição original: Assegure-se de que as baixe totalmente.

Aplique uma pressão suave, para se assegurar de que as linguetas estão na posição correta.

5. Tente fechar a porta e assegure-se de que está alinhada com o painel de controlo. Se não estiver, repita os procedimentos acima: A porta poderá ficar danificada se não funcionar corretamente.

SUBSTITUIR A LÂMPADA

1. Desligue o forno da corrente elétrica.
2. Desaperte a cobertura da lâmpada, substitua a lâmpada e aperte novamente a cobertura da mesma.
3. Ligue o forno novamente à corrente elétrica.

Lembre-se: Utilize lâmpadas de halogéneo 25 W/230 V tipo G9, T300 °C. A lâmpada utilizada no produto foi especificamente concebida para eletrodomésticos e não é adequada para a iluminação geral de divisões da casa (Regulamento CE 244/2009). As lâmpadas estão disponíveis no nosso Serviço Pós-Venda. - Não manuseie as lâmpadas com as mãos desprotegidas, uma vez que as suas impressões digitais podem danificá-las. Não utilize o forno até que a cobertura da lâmpada tenha sido repostada.

CLICK & CLEAN - LIMPAR OS VIDROS

1. Após remover a porta e pousá-la sobre superfície suave, prima simultaneamente os dois grampos de retenção e remova a extremidade superior da porta, puxando-a na sua direção.

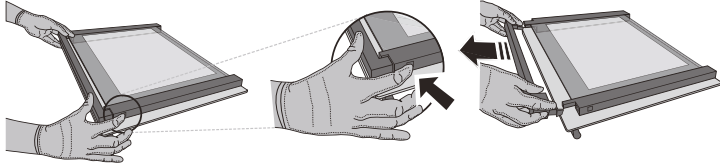

2. Levante e segure firmemente o vidro interior com ambas as mãos, removendo-o e colocando-o sobre uma superfície suave antes de proceder à sua limpeza.

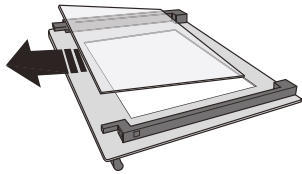

3. Reinstale o painel intermédio (com a marca "1R") antes de instalar o painel interior: Para posicionar os painéis de vidro corretamente, certifique-se de que é possível visualizar a marca "R" no canto esquerdo. Insira primeiro a parte mais longa do vidro com a indicação "R" nos suportes e, em seguida, baixe-a até à posição correta. Repita este procedimento para ambos os painéis de vidro.

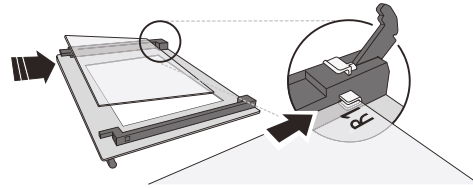

4. Instale novamente a extremidade superior: irá ouvir um clique, indicando que está bem posicionado. Certifique-se de que a vedação está segura antes de montar novamente a porta.

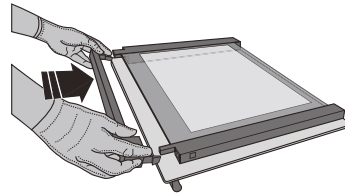

RESOLUÇÃO DE PROBLEMAS

PROBLEMA	CAUSA POSSÍVEL	SOLUÇÃO
O forno não está a funcionar.	Corte de energia. Desativação da rede elétrica.	Verifique se existe energia elétrica proveniente da rede e se o forno está ligado à tomada elétrica. Desligue e volte a ligar o forno, para verificar se o problema ficou resolvido.
O visor apresenta a letra "F", seguida de um número ou uma letra.	Falha do forno.	Contacte o seu Serviço Técnico de Pós-Venda mais próximo e indique o número que acompanha a letra "F".
O visor apresenta a mensagem "Hot" (Quente) e a função selecionada não é iniciada.	Temperatura demasiado alta.	Deixe o forno arrefecer antes de ativar a função. Selecione uma outra função.

FICHA DE PRODUTO

 A ficha do produto, incluindo os dados energéticos para este aparelho, pode ser transferida a partir do website **docs.hotpoint.eu**

COMO OBTER O GUIA DE UTILIZAÇÃO E MANUTENÇÃO

>  Transfira o Guia de Utilização e Manutenção a partir do nosso website **docs.hotpoint.eu** (pode utilizar este código QR), especificando o código comercial do produto.



> Em alternativa, contacte o nosso Serviço Pós-Venda.

CONTACTAR O NOSSO SERVIÇO PÓS-VENDA

Pode encontrar os nossos contactos no manual de garantia. Ao contactar o nosso Serviço Pós-Venda, indique os códigos fornecidos na placa de identificação do seu produto.

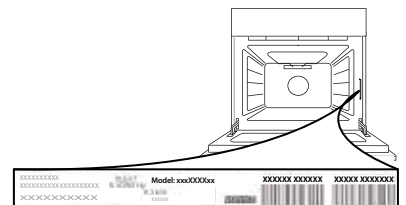



GRACIAS POR COMPRAR UN PRODUCTO HOTPOINT-ARISTON

Para recibir una asistencia más completa, registre su producto en www.hotpoint.eu/register



Antes de usar el aparato, lea atentamente las Instrucciones de seguridad.

DESCRIPCIÓN DEL PRODUCTO

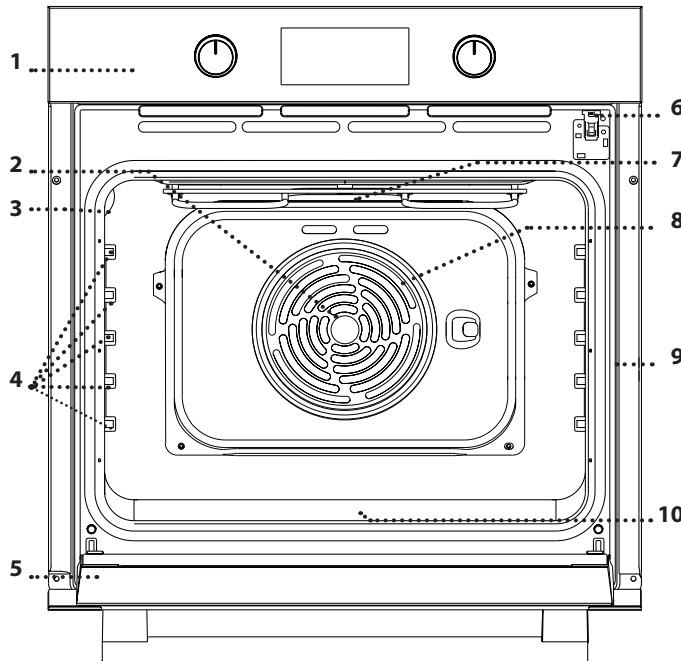

1. Panel de control
2. Ventilador
3. Lámpara
4. Guías para estantes (el nivel está indicado en la pared del compartimento de cocción)
5. Puerta
6. Bloqueo de la puerta (bloquean la puerta durante el proceso de limpieza automática y después del mismo)
7. Resistencia superior / grill
8. Resistencia circular (no visible)
9. Placa de características (no debe retirarse)
10. steam:☁ cavidad para agua potable

DESCRIPCIÓN DEL PANEL DE CONTROL

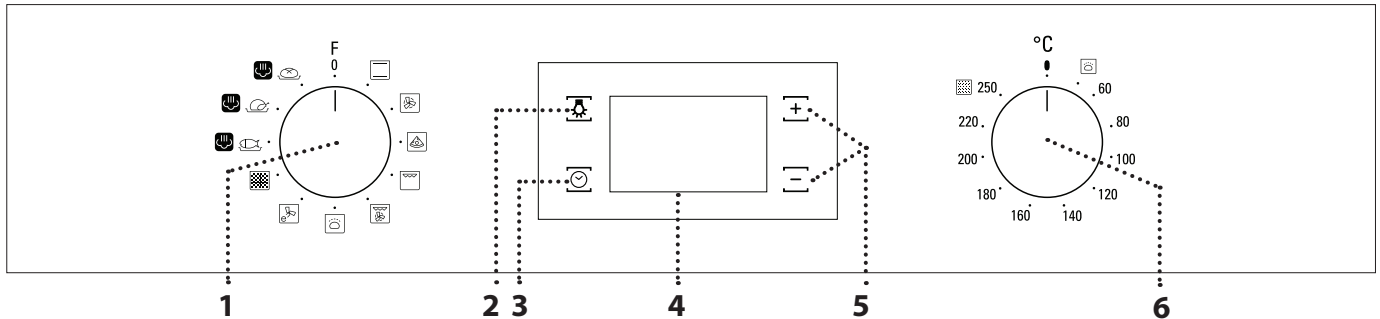

1. SELECTOR

Para encender el horno seleccionando una función. Gírelo hasta la posición 0 para apagar el horno.

2. Luz

Con el horno encendido, pulse  para apagar o encender la bombilla del compartimento del horno.

3. AJUSTE DE LA HORA

Para acceder a la configuración del tiempo de cocción, el inicio diferido y el temporizador.

Para mostrar la hora cuando el horno está apagado.

4. PANTALLA

5. BOTONES DE REGULACIÓN

Para cambiar la configuración del tiempo de cocción.

6. SELECTOR DEL TERMOSTATO

Gire para seleccionar la temperatura deseada cuando active las funciones manuales.

ACCESORIOS

REJILLA

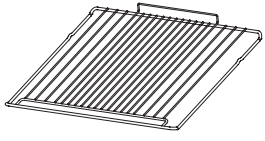

Para cocinar alimentos o como soporte de cazuelas, moldes de tartas y otros recipientes de cocción aptos para horno.

GRASERA *

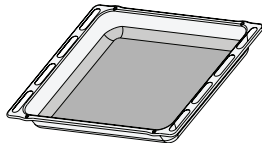

Para utilizar como bandeja de horno para cocinar carne, pescado, verduras, focaccia, etc. o para recoger los jugos de la cocción debajo de la rejilla.

BANDEJA PASTELERA *

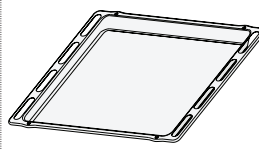

Se utiliza para pan y pasteles, pero también para asados, pescado en papillote, etc.

GUÍAS DESLIZANTES *

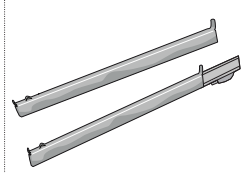

Para facilitar la inserción y extracción de accesorios.

* Disponible en determinados modelos solamente

El número y el tipo de accesorios puede variar dependiendo del modelo comprado.

Se pueden adquirir otros accesorios por separado en el Servicio Postventa.

INTRODUCCIÓN DE LA REJILLA Y OTROS ACCESORIOS

. Introduzca la rejilla en el nivel que desee, manteniéndola ligeramente inclinada hacia arriba y apoyando primero la parte trasera elevada (orientada hacia arriba).

Luego desplácela horizontalmente por las guías hasta el tope.

. Otros accesorios, como la bandeja pastelera, se deben introducir horizontalmente, dejando que se deslicen por las guías.

CÓMO EXTRAER Y VOLVER A COLOCAR LAS GUÍAS PARA ESTANTES

. Para extraer las guías para estantes, sujete firmemente la parte externa de la guía y tire hacia usted para extraer el soporte y las dos clavijas internas del alojamiento.

. Para volver a colocar las guías para estantes, colóquelas cerca de la cavidad e introduzca primero las dos clavijas en sus alojamientos. Luego, coloque la parte externa cerca de su alojamiento, introduzca el soporte y presione firmemente hacia la pared de la cavidad para asegurarse de que la guía para estantes quede bien sujeta.

MONTAJE DE LAS GUÍAS DESLIZANTES (SI PROCEDE)

Extraiga las guías para estantes. Desenganche los cierres de anclaje de la guía para estantes empezando por la parte inferior.

Para volver a colocar las guías de deslizamiento, ancle el cierre superior de la guía a la guía para estantes, después baje el otro cierre hasta su posición. Para fijar la guía, empuje la parte inferior del cierre contra la guía para estantes. Asegúrese de que las guías se pueden mover libremente. Vuelva a colocar las guías para estantes.

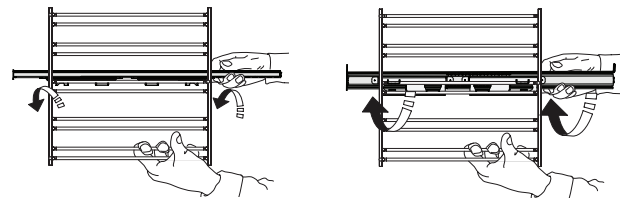

Nota: Las guías deslizantes se pueden montar en cualquier nivel.

FUNCIONES



CONVENCIONAL

Para cocinar cualquier tipo de plato en un solo estante.



AIRE FORZADO

Para cocinar diferentes alimentos que requieren la misma temperatura de cocción en varios niveles (máximo tres) al mismo tiempo. Esta función puede utilizarse para cocinar diferentes alimentos sin que se mezclen los olores.



PIZZA

Para cocinar distintos tipos y formatos de pan y pizza. Es recomendable cambiar la posición de las bandejas pasteleras a medio proceso de cocción.



GRILL

Para asar al grill bistecs, kebabs y salchichas, cocinar verduras gratinadas o tostar pan.

Cuando ase carne, le recomendamos colocar la grasera debajo para recoger los jugos de cocción: Coloque el recipiente en cualquiera de los niveles debajo de la rejilla y añada 200 ml de agua potable.



TURBO GRILL

Para asar grandes piezas de carne (pierna de cordero, rosbif, pollo). Le recomendamos utilizar la grasera para recoger los jugos de cocción: coloque el recipiente en cualquiera de los niveles debajo de la rejilla y añada 200 ml de agua potable.



LEUDAR

Para hacer que las masas dulces o saladas fermenten bien. Para seleccionar esta función, gire el selector del termostato al icono.



ECO AIRE FORZADO

Para cocinar asados y carne rellena en un solo estante. Para evitar que los alimentos se resequen, el aire circula de manera suave e intermitente. Cuando se utiliza esta función ECO, la luz permanece apagada durante la cocción, pero se puede volver a encender pulsando .



LIMP. AUTOMÁTICA - LIMP.PIROLÍTICA

Para eliminar las salpicaduras de cocción, utilice un ciclo a muy alta temperatura (más de 400 °C).

steam

- PESCA
- CARNE
- PAN

Las funciones steam brindan excelentes resultados gracias a la adición de vapor a los ciclos de cocción. Cuando el horno esté frío, vierta agua potable en el fondo del horno y seleccione la función específica para su preparación. Las cantidades y temperaturas óptimas de agua para cada categoría de alimentos se detallan en la tabla de cocción correspondiente. **No se recomienda precalentar el horno antes de introducir alimentos.**

PRIMER USO

1. AJUSTE DE LA HORA

La primera vez que encienda el aparato, tendrá que ajustar la hora: Pulse hasta que el icono y los dos dígitos de la hora empezarán a parpadear en la pantalla.



Utilice o para ajustar la hora y pulse para confirmar. Los dos dígitos de los minutos empezarán a parpadear. Utilice o para ajustar los minutos y pulse para confirmar.

Nota: Cuando el icono parpadee, por ejemplo, después de un corte de suministro prolongado, tendrá que volver a configurar la hora.

2. CONFIGURACIÓN DEL CONSUMO DE POTENCIA

El horno está programado para trabajar con una potencia inferior a 2,9 kW ("Lo"): Para utilizar el horno con una potencia que sea compatible con una fuente de alimentación doméstica superior a 3 kW ("Hi"), deberá cambiar las configuraciones.

Para ir al menú de modificación, gire el selector hasta , y después vuelva a girarlo hasta 0.

Pulse y mantenga pulsado y durante cinco segundos inmediatamente después.



Utilice o para cambiar las configuraciones, luego pulse y mantenga pulsado durante al menos dos segundos para confirmar.

3. CALENTAR EL HORNO

Un horno nuevo puede liberar olores que se han quedado impregnados durante la fabricación: es completamente normal.

Antes de empezar a cocinar, le recomendamos calentar el horno en vacío para eliminar cualquier olor.

Quite todos los cartones de protección o el film transparente del horno y saque todos los accesorios de su interior.

Caliente el horno a 250 °C durante una hora aproximadamente. Durante este tiempo, el horno debe permanecer vacío.

Nota: Es aconsejable ventilar la habitación después de usar el aparato por primera vez.

USO DIARIO

1. SELECCIONAR UNA FUNCIÓN

Para seleccionar una función, gire el *selector* hasta el símbolo de la función deseada: la pantalla se iluminará y sonará una señal acústica.



2. ACTIVAR UNA FUNCIÓN

MANUAL

Para iniciar la función seleccionada, gire el *selector del termostato* hasta la temperatura deseada.



Nota: Durante la cocción puede cambiar la función girando el *selector* o regulando la temperatura con el *selector del termostato*. La función no se iniciará si el *selector del termostato* está a 0. Puede programar el tiempo de cocción, el tiempo de finalización de la cocción (solo si selecciona un tiempo de cocción) y un temporizador.

LEUDAR

Para activar la función «Fermentar masas», gire el *selector del termostato* al símbolo correspondiente; si el horno está programado con una temperatura diferente, la función no se activará.

Nota: Puede programar el tiempo de cocción, el tiempo de finalización de la cocción (solo si selecciona un tiempo de cocción) y un temporizador.

steam:

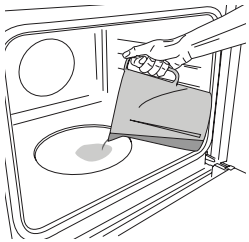

Cuando el horno esté frío, llene el relieve de la cavidad con la cantidad de agua potable sugerida en la tabla de cocción correspondiente. Introduzca el alimento.

Configure y active la función steam: . Al final, abra con cuidado la puerta y deje que el vapor escape lentamente.

Nota: Durante la cocción al vapor, no abra la puerta y nunca llene el agua.

3. PRECALENTAMIENTO

Una vez iniciada la función, una señal acústica y un icono parpadeando en la pantalla le indicarán que la fase de precalentamiento se ha activado.

Cuando el precalentamiento haya terminado, sonará una señal acústica y el icono fijo en la pantalla le indicará que el horno ha alcanzado la temperatura programada: coloque los alimentos dentro y proceda con la cocción.

Nota: Colocar los alimentos en el horno antes de que haya finalizado el precalentado puede tener efectos adversos en el resultado final de la cocción.

. COCCIÓN PROGRAMADA

Antes de comenzar la cocción, deberá seleccionar una función.

DURACIÓN

Mantenga pulsado hasta que el icono y «00:00» empiecen a parpadear en la pantalla.



Utilice o para configurar el tiempo de cocción deseado y después pulse para confirmar.

Active la función girando el *selector del termostato* hasta la temperatura deseada: Sonará una señal acústica y la pantalla indicará que la cocción ha terminado.

Nota: Para cancelar el tiempo de cocción programado, mantenga pulsado hasta que el icono empiece a parpadear en la pantalla y después use para reconfigurar el tiempo de cocción a «00:00». Este tiempo de cocción incluye una fase de precalentado.

SELECCIONAR LA HORA DE FINALIZACIÓN DE LA COCCIÓN/ INICIO DIFERIDO

Una vez programado el tiempo de cocción, se puede retrasar el inicio de la función programando su hora de finalización: pulse hasta que el icono y la hora actual parpadeen en la pantalla.



Utilice o para ajustar el tiempo deseado de finalización de cocción y pulse para confirmar.

Active la función girando el *selector del termostato* hasta la temperatura deseada: la función se iniciará automáticamente cuando haya transcurrido el periodo de tiempo calculado para que la cocción termine a la hora programada.

Nota: Para cancelar la programación, apague el horno girando el *selector* a la posición «0».

La función de inicio retardado no está disponible para las funciones Grill y Turbo Grill.

FINAL DE COCCIÓN

Sonará una señal acústica y la pantalla indicará que la función ha terminado.

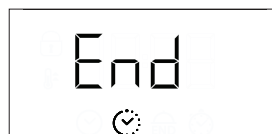



Gire el *selector* para seleccionar una función diferente o póngalo en 0 para apagar el horno.



Nota: Si el temporizador está activado, la pantalla mostrará la palabra «END» alternada con el tiempo restante.



. AJUSTE DEL TEMPORIZADOR

Esta opción no interrumpe ni programa la cocción, pero le permite utilizar la pantalla como temporizador, tanto si la función está activada como si el horno está apagado.

Mantenga pulsado  hasta que el icono  «00:00» y «00:00» empiecen a parpadear en la pantalla.



Utilice  o  para configurar la hora y pulse  para confirmar. Una vez que haya finalizado la cuenta atrás sonará una señal acústica.

Notas: Para cancelar el temporizador, mantenga pulsado  hasta que el icono  empiece a parpadear y después use  para reconfigurar el tiempo a «00:00».

. FUNCIÓN DE LIMPIEZA AUTOMÁTICA - LIMP. PIROLÍTICA

No toque el horno durante el ciclo de limpieza pirolítica.

Mantenga a los niños y a los animales alejados del horno durante y después (hasta que la habitación haya terminado de ventilarse) del ciclo de limpieza pirolítica.

Retire todos los accesorios del horno antes de activar esta función (incluidas las guías de los estantes). Si va a instalar el horno debajo de una encimera, asegúrese de que todos los quemadores o placas eléctricas estén apagados durante el ciclo de autolimpieza.

Para obtener los mejores resultados de limpieza, antes de utilizar la función de limpieza pirolítica, elimine la suciedad más importante con un paño húmedo.

Evite activar el ciclo de limpieza pirolítica en caso de que haya incrustaciones de cal.

Active la función Limp. Piro solamente si el horno está muy sucio o desprende mal olor durante la cocción.

























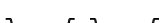



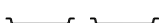

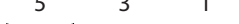



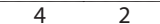

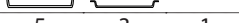







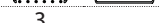













Para activar la función de limpieza automática, gire el *selector* y el *selector del termostato* hasta el icono .

La función se activará automáticamente, la puerta se bloqueará y la luz del horno se apagará: La pantalla mostrará el tiempo restante alternado con la palabra «Piro».



Una vez terminado el ciclo, la puerta permanece bloqueada hasta que la temperatura en el interior del horno haya vuelto a un nivel seguro. Ventile la habitación durante y después del ciclo de limpieza pirolítica.

TABLA DE COCCIÓN

RECETA	FUNCIÓN	PRECALENTAR	TEMPERATURA (°C)	DURACIÓN (MIN)	NIVEL Y ACCESORIOS
Tartas esponjosas		Sí	170	30 - 50	3 
		Sí	160	30 - 50	2 
		Sí	160	40 - 60	4 1 
Bizcocho relleno (tarta de queso, strudel, tarta de frutas)		Sí	160 - 200	35 - 90	2 
		Sí	160 - 200	40 - 90	4 2 
Biscuits / tartaletas		Sí	160	25 - 35	3 
		Sí	160	25 - 35	3 
		Sí	150	35 - 45	4 2 
Lionesas		Sí	180 - 210	30 - 40	3 
		Sí	180 - 200	35 - 45	4 2 
		Sí	180 - 200	35 - 45	5 3 1 
Merengues		Sí	90	150 - 200	3 
		Sí	90	140-200	4 2 
		Sí	90	140 - 200	5 3 1 
Pizza/Focaccia		Sí	190-250	15-50	1 / 2 
		Sí	190 - 250	20 - 50	4 2 
Pizza congelada		Sí	250	10 - 20	3 
		Sí	230-250	10 - 25	4 2 
Tartas saladas (tarta de verdura, quiche)		Sí	180 - 200	40 - 55	3 
		Sí	180 - 200	45 - 60	4 2 
		Sí	180 - 200	45 - 60	5 3 1 
Volovanes/hojaldres		Sí	190-200	20-30	3 
		Sí	180 - 190	20 - 40	4 2 
		Sí	180 - 190	20 - 40	5 3 1 
Lasaña / pasta al horno / canelones / budines		Sí	190 - 200	45-65	2 
Cordero / Ternera / Carne de res / Cerdo 1 kg		Sí	190 - 200	80-110	3 
Cerdo asado con piel 2 kg		Sí	180 - 190	110 - 150	3 
Pollo / Conejo / Pato 1 kg		Sí	200-230	50-100	2 
Pavo / Oca 3 kg		-	190 - 200	100-160	2 
Pescado al horno / en papillote (filetes, entero)		Sí	170 - 190	30 - 45	2 

FUNCIÓNES

 6Convencional

 Aire Forzado

 Pizza

 GRILL

 Turbo Grill

 Eco aire forzado

ACCESORIOS

 Rejilla

 Bandeja para hornear o molde sobre rejilla

 Bandeja pastelera / Grasera o bandeja para hornear sobre la rejilla

 Grasera / Bandeja pastelera

 Grasera/bandeja pastelera con 200 ml de agua

RECETA	FUNCIÓN	PRECALENTAR	TEMPERATURA (°C)	DURACIÓN (MIN)	NIVEL Y ACCESORIOS
Verduras rellenas (tomates, calabacines, berenjenas)		Sí	180 - 200	50 - 70	3
Pan tostado		5'	250	2 - 6	5
Filetes/rodajas de pescado		-	230 - 250	15 - 30 *	4 3
Salchichas / pinchos morunos / costillas / hamburguesas		-	250	15 - 30 *	5 4
Pollo asado 1-1,3 kg		Sí	200 - 220	55-70 **	2 1
Rosbif poco hecho 1 kg		Sí	200 - 210	35 - 50 **	3
Pierna de cordero / codillo		Sí	200 - 210	60-90 **	3
Patatas al horno		Sí	200 - 210	35 - 55	2
Verduras gratinadas		-	200 - 210	25-55	3
Carnes y patatas		Sí	190-200	45-100 ***	4 1
Pescados y verduras		Sí	180	30 - 50 ***	4 2
Lasañas y carnes		Sí	200	50-100 ***	4 1
Menú completo: Tarta de fruta (nivel 5)/lasaña (nivel 3)/carne (nivel 1)		Sí	180 - 190	40 - 120 ***	5 3 1
Carne asada / carne rellena asada		-	170 - 180	100-150	3

*Dar la vuelta al alimento a mitad de la cocción

** Darle la vuelta al alimento en el segundo tercio de la cocción (si fuera necesario).

*** Tiempo de cocción estimado: Los platos se pueden extraer del horno antes o después según los gustos personales.

steam

RECETA	FUNCIÓN	Agua (ml)	PRECALENTAR	TEMPERATURA (°C)	DURACIÓN (MIN)	NIVEL Y ACCESORIOS
Filetes de pescado / chuletas 0,5 - 2 cm	steam	250	-	190 - 210	15 - 25	3
Pescado entero 300 - 600 g	steam	250	-	190 - 210	15 - 30	3
Pescado entero 600 g - 1,2 kg	steam	250	-	180 - 200	25 - 45	3
Rosbif poco hecho 1 kg	steam	250	-	190 - 210	40 - 55	3
Pierna de cordero 500 g - 1,5 kg	steam	250	-	170 - 190	60 - 75	2
Pollo / pintada / pato Entero 1 - 1,5 kg	steam	250	-	200 - 220	55 - 75	2
Pollo, pintada y pato Piezas 500 g - 1,5 kg	steam	250	-	200 - 220	40 - 60	3
Pollo / pavo / pato Entero 3 kg	steam	250	-	160 - 180	100 - 140	2
Cordero / ternera / buey 1 kg	steam	250	-	170 - 190	60 - 100	3
Pan pequeño 80 - 100 g	steam	200	-	200 - 220	30 - 45	3
Pan de sándwich en lata 300 - 500 g	steam	250	-	170 - 190	45 - 60	3
Barra de pan 500 g - 2 kg	steam	250	-	160 - 170	50-100	2
Baguette 200 - 300 g	steam	250	-	200 - 220	30 - 45	3

El tiempo indicado incluye la fase de precalentamiento: recomendamos colocar los alimentos en el horno y ajustar el tiempo de cocción al iniciar la función.

FUNCIONES							steam	steam	steam
	6Convencional	Aire Forzado	Pizza	GRILL	Turbo Grill	Eco aire forzado	Pescado	CARNES	Pan
ACCESORIOS									
	Rejilla	Bandeja para hornear o molde sobre rejilla	Bandeja para hornear o bandeja para hornear sobre la rejilla	Bandeja pastelera / Grasera o bandeja para hornear sobre la rejilla	Grasera / Bandeja pastelera	Grasera/bandeja pastelera con 200 ml de agua			

LIMPIEZA Y MANTENIMIENTO

Asegúrese de que el horno se haya enfriado antes de llevar a cabo las tareas de mantenimiento o limpieza. No utilice aparatos de limpieza con vapor.

No utilice estropajos de acero, estropajos abrasivos ni productos de limpieza abrasivos/corrosivos, ya que podrían dañar las superficies del aparato. Utilice guantes de protección.

El horno debe desconectarse de la red eléctrica antes de llevar a cabo cualquier trabajo de mantenimiento.

SUPERFICIES EXTERIORES

Limpie las superficies con un paño húmedo de microfibra. Si están muy sucias, añada unas gotas de detergente neutro al agua. Seque con un paño seco. No utilice detergentes corrosivos ni abrasivos. Si uno de esos productos entra accidentalmente en contacto con la superficie del aparato, límpielo de inmediato con un paño húmedo de microfibra.

SUPERFICIES INTERIORES

• Después de cada uso, deje que el horno se enfríe y, a continuación, límpielo, preferiblemente cuando aún esté tibio, para quitar los restos o manchas causados por los residuos de los alimentos. Para secar la condensación que se haya podido formar debido a la cocción de alimentos con un alto contenido en agua, deje que el horno se enfríe por completo y límpielo con un paño o esponja.

• Para eliminar las incrustaciones de cal restantes del fondo de la cavidad después de la steam:coocción, basta con verter 250 ml de vinagre blanco en el relieve de la cavidad (o bien utilice un producto descalcificador específico).

Para consultar su disponibilidad, por favor contacte con el Servicio Postventa). Deje que funcione a temperatura ambiente durante 30 minutos. Luego limpie la cavidad con agua potable tibia y un paño suave. Se recomienda limpiar al menos cada 5 a 10 steam:coocción ciclos de cocción.

- Si hay suciedad persistente en las superficies interiores, se recomienda activar la función de limpieza automática para obtener los mejores resultados. Evite activar el ciclo de limpieza pirolítica en caso de que haya incrustaciones de cal. Antes de activarlo, limpie las incrustaciones de cal como se ha descrito anteriormente.
- La puerta se extrae fácilmente para facilitar la limpieza del cristal.
- Limpie el cristal de la puerta con un detergente líquido adecuado.

ACCESORIOS

Después del uso sumerja los accesorios en una solución líquida con detergente, utilice guantes si aún están calientes. Los residuos de alimentos pueden quitarse con un cepillo o esponja.

EXTRACCIÓN E INSTALACIÓN DE LA PUERTA

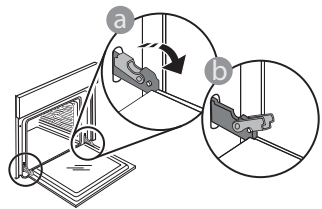

1. Para quitar la puerta, ábrala por completo y baje los pestillos hasta que estén en posición desbloqueada.

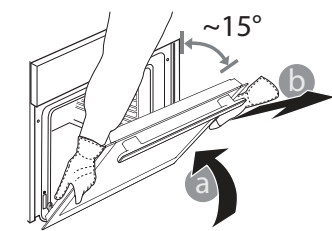

2. Cierre la puerta tanto como pueda. Sujete bien la puerta con las dos manos; no la sujete por el asa. Simplemente extraiga la puerta continuando cerrándola y a la vez levantándola hasta que se

salga de su alojamiento. Ponga la puerta en un lado, apoyada sobre una superficie blanda.

3. Vuelva a instalar la puerta llevándola hacia el horno, alineando los ganchos de las bisagras con sus alojamientos y fijando la parte superior en su alojamiento.

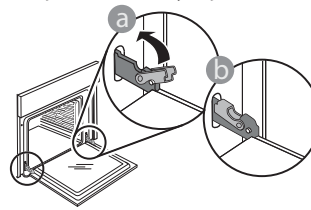

4. Baje la puerta y ábrala por completo. Baje los pestillos a su posición original: Asegúrese de haberlos bajado por completo.

Presione suavemente para comprobar que los pestillos están en la posición correcta.

5. Intente cerrar la puerta y compruebe que esté alineada con el panel de control. Si no lo está, repita los pasos de arriba: La puerta podría dañarse si no funciona correctamente.

SUSTITUCIÓN DE LA LÁMPARA

1. Desconecte el horno de la red eléctrica.
2. Desenrosque la tapa de la lámpara, sustituya la bombilla y vuelva a enroscar la tapa de la lámpara.
3. Vuelva a conectar el horno a la red eléctrica.

Nota: Utilice bombillas halógenas de 25 W/230 V tipo G9, T 300 °C. La bombilla que se usa en el aparato está diseñada específicamente para electrodomésticos y no es adecuada para la iluminación general de estancias de una vivienda (Normativa CE 244/2009).

Las bombillas están disponibles en nuestro Servicio Postventa. - No manipule las bombillas con las manos desprotegidas, ya

que las huellas dactilares podrían dañarlas. No utilice el horno hasta que no haya vuelto a colocar la tapa de la bombilla.

HAGA CLIC PARA LIMPIAR - LIMPIEZA DE LOS CRISTALES

1. Después de desmontar la puerta y colocarla sobre una superficie blanda con las asas hacia abajo, pulse simultáneamente los dos enganches de retención y extraiga la parte superior de la puerta tirando hacia usted.

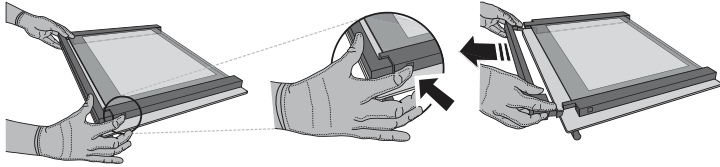

2. Sujete los cristales interiores firmemente con las dos manos, extráigalos y colóquelos sobre una superficie blanda antes de limpiarlos.

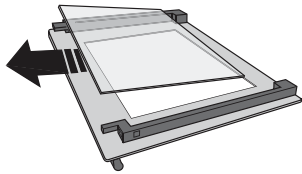

3. Vuelva a colocar la hoja intermedia (marcada con «1R»)

antes de volver a colocar la hoja interna: Para colocar las hojas de cristal correctamente, asegúrese de que la marca “R” se vea en la esquina de la izquierda. Primero introduzca el lado largo del cristal marcado con una «R» en los soportes y después bájelo hasta su posición. Repita este procedimiento en ambas hojas de cristal.

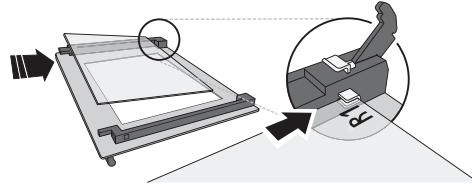

4. Vuelva a colocar la parte superior: un clic le indicará que se ha colocado correctamente. Asegúrese de que el precinto esté asegurado antes de volver a montar la puerta.

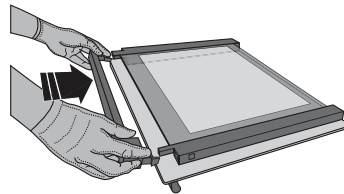

RESOLUCIÓN DE PROBLEMAS

PROBLEMA	POSIBLE CAUSA	SOLUCIÓN
El horno no funciona.	Corte de suministro. Desconexión de la red eléctrica.	Compruebe que haya corriente eléctrica en la red y que el horno esté enchufado a la toma de electricidad. Apague el horno y vuelva a encenderlo para comprobar si se ha solucionado el problema.
En la pantalla aparecerá la letra «F» seguida de un número o letra.	Fallo del horno.	Póngase en contacto con el Servicio Postventa más cercano e indique el número que aparece detrás de la letra «F».
La pantalla muestra el mensaje «Hot» y la función seleccionada no se inicia.	Temperatura demasiado alta.	Deje que el horno se enfríe antes de activar la función. Seleccione otra función.



Puede consultar los reglamentos, la documentación estándar y información adicional sobre productos mediante alguna de las siguientes formas:

- Visitando nuestra página web docs.hotpoint.eu
- Usando el código QR
- También puede **ponerse en contacto con nuestro Servicio postventa** (Consulte el número de teléfono en el folleto de la garantía). Cuando se ponga en contacto con nuestro Servicio Postventa, deberá indicar los códigos que figuran en la placa de características de su producto.

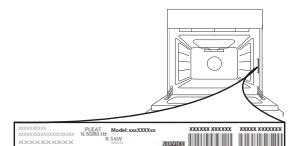



400020006263