



 **ARISTON**



www.aristonchannel.com



SAFETY INSTRUCTIONS

IMPORTANT TO BE READ AND OBSERVED

Before using the appliance read these safety instructions. Keep them nearby for future reference.

These instructions are valid if the country symbol appears on the appliance. If the symbol doesn't appear on the appliance, it is necessary to refer to the technical instructions which will provide the necessary instructions concerning modification of the appliance to the conditions of use of the country.

CAUTION: The use of the gas cooking appliance results in the production of heat, moisture and products of combustion in the room in which it is installed. Ensure that the kitchen is well ventilated especially when the appliance is in use: keep natural ventilation holes open or install a mechanical ventilation device (mechanical extractor hood). Prolonged intensive use of the appliance may call for additional ventilation, for example opening of the window, or more effective ventilation, increasing the level of mechanical ventilation where present.

These instructions and the appliance itself provide important safety warnings, to be observed at all times.

The manufacturer declines any liability for failure to observe these safety instructions, for inappropriate use of the appliance or incorrect setting of controls.

If the information in this manual is not followed exactly, a fire or explosion, may result causing property damage or injury.

SAFETY WARNINGS

Very young (0-3 years) and young children (3-8 years) shall be kept away from the appliance unless continuously supervised.

Children from 8 years old and above and persons with reduced physical, sensory or mental capabilities or lack of experience and knowledge can use this appliance only if they are supervised or have been given instructions on safe use and understand the hazards involved. Children must not play with the appliance. Cleaning and user maintenance must not be carried out by children without supervision.

WARNING: The appliance and its accessible parts become hot during use, children less than 8 year of age shall be kept away unless continuously supervised.

WARNING: Avoid touching heating elements or interior surface - risk of burns. Never leave the appliance unattended during food drying. If the appliance is suitable for probe usage, only use the temperature probe recommended for this oven. Keep clothes or other flammable materials away from the appliance, until all the components have cooled down completely.

Overheated oils and fats catch fire easily. Always be vigilant when cooking food rich in fat, oil or when adding alcohol (e.g. rum, cognac, wine) - risk of fire. Use oven gloves to remove pans and accessories, taking care not to touch the heating elements. At the end of cooking, exercise caution when opening the door, by letting the hot air or steam exit gradually before accessing the appliance.

Do not obstruct hot air vents at the front of the oven.

PERMITTED USE

CAUTION: The appliance is not intended to be operated by means of an external timer or separate remote controlled system.

This appliance is solely for domestic, not professional use. Do not use the appliance outdoors.

Do not store explosive or flammable substances such as aerosol cans and do not place or use gasoline or other flammable materials in or near the appliance: a fire may break out if the appliance is inadvertently switched on.

No other use is permitted (e.g. heating rooms).

INSTALLATION

The appliance must be handled and installed by two or more persons. Use protective gloves to unpack and install the appliance.

The electrical and gas connections must comply with local regulation.

WARNING: Modification of the appliance and its method of installation are essential in order to use the appliance safely and correctly in all the additional countries.

Use pressure regulators suitable for the gas pressure indicated in the instruction.

Connection with rigid pipe (copper or steel).

If the gas pressure is different from the recommended pressure, a suitable pressure regulator must be fitted to the inlet pipe in accordance with the current National Regulations. The room must be equipped with an air extraction system that expels any combustion fumes. This may consist of a hood or an electric fan that automatically starts each time the appliance is switched on.

The room must also allow proper air circulation, as air is needed for combustion to occur normally. The flow of air must not be less than 2 m³/h per kW of installed power.

The air circulation system may

take air directly from the outside by means of a pipe with an inner cross section of at least 100 cm²; the opening must not be vulnerable to any type of blockages.

The system can also provide the air needed for combustion indirectly, i.e. from adjacent rooms fitted with air circulation tubes as described above.

However, these rooms must not be communal rooms, bedrooms or rooms that may present a fire hazard.

Liquid petroleum gas sinks to the floor as it is heavier than air. Therefore, rooms containing LPG cylinders must also be equipped with vents to allow gas to escape in the event of a leak. As a result LPG cylinders, whether partially or completely full, must not be installed or stored in rooms or storage areas that are below ground level (cellars, etc.). It is advisable to keep only the cylinder being used in the room, positioned so that it is not subject to heat produced by external sources (ovens, fireplaces, stoves, etc.) which could raise the temperature of the cylinder above 50°C.

Use an appropriate cabinet to ensure that the appliance operates properly: to install the oven under the counter (see diagram) or in a kitchen unit, the cabinet must have the dimensions as the picture.

To ensure adequate ventilation, the back panel of the cabinet must be removed. It is advisable to install the oven so that it rests on two strips of wood, or on a completely flat surface with an opening of at least 45 x 560 mm as the picture.

GAS CONNECTION

WARNING: Prior to installation, ensure that the local distribution conditions (nature of gas and gas pressure) and the adjustment of the appliance are compatible.

Check that the pressure of the gas supply is consistent with the values indicated in Table 1 ("Burner and nozzle specifications").

WARNING: The adjustment conditions for this appliance are stated on the label (or data plate).

WARNING: This appliance is not connected to a combustion products evacuation device. It shall be installed and connected in accordance with current installation regulations.

Particular attention shall be given to the relevant requirements regarding ventilation.

If the appliance is connected to liquid gas, the regulation screw must be fastened as tightly as possible.

IMPORTANT: When gas cylinder is adopted, the gas cylinder or gas container must be properly settled (vertical orientation).

WARNING: This operation must be performed by a qualified technician.

Use only flexible or rigid metal hose for gas connection.

Connection with a rigid pipe (copper or steel)

Connection to the gas system must be carried out in such a way as not to place any strain of any kind on the appliance.

There is an adjustable L-shaped pipe fitting on the appliance supply ramp and this is fitted with a seal in order to prevent leaks. The seal must always be replaced after rotating the pipe fitting (the seal is provided with the appliance).

The gas supply pipe fitting is a threaded 1/2 gas cylindrical male attachment.

Connecting a flexible jointless stainless steel pipe to a threaded attachment

The gas supply pipe fitting is a threaded 1/2 gas cylindrical male attachment. These pipes must be installed so that they are never longer than 2000 mm when fully extended. Once connection has been carried

out, make sure that the flexible metal pipe does not touch any moving parts and is not compressed.

Only use pipes and seals that comply with current National regulations.

IMPORTANT: If a stainless steel hose is used, it must be installed so as not to touch any mobile part of the furniture (e.g. drawer). It must pass through an area where there are no obstructions and where it is possible to inspect it on all its length.

The appliance should be connected to the main gas supply or to gas cylinder in compliance with the current National regulations. Before carry out the connection, make sure that the appliance is compatible with the gas supply you wish to use. If this is not the case, follow the instructions indicated in the paragraph "Adapting to different types of gas".

After connection to the gas supply, check for leaks with soapy water. Light up the burners and turn the knobs from max position to minimum position to check flame stability.

REPLACING THE INJECTORS

For the Oven, lower side
Remove the burner cover plate.

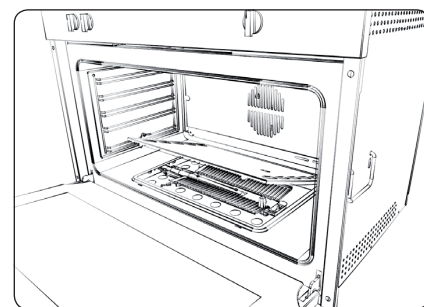

Remove the screw securing the oven burner and withdraw the burner from the support together with the heat sensor and the ignition spark plug.

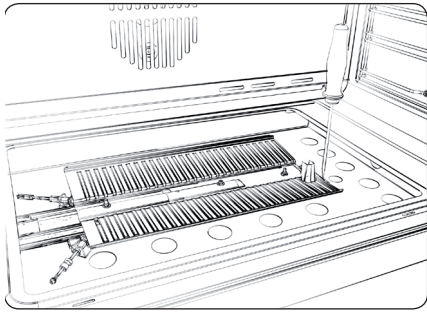

Remove the nozzle using a 7 mm socket wrench.

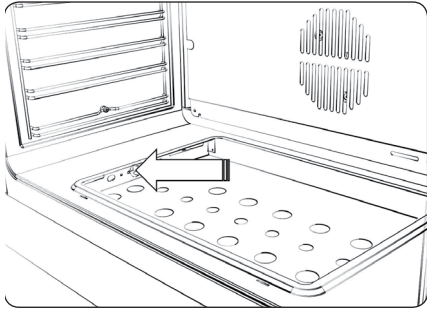

Screw the new injector in fully (diameter in hundredths of millimetre stamped on the injector), taking care not to cross the thread.
 Replace the burner reversing the operations in step 2 above.
 Replace the cover plate.
 Adjusting the minimum flame.
 Before installing the oven, remember to affix the gas calibration plate supplied with the injectors in such a way that it covers the existing information relating to gas calibration.

For the Grill, upper side (only in some models)

Remove the burner screw located at top front of the oven cavity.

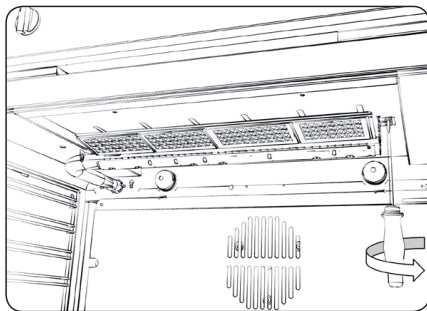

Remove the burner together with its heat elements.

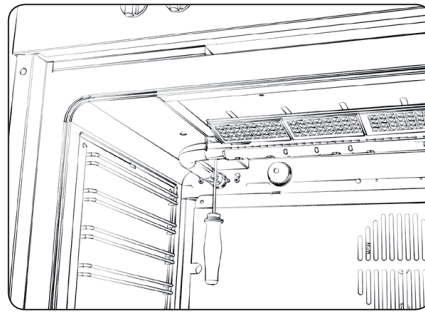

Remove the injector using the 7 mm socket wrench.

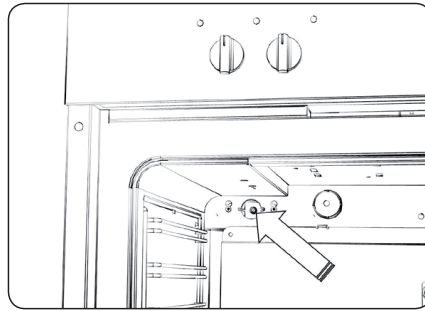

Fully tighten the new injector which must be of the diameter indicated in the table in the chart table.
 Put back the burner and secure it with the screw.
 Installation and repairs must be carried out by a qualified technician, in compliance with the manufacturer's instructions and local safety regulations. Do not repair or replace any part of the appliance unless specifically stated in the user manual.
 Children should not perform installation operations. Keep children away during installation. Keep the packaging materials (plastic bags, polystyrene parts, etc.) out of reach of children, during and after the installation.
 After unpacking the appliance, make sure that it has not been damaged during transport. In the event of problems, contact the dealer or your nearest After-sales Service.
 The appliance must be disconnected from the power supply before any installation operation.
 During installation, make sure the appliance does not damage the power cable.
 Only activate the appliance

when the installation has been completed.
 After installation, the bottom of the appliance must no longer be accessible.
 Carry out all cabinet cutting works before fitting the appliance in the furniture and carefully remove all wood chips and sawdust.
 Do not obstruct the minimum gap between the worktop and the upper edge of the oven.
 Only remove the oven from its polystyrene foam base at the time of installation.
 Do not install the appliance behind a decorative door - Risk of fire.

ELECTRICAL WARNINGS

For installation to comply with current safety regulations, an omnipolar switch with minimum contact gap of 3 mm is required and the appliance must be earthed.
 If the power cable is damaged, replace with an identical one. The power cable must only be replaced by a qualified technician in compliance with the manufacturer instruction and current safety regulations. Contact an authorized service center.
 It must be possible to disconnect the appliance from the power supply by unplugging it if plug is accessible, or by means of an accessible multi-pole switch installed upstream of the socket in conformity with national electrical safety standards.
 The rating plate is on the front edge of the oven (visible when the door is open).
 In case of replacement of power cable, contact an authorized service center.
IMPORTANT: The data relevant to the voltage and power absorptions are indicated on the rating plate
 If the fitted plug is not suitable for your socket outlet, contact a qualified technician.

The power cable must be long enough to connect the appliance, once fitted in its housing, to the main power supply. Do not pull the power supply cable.

Do not use extension leads, multiple sockets or adapters. Do not operate this appliance if it has a damaged mains cord or plug, if it is not working properly, or if it has been damaged or dropped. Keep the cord away from hot surfaces.

The electrical components must not be accessible to the user after installation.

Do not touch the appliance with any wet part of the body and do not operate it when barefoot.

The power cable must be long enough to connect the appliance, once fitted in its housing, to the main power supply. Do not pull the power supply cable.

The earthing of this appliance is compulsory by law.

The cable must be checked regularly and replaced by authorised technicians in compliance with the manufacturer instruction and current safety regulations.

CORRECT USE

Should you experience difficulty in turning the burners knobs, please contact After Sales Service for replacement of the burner tap if found to be faulty. The openings use for the ventilation and dispersion of heat must never be covered. When you place the rack inside, make sure that the stop is directed upwards and in the back of the cavity.

CLEANING AND MAINTENANCE

Never use steam cleaning equipment or pressure cleaners on the appliance.

WARNING: Ensure that the appliance is switched off before

replacing the lamp to avoid the possibility of electric shock. Do not use harsh abrasive cleaners or sharp metal scrapers to clean the appliance door glass since they can scratch the surface, which may result in shattering of the glass.

Wear protective gloves for cleaning and maintenance. The appliance must be disconnected from the power supply before any maintenance operation.

Ensure the appliance is cooled down before carrying out any cleaning or maintenance operation.

To avoid damaging the electric ignition device, do not use it when the burners are not in their housing.

Never use steam cleaning equipment or pressure cleaners on the appliance.

Wear protective gloves for cleaning and maintenance.

INJECTOR TABLE

	Burner	Type of gas	Gas Pressure mbar		Rated thermal flow rate kW	Rated Consumption	Injector marking
			nom	min/max			
GB	Oven	G20	20	17/25	3.4	324 l/h	130
		G30/G31	28-30/37	25/45	3.4	247 g/h	88
IE	Grill	G20	20	17/25	2.8	267 l/h	118
		G30/G31	28-30/37	25/45	2.8	204 g/h	83

SAFEGUARDING THE ENVIRONMENT

DISPOSAL OF PACKAGING MATERIALS

The packaging material is 100% recyclable and is marked with the recycle symbol . The various parts of the packaging must therefore be disposed of responsibly and in full compliance with local authority regulations governing waste disposal.

.....

SCRAPPING OF HOUSEHOLD APPLIANCES

When scrapping the appliance, make it unusable by cutting off the power cable and removing the doors and shelves (if present) so that children cannot easily climb inside and become trapped.

This appliance is manufactured with recyclable  or reusable materials. Dispose of it in accordance with local waste disposal regulations.

For further information on the treatment, recovery and recycling of household electrical appliances, contact your competent local authority, the collection service for household waste or the store where you purchase the appliance.

This appliance is marked in compliance with European Directive 2012/19/EU, Waste Electrical and Electronic Equipment (WEEE).

By ensuring this product is disposed of correctly, you will help prevent potential negative consequences for the environment and human health, which could otherwise be caused by inappropriate waste handling of this product.

The symbol  on the product or on the accompanying documentation indicates that it should not be treated as domestic waste but must be taken to an appropriate collection center for the recycling of electrical and electronic equipment.

ENERGY SAVING TIPS

Only preheat the oven if specified in the cooking table or your recipe. Use dark lacquered or enamelled baking moduls as they absorb heat far better.

DECLARATION OF CONFORMITY

This appliance has been designed, constructed and distributed in compliance with the requirements of European Directives: GAS 2009/142/EC.

This appliance, which is intended to come into contact with foodstuffs, complies with European Regulation **CE** n. 1935/2004.

This appliance meets the Eco Design requirements of European Regulations n. 65/2014, and n. 66/2014 in conformity to the European standard EN 60350-1.

PRODUCT DESCRIPTION

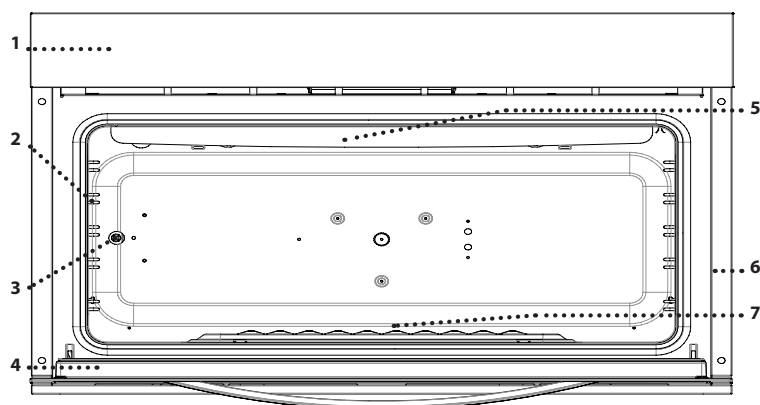

1. Control panel
2. Shelf guides
(the level is indicated on the wall of the cooking compartment)
3. Recess for turnspit
(if present)
4. Door
5. Upper heating element/grill
6. Identification plate
(do not remove)
7. Burner
(not visible)

CONTROL PANEL

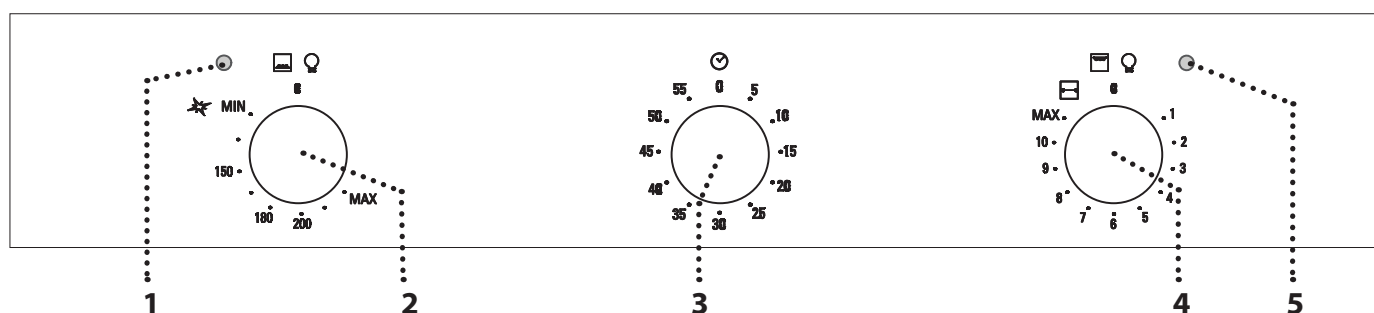

1. Gas oven indicator light
2. Thermostat knob
3. Minute minder
4. Grill, turnspit and ovenlight knob
5. Grill indicator light

ACCESSORIES

The number and type of accessories may vary depending on which model is purchased. Other accessories that are not supplied can be purchased separately from the After-sales Service.

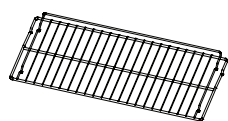

WIRE SHELF

The wire shelf can be used to grill food or as a support for pans, cake tins and other oven-proof cooking receptacles.

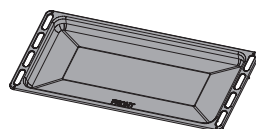

DRIP TRAY *

Designed to collect fat and food particles when it is positioned under the grid or as a plate, such as when cooking meat, chicken

and fish with or without vegetables. Pour a little of drinking water into the drip tray to prevent spatters of fat or oil and smoke.

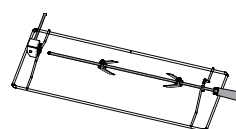

TURNSPIT. * For grilling poultry and roasts.

* Available only on certain models

INSERTING WIRE SHELVES AND OTHER ACCESSORIES

Insert the wire shelf onto the level you require by holding it tilted slightly upwards and resting the raised rear side (pointing upwards) down first. Then slide it horizontally along the runners as far as possible. The other accessories, such as the baking tray, are inserted horizontally by sliding them along the runners.

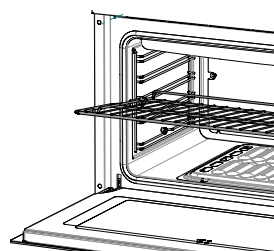

REMOVE THE LATERAL GRILLES

To remove the side grilles, press down the grilles and lift them up as shown. Then, extract the grilles from their seats.

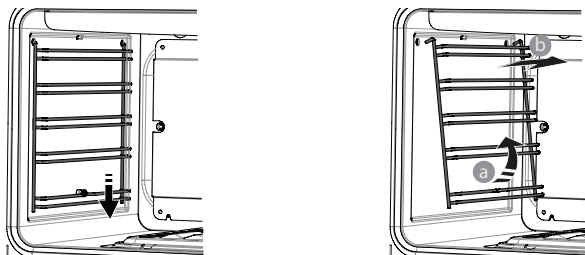

To refit the grilles, insert the top support, then slide them to be fitted close to the cavity and push them up to fix in their original position.

BEFORE USE

HEAT THE OVEN

A new oven may release odours that have been left behind during manufacturing: this is completely normal. Before starting to cook food, we therefore recommend heating the oven with it empty in order to remove any possible odours. Remove any protective cardboard or transparent film from the oven and remove any accessories from inside it. Heat the oven to the maximum temperature for about 20 minutes.

The oven must be empty during this time. Follow the instructions for setting the function correctly.

Please note: It is advisable to air the room after using the appliance for the first time.

DAILY USE

START THE GAS OVEN

Gently press the thermostat knob and turn it anti-clockwise to the **MAX** position: To light the burner hold the knob pressed in for 5-10 seconds. After that, turn the thermostat knob to the desired temperature (The **MIN** position corresponds to an oven temperature of 130° C, the **MAX** to an oven temperature of 250° C).

The thermostat knob must not be pressed and held for more than 15 seconds.

When the oven is in operation the gas oven indicator light switches on. To interrupt the cooking at any time, switching the oven off, turn the thermostat knob to the **0** position.

If the oven fails to switch on or it switches off accidentally, turn the thermostat knob back to the **0 position, open the oven door and wait at least one minute before attempting to switch the oven on again.**

USING THE ELECTRIC GRILL

Use the grill for grilling or browning foods. The heat intensity of the grill can be set from 1 to **MAX** using the relative control knob. When the grill is in operation, the grill indicator light and the oven interior light will be switched on.

While using the wire shelf, always place the tray with some drinking water under the food.

It is suggested to turn over the food about halfway through the cooking.

Please note: The grill will not operate when the oven gas is on.

USING THE TURNSPIT (if present)



Some ovens may be equipped with an electric motor, spit and skewers for roasting poultry or meat. Skewer the meat and secure it in place using the two forks. Put turnspit rod into the drive unit (A) and the groove into the bend (B).

Turn the plastic handle (C) anticlockwise. Slide the shelf into the oven runners ensuring that the rod slots into hole.

The turnspit shelf must always be fitted in the middle of the oven (second position from bottom).

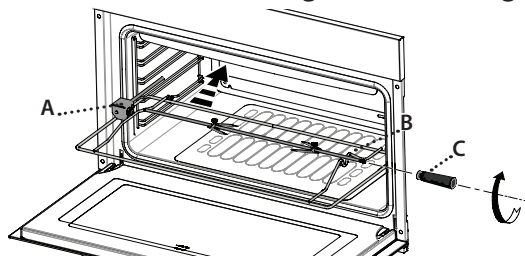
Place the tray to collect the cooking juices: Position it on the bottom level, adding some drinking water.



To operate the turnspit, turn the relative knob to the  icon: You will feel a "click". After that, turn the knob to the desired grill power position as indicated in paragraph above. To switch off the turnspit turn back the relative knob to the  icon, then turn it to the **0** position. We suggest to preheat the oven for 5 minutes. At the end of cooking take the turnspit out of the oven only by using its handle and oven gloves.

OVEN LIGHT





















Turn the knob to  to switch on the oven light. At the same time, will be activated also the turnspit (if present).





SET THE MINUTE MINDER

The Minute minder can be set to a maximum time of 60 minutes. The timer operates independently of the oven: it does not activate any function and won't stop it.

To activate the timer, turn the knob clockwise to the 60 minute position and then turned anti-clockwise to the desired time setting. When the set time has elapsed, the alarm will sound. The alarm tone will stop automatically after a certain period.

COOKING TABLE

RECIPE	FUNCTION	PREHEAT	TEMPERATURE (°C) / GRILL POWER	DURATION (MIN)	LEVEL AND ACCESSORIES
Swiss roll	-	Yes	210	15 - 20	4 
Short pastry	-	Yes	200	10 - 12	3 
Dough with rising agent	-	Yes	200	25 - 30	3 
Sponge cake	-	Yes	190	20 - 25	3 
Leavened dough	-	Yes	180	40 - 50	3 
Puff pastry	-	Yes	190	20 - 30	2 
Soufflè	-	Yes	180	35 - 40	2 
Sacher torte	-	Yes	180	55 - 60	2 
Fruit pie	-	Yes	160	160 - 180	2 
Choux pastry	-	Yes	200	35 - 40	2 
Roast beef	-	Yes	200	90 - 120	2 
Pizza	-	Yes	200	20 - 25	2 
Baked fish	-	Yes	200	50 - 60	4 
Baked vegetables	-	Yes	170	30 - 40	3 
Poultry	-	Yes	190 - 200	60 - 70	4 
Steaks		-	10	10 - 15	4 3  
Coutlet		-	10	15 - 25	4 3  

ACCESSORIES	 Wire shelf	 Baking dish or cake tin on the wire shelf	 Tray	 Tray with 200 ml of water
-------------	--	---	--	---

MAINTENANCE AND CLEANING

Make sure that the oven has cooled down before carrying out any maintenance or cleaning.

Do not use steam cleaners.

Do not use wire wool, abrasive scourers or abrasive/corrosive cleaning agents, as these could damage the surfaces of the appliance.

Wear protective gloves.

The oven must be disconnected from the mains before carrying out any kind of maintenance work.

EXTERIOR SURFACES

Clean surfaces with a damp microfibre cloth. If they are very dirty, add a few drops of pH-neutral detergent. Finish off with a dry cloth. Do not use corrosive or abrasive detergents. If any of these products inadvertently comes into contact with the surfaces of the appliance, clean immediately with a damp microfibre cloth.

INTERIOR SURFACES

After every use, leave the oven to cool and then clean it, preferably while it is still warm, to remove any deposits or stains caused by food residues. To dry any condensation that has formed as a result of cooking foods with a high water content, leave the oven to cool completely and then wipe it with a cloth or sponge. Clean the glass in the door with a suitable liquid detergent.

ACCESSORIES

Soak the accessories in a washing-up liquid solution after use, handling them with oven gloves if they are still hot.

Food residues can be removed using a washing-up brush or a sponge.

REMOVING AND REFITTING THE DOOR

To remove the door, open it fully and lift the catches, pushing them forwards until they are in the unlock position (1). Close the door as much as you can. Take a firm hold of the door with both hands – do not hold it by the handle. Simply remove the door by continuing to close it while pulling it upwards at the same time until it is released from its seating (2). Put the door to one side, resting it on a soft surface.

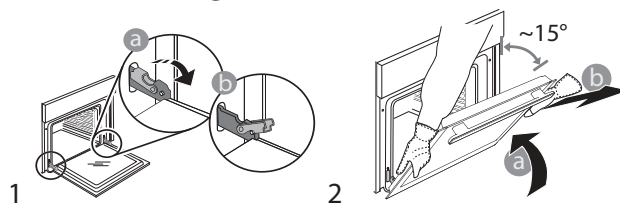

Refit the door by moving it towards the oven, aligning the hooks of the hinges with their seating and securing the upper part onto its seating. Lower the door and then open it fully. Lower the catches into their original position (3): Make sure that you lower them down completely. Apply gentle pressure to check that the catches are in the correct position.

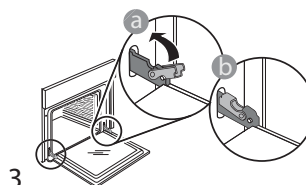

Try closing the door and check to make sure that it lines up with the control panel. If it does not, repeat the steps above: The door could become damaged if it does not work properly.

REPLACING THE LAMP

Disconnect the oven from the power supply, unscrew the cover from the light, replace the bulb and screw the cover back on the light. Reconnect the oven to the power supply.

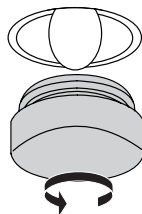

Please note: Only use 20-40 W/230 V type G9, T300 °C halogen bulbs. The bulb used in the product is specifically designed for domestic appliances and is not suitable for general room lighting within the home (EC Regulation 244/2009). Light bulbs are available from our After-sales Service. If using halogen bulbs, do not handle them with your bare hands as your fingerprints could cause damage. Do not use the oven until the light cover has been refitted.

TROUBLESHOOTING

Problem	Possible cause	Solution
The oven or the burner will not switch on.	Power cut. Disconnection from the mains electricity.	Check for the presence of mains electrical power and whether the oven is connected to the electricity supply. Wait at least one minute, then try to switch the oven on again and see if the problem persists.
	Gas supply interrupted.	Check that the gas tap upstream of the oven is open or that the liquid gas cylinder (if being used) is not empty.
	Switch-on procedure carried out incorrectly.	Wait at least one minute and then repeat the steps described in the "Daily use" section.
<p>In the event of problems, turn the adjustment knob back to the 0 position and open the oven door.</p>		

AFTER SALES SERVICE

Before calling the After-Sales Service:

See if you can solve the problem yourself with the help of the suggestions given in the "Troubleshooting".

If after the above checks the fault still occurs, get in touch with the nearest After-sales Service.

Always specify:

- a brief description of the fault;
- the type and exact model of the oven;
- the service number (number after the word Service on the rating plate), located on the right hand edge of the oven cavity (visible when the oven door is open).

The service number is also indicated on the guarantee booklet;

- your full address;
- your telephone number.

If any repairs are required, please contact an authorised After-sales Service (to guarantee that original spare parts will be used and repairs carried out correctly).

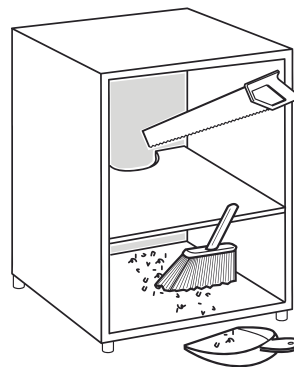
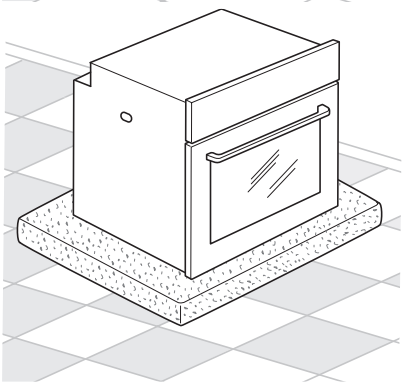
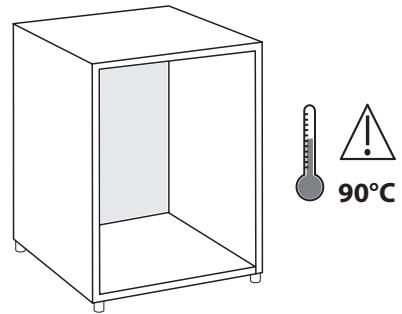
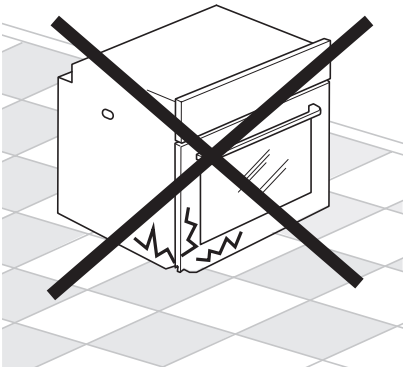
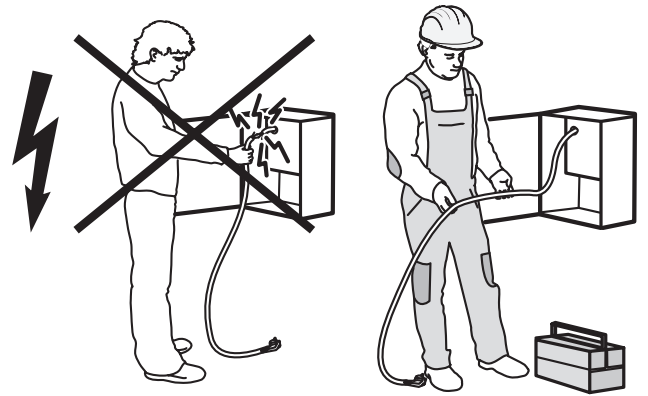
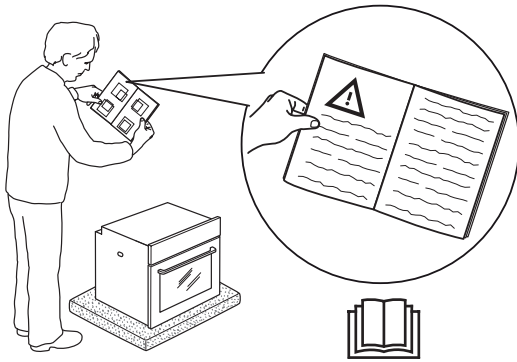
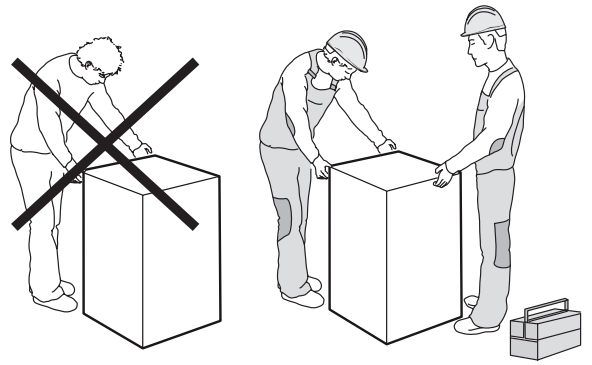
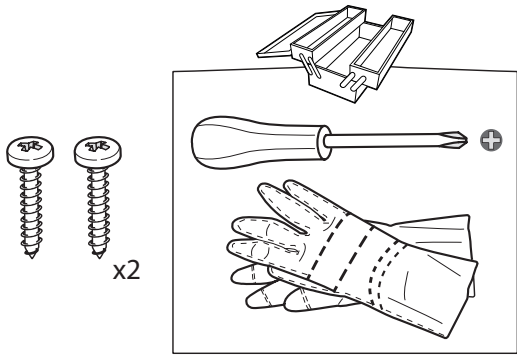

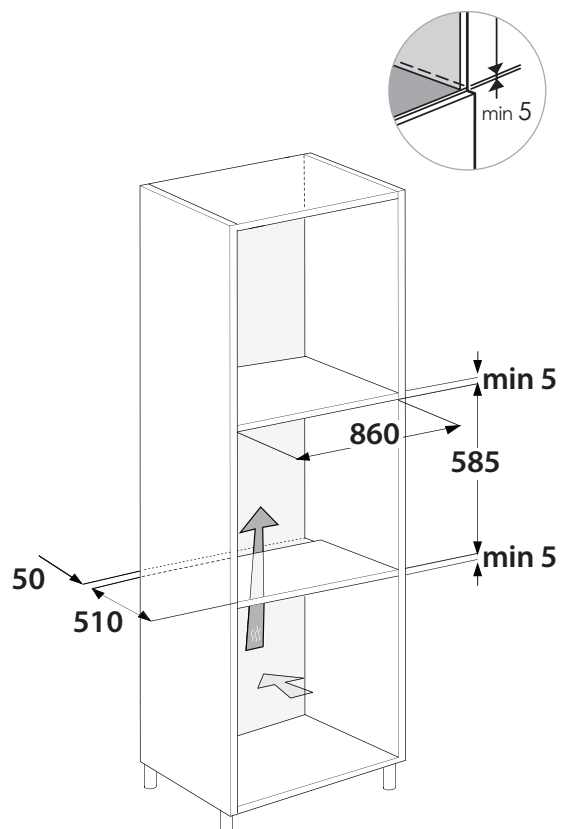
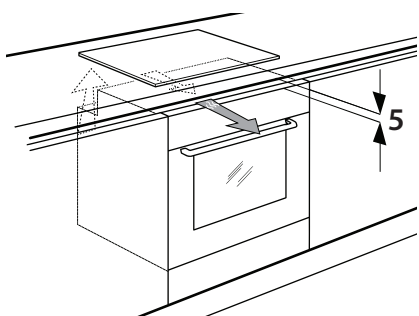
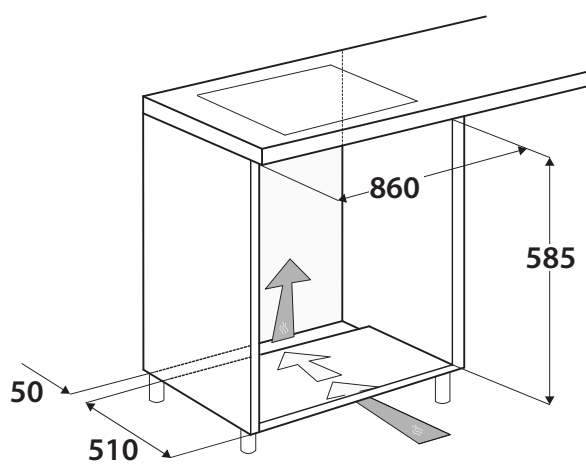
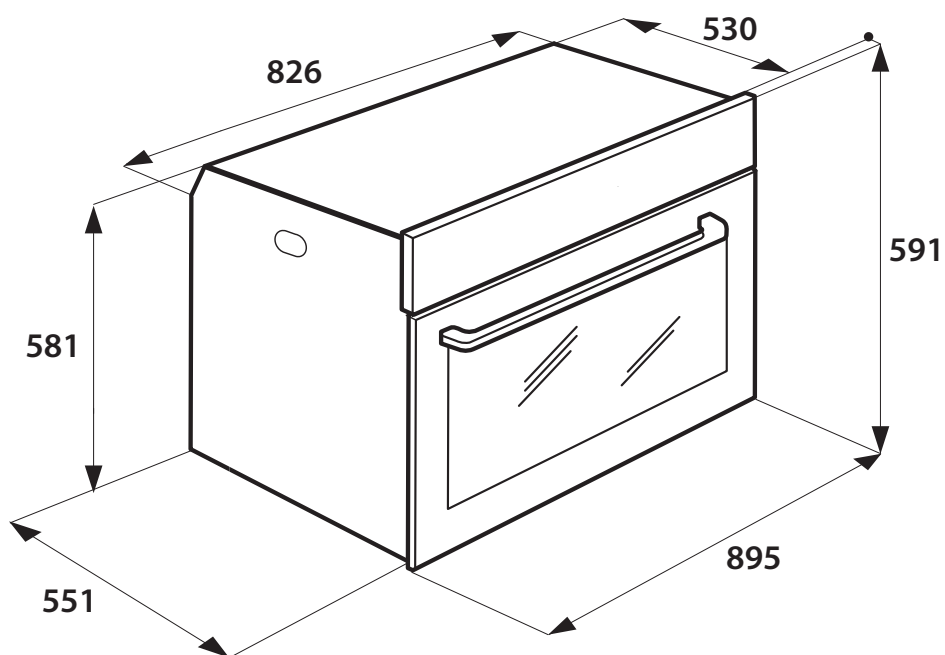

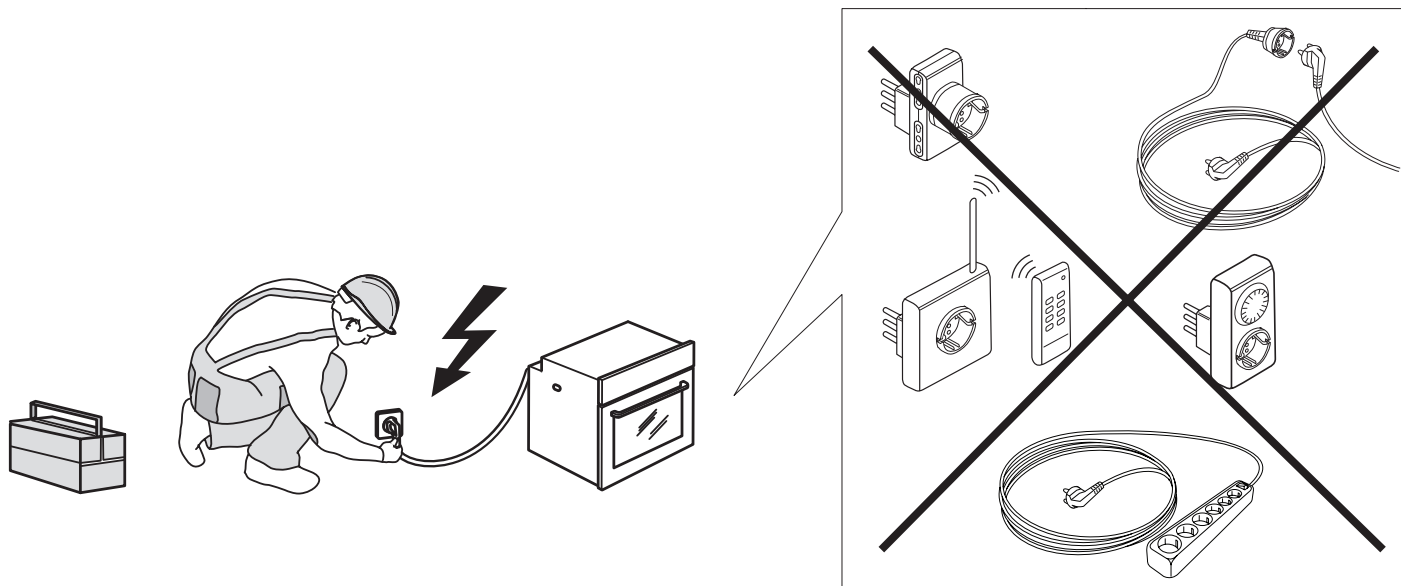
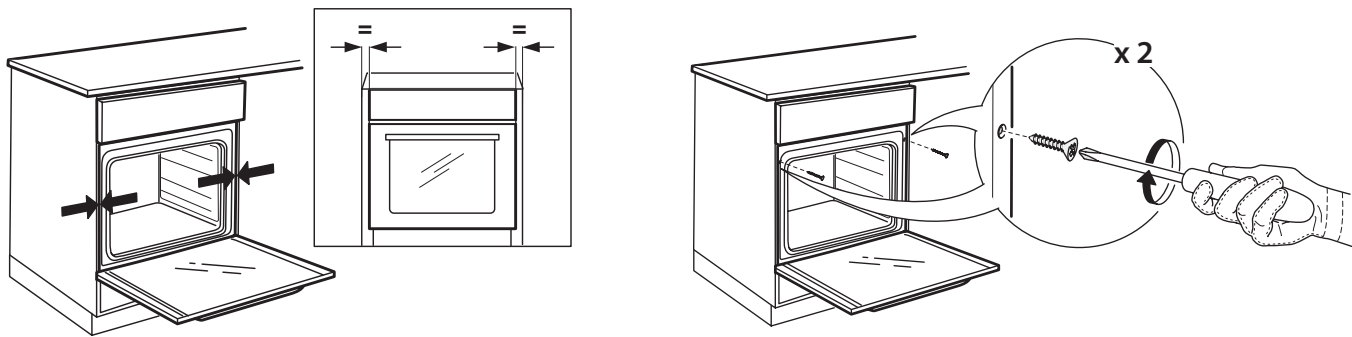
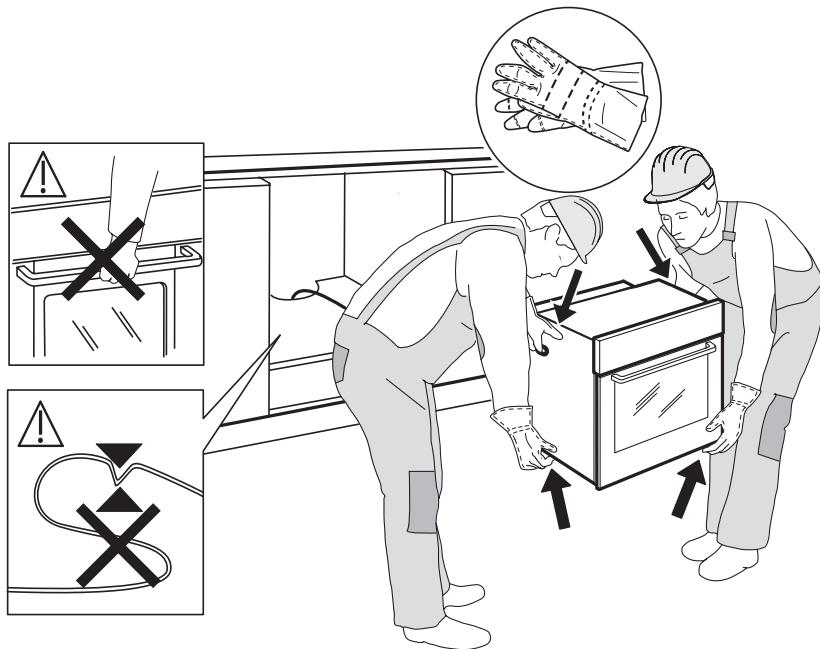

Manufacturer:
WHIRLPOOL EMEA S.P.A.
VIA CARLO PISACANE N.1,
20016 PERO (MI), ITALY



400011120650

Printed in Italy