

# **Instructions for Installation and Use**

**Built-under double oven**



# SAFETY INSTRUCTIONS

Before using the appliance, read these safety instructions. Keep them nearby for future reference.

These instructions and the appliance itself provide important safety warnings, to be observed at all times. The manufacturer declines any liability for failure to observe these safety instructions, for inappropriate use of the appliance or incorrect setting of controls.

⚠ Very young children (0-3 years) should be kept away from the appliance. Young children (3-8 years) should be kept away from the appliance unless continuously supervised. Children from 8 years old and above and persons with reduced physical, sensory or mental capabilities or lack of experience and knowledge can use this appliance only if they are supervised or have been given instructions on safe use and understand the hazards involved. Children must not play with the appliance. Cleaning and user maintenance must not be carried out by children without supervision.

⚠ **WARNING:** The appliance and its accessible parts become hot during use. Care should be taken to avoid touching heating elements. Children less than 8 years of age must be kept away unless continuously supervised.

⚠ Never leave the appliance unattended during food drying. If the appliance is suitable for probe usage, only use a temperature probe recommended for this oven - risk of fire.

⚠ Keep clothes or other flammable materials away from the appliance, until all the components have cooled down completely - risk of fire. Always be vigilant when cooking foods rich in fat, oil or when adding alcoholic beverages - risk of fire. Use oven gloves to remove pans and accessories. At the end of cooking, open the door with caution, allowing hot air or steam to escape gradually before accessing the cavity - risk of burns. Do not obstruct hot air vents at the front of the oven - risk of fire.

⚠ Exercise caution when the oven door is in the open or down position, to avoid hitting the door.

## PERMITTED USE

⚠ **CAUTION:** The appliance is not intended to be operated by means of an external switching device, such as a timer, or separate remote controlled system.

⚠ This appliance is intended to be used in household and similar applications such as: staff kitchen areas in shops, offices and other working environments; farm houses; by clients in hotels, motels, bed & breakfast and other residential environments.

⚠ No other use is permitted (e.g. heating rooms).

# IMPORTANT TO BE READ AND OBSERVED

⚠ This appliance is not for professional use. Do not use the appliance outdoors.

⚠ Do not store explosive or flammable substances (e.g. gasoline or aerosol cans) inside or near the appliance - risk of fire.

## INSTALLATION

⚠ The appliance must be handled and installed by two or more persons - risk of injury. Use protective gloves to unpack and install - risk of cuts.

⚠ Installation, including water supply (if any) and electrical connections, and repairs must be carried out by a qualified technician. Do not repair or replace any part of the appliance unless specifically stated in the user manual. Keep children away from the installation site. After unpacking the appliance, make sure that it has not been damaged during transport. In the event of problems, contact the dealer or your nearest After-sales Service. Once installed, packaging waste (plastic, styrofoam parts etc.) must be stored out of reach of children - risk of suffocation. The appliance must be disconnected from the power supply before any installation operation - risk of electrical shock. During installation, make sure the appliance does not damage the power cable - risk of fire or electrical shock. Only activate the appliance when the installation has been completed.

⚠ Carry out all cabinet cutting works before fitting the appliance in the furniture and remove all wood chips and sawdust. Do not obstruct the minimum gap between the worktop and the upper edge of the oven - risk of burns.

Do not remove the oven from its polystyrene foam base until the time of installation.

⚠ After installation, the bottom of the appliance must no longer be accessible - risk of burn.

⚠ Do not install the appliance behind a decorative door - risk of fire.

## ELECTRICAL WARNINGS

⚠ The rating plate is on the front edge of the oven (visible when the door is open).

⚠ It must be possible to disconnect the appliance from the power supply by unplugging it if plug is accessible, or by a multi-pole switch installed upstream of the socket in accordance with the wiring rules and the appliance must be earthed in conformity with national electrical safety standards.

⚠ Do not use extension leads, multiple sockets or adapters. The electrical components must not be accessible to the user after installation. Do not use the appliance when you are wet or barefoot. Do not operate this appliance if it has a damaged power cable or plug, if it is not working properly, or if it has been damaged or dropped.

⚠ If the supply cord is damaged, it must be replaced with an identical one by the manufacturer, its service agent or similarly qualified persons in order to avoid a hazard - risk of electrical shock.

⚠ In case of replacement of power cable, contact an authorized service center.

### **CLEANING AND MAINTENANCE**

⚠ **WARNING:** Ensure that the appliance is switched off and disconnected from the power supply before performing any maintenance operation; never use steam cleaning equipment - risk of electric shock.

⚠ Do not use harsh abrasive cleaners or metal scrapers to clean the door glass since they can scratch the surface, which may result in shattering of the glass.

⚠ Ensure the appliance is cooled down before any cleaning or maintenance. - risk of burn.

⚠ **WARNING:** Switch off the appliance before replacing the lamp - risk of electrical shock.

### **DISPOSAL OF PACKAGING MATERIALS**

The packaging material is 100% recyclable and is marked with the recycle symbol . The various parts of the packaging must therefore be disposed of responsibly and in full compliance with local authority regulations governing waste disposal.

### **DISPOSAL OF HOUSEHOLD APPLIANCES**

This appliance is manufactured with recyclable or reusable materials. Dispose of it in accordance with local waste disposal regulations. For further information on the treatment, recovery and recycling of household electrical appliances, contact your local authority, the collection service for household waste or the store where you purchased the appliance. This appliance is marked in compliance with European Directive 2012/19/EU, Waste Electrical and Electronic Equipment (WEEE). By ensuring this product is disposed of correctly, you will help prevent negative consequences for the environment and human health.

The  symbol on the product or on the accompanying documentation indicates that it should not be treated as domestic waste but must be taken to an appropriate collection center for the recycling of electrical and electronic equipment.

### **ENERGY SAVING TIPS**

Only preheat the oven if specified in the cooking table or your recipe. Use dark lacquered or enamelled baking trays as they absorb heat better. Food requiring prolonged cooking will continue to cook even once the oven is switched off.

### **ECO DESIGN DECLARATION**

This appliance meets the Eco Design requirements of European Regulations n.65/2014 and 66/2014 in conformity to the European standard EN 60350-1.

# Installation

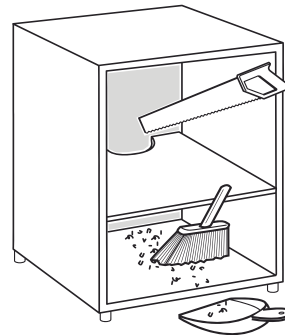
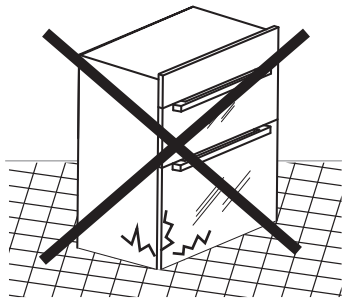
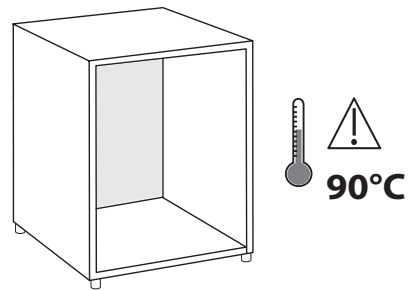
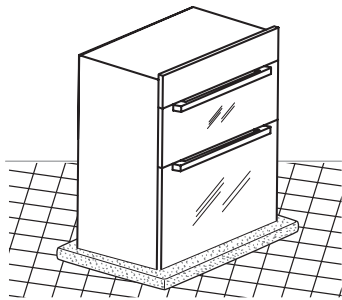
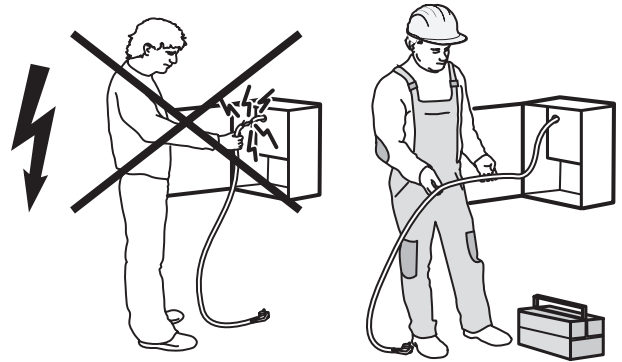
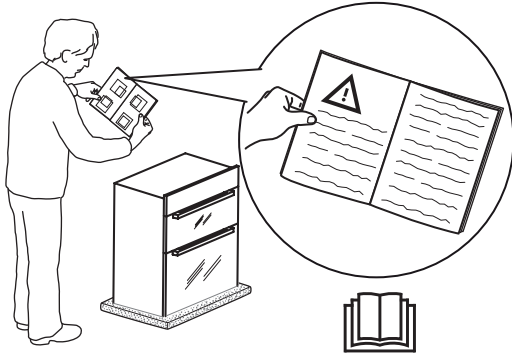
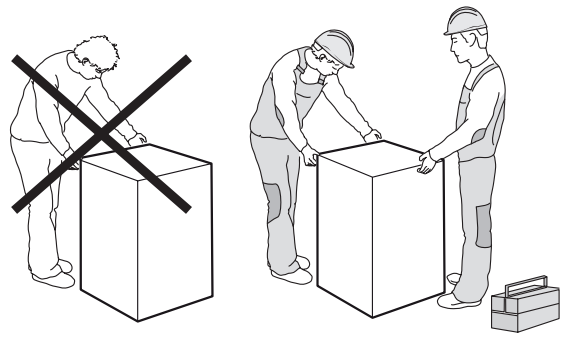
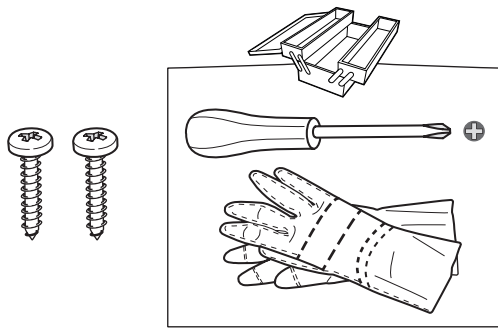

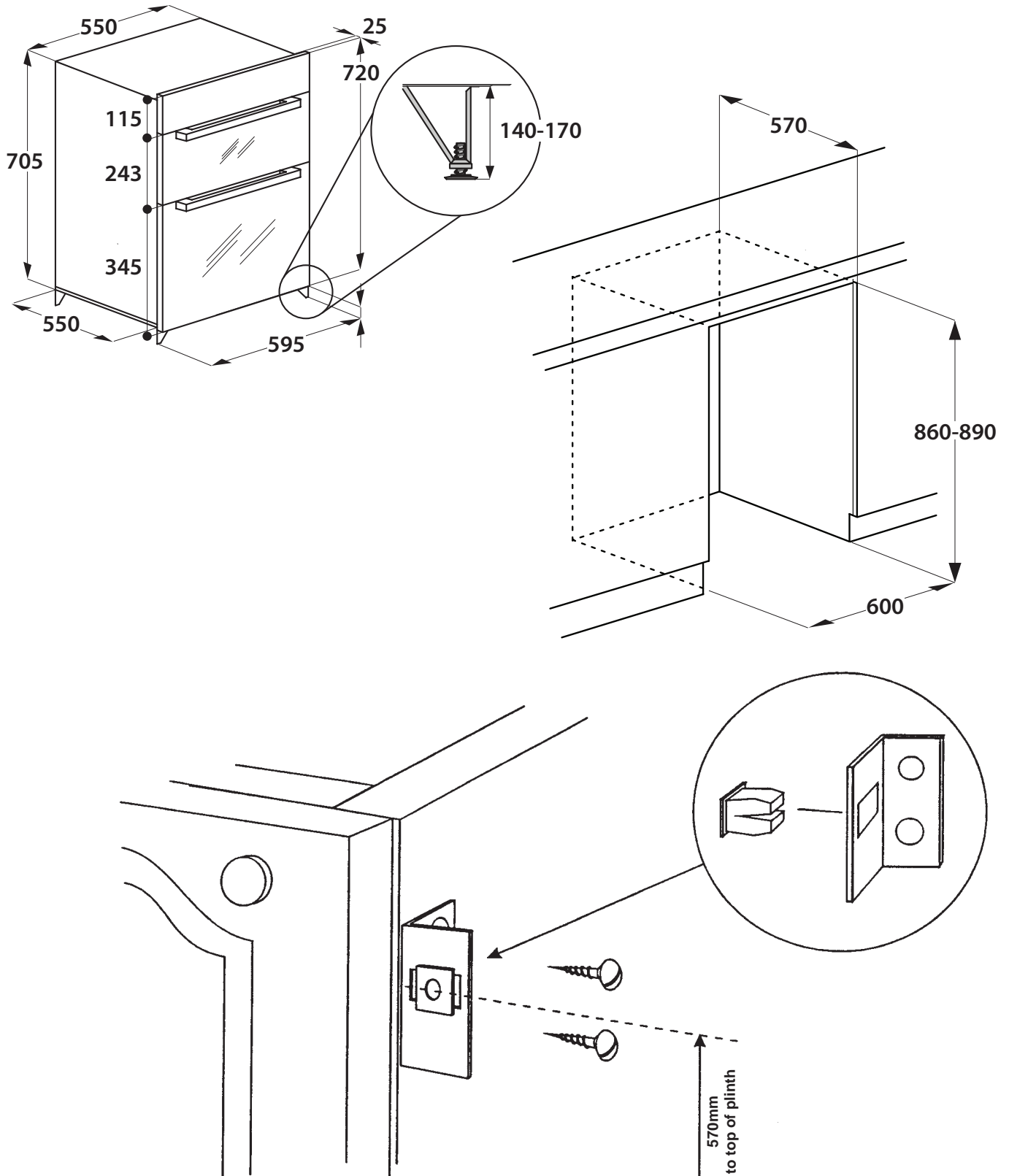

A minimum distance of 25mm should be maintained between the front face of the cabinet side and the front face of the plinth.

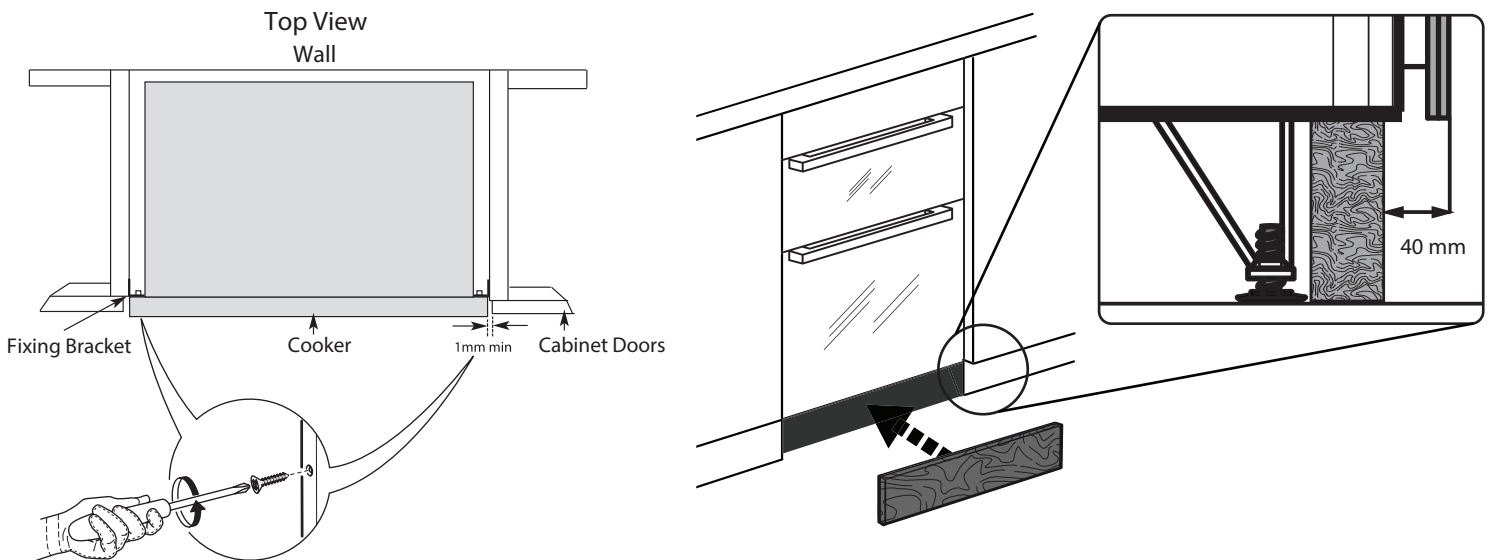
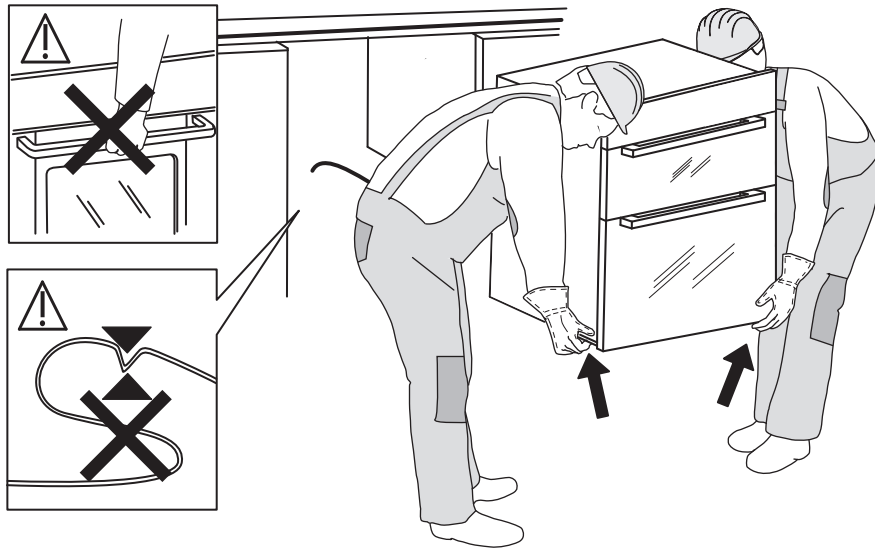
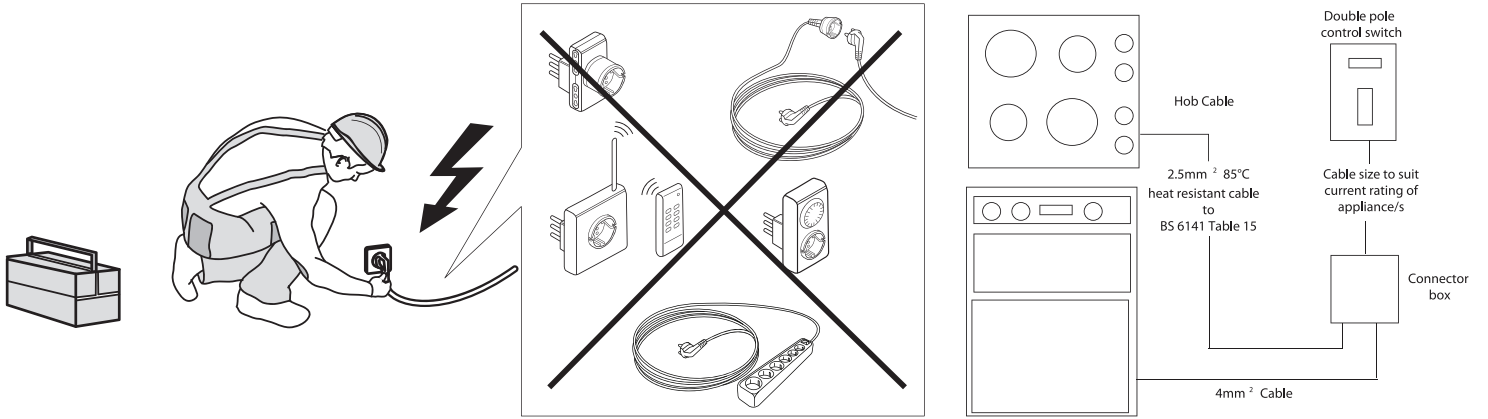
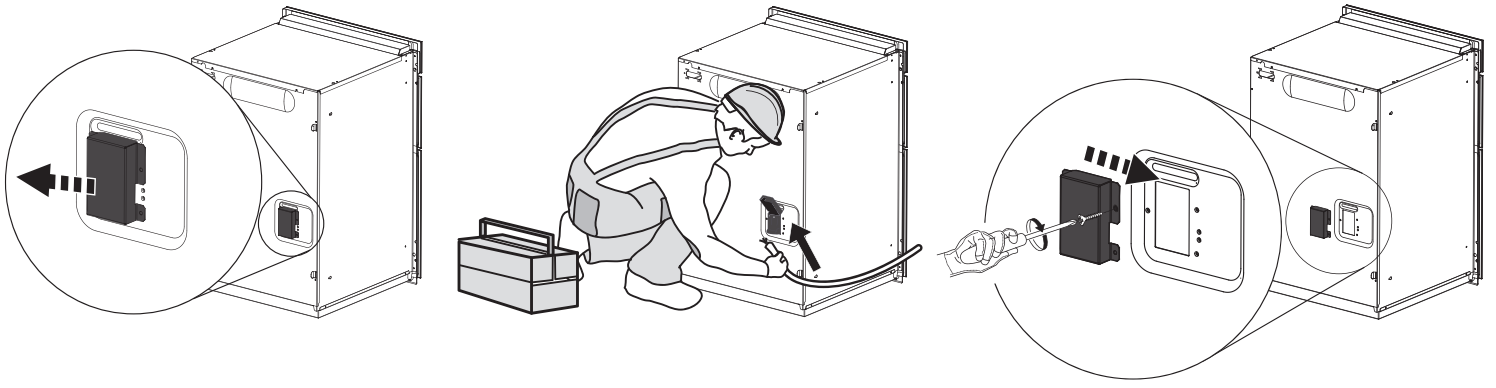

# The main parts of your Double Oven

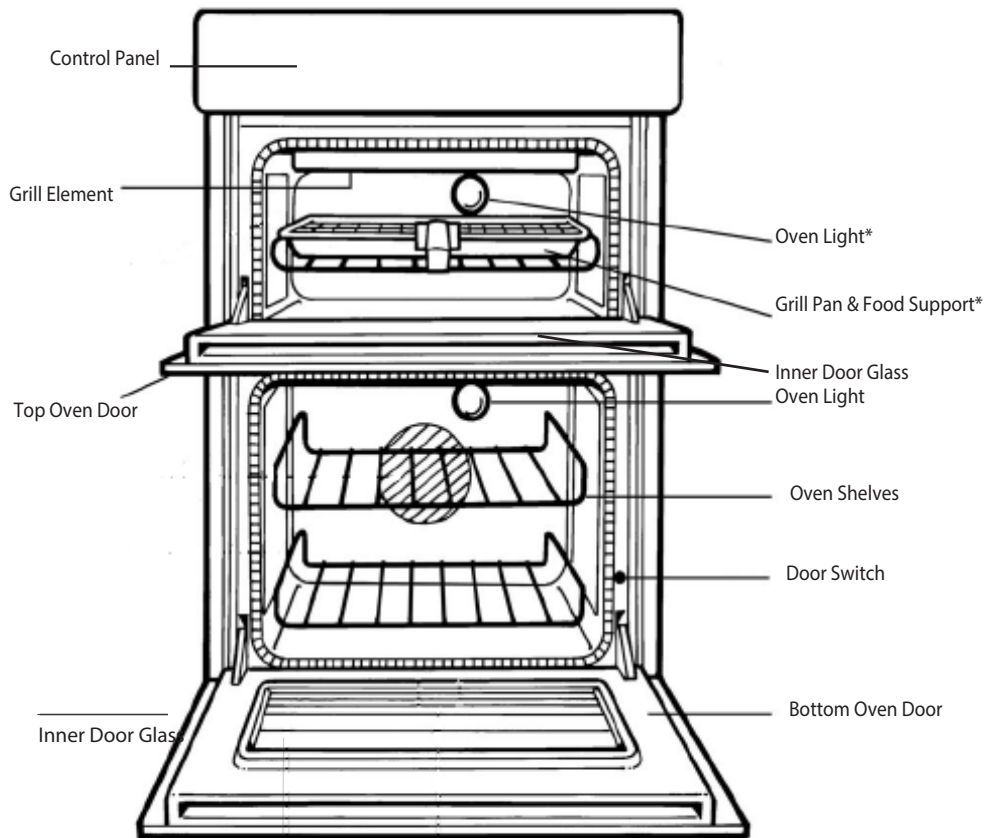

\* Only in some models

## Telescopic runners \*

The bottom oven on this cooker can come equipped with telescopic runners to facilitate inserting or removing accessories.

### Assembling the telescopic runners\*

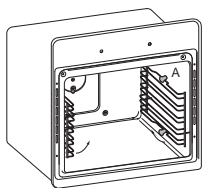

1. Remove the two frames, lifting them away from the spacers A (see figure).

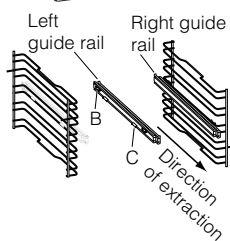

2. Choose which shelf to use with the sliding rack. Paying attention to the direction in which the sliding rack is to be extracted, position joint B and then joint C on the frame.

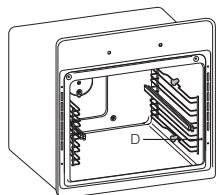

3. Secure the two frames with the guide rails using the holes provided on the oven walls (see diagram). The holes for the left frame are situated at the top, while the holes for the right frame are at the bottom.

4. Fit the frames on the spacers A.



# CONTROLS

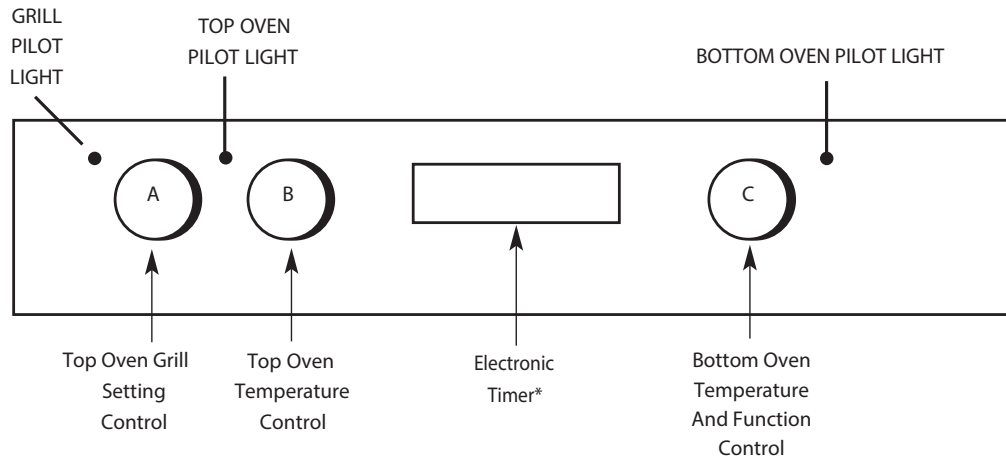

## A - Grill Setting Control

Selects the heat at which the grill will cook the food.

Grill Settings Control: MIN - MAX

## B - Top Oven Temperature Control

Selects the cooking temperature (Degrees Centigrade) when using the top oven as a conventional oven. 100 - MAX

## C - Bottom Oven Temperature & Function Control

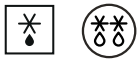

### Fan Only Setting

This is used to decrease the amount of time required to defrost food items.



### Oven Light Only

Switches on the Bottom Oven Interior Light Only Bottom Oven Temperature Scale (In Degrees Centigrade).

When cooking select the required cooking temperature.

## Bottom Oven Temperature Scale (In Degrees Centigrade). 80 - MAX

When cooking select the required cooking temperature.

## Cooling Fan

A gentle flow of air will be blown below the control panel when the grill control is used and after a short period of time when the ovens are used.

Note: Whenever the appliance has been used, the cooling fan may run on or restart itself after all the controls have been turned off. This indicates that the appliance is still warm.

## Oven Interior Lights

The oven lights are operated when their respective oven control is used. The bottom oven has a light only position.

## Slow Cooking

The bottom oven has a „Slow Cook Setting“ this can be used for slow cooking, keeping food warm and warming plates for a short period.

## TOP OVEN GRILLING

Step 1 Ensure oven timer is set to manual. Place the shelf in the correct position (see Grilling Guide).

Step 2 Place the food/grill pan on the shelf, positioned centrally under the grill element. Leave the top oven door fully open. Turn knob (A), clockwise for FULL grill or anticlockwise for HALF grill, to select the Grill Setting (MIN-MAX).

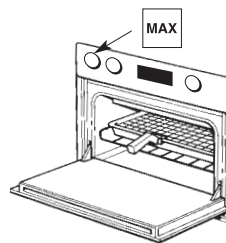

Grill Controls Example:

MAX = High Grill Setting (depending on model)

NOTE: Do not grill with the grill/top oven door closed.

Step 3 After use, turn the grill control (A) to the off position (0).

The Grill Pilot Light is on when grill is used. Ensure knob (B) is in „0 position“. The grill and the top oven cannot work simultaneously.

# THE ELECTRONIC PROGRAMMER

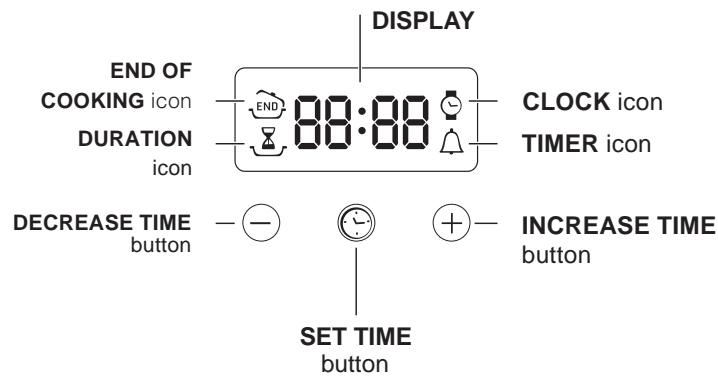

The Top Oven and Bottom Oven can be controlled by the automatic timer. When the timer control has been set for one oven, it is possible to use the other oven only during the same automatic cooking programme.

## Setting the clock

The clock may be set when the oven is switched off or when it is switched on, provided that a the end time of a cooking cycle has not been programmed previously.

After the appliance has been connected to the mains, or after a blackout, the icon and the four numerical digits on the DISPLAY will begin to flash.

1. Press the button several times until the icon and the four digits on the display begin to flash.
2. Use the "+" and "-" buttons to adjust the time; if you press and hold either button, the display will scroll through the values more quickly, making it quicker and easier to set the desired value.
3. Wait for 10 seconds or press the button again to finalise the setting.

## Setting the minute minder

This function does not interrupt cooking and does not affect the oven; it is simply used to activate the buzzer when the set amount of time has elapsed.

1. Press the button several times until the icon and the three digits on the display begin to flash.
2. Use the "+" and "-" buttons to set the desired time; if you press and hold either button, the display will scroll through the values more quickly, making it quicker and easier to set the value.
3. Wait for 10 seconds or press the button again to finalize the setting. The display will then show the time as it counts down. When this period of time has elapsed the buzzer will be activated.

## Programming cooking

A cooking mode must be selected before programming can take place.

1. Press the button several times until the icon and the three digits on the DISPLAY begin to flash.
2. Use the "+" and "-" buttons to set the desired duration; if you press and hold either button, the display will scroll through the values more quickly, making it quicker and easier to set the value.
3. Wait for 10 seconds or press the button again to finalise the setting.

4. When the set time has elapsed, the text END appears on the DISPLAY, the oven will stop cooking and a buzzer sounds. Press any button to stop the buzzer and turn all control knobs to 0 position.

For example: it is 9:00 a.m. and a time of 1 hour and 15 minutes is programmed. The programme will stop automatically at 10:15 a.m.

## Setting the end time for a cooking mode \*

A cooking duration must be set before the cooking end time can be scheduled.

1. Follow steps 1 to 3 to set the duration as detailed above.
2. Next, press the button until the icon and the four digits on the DISPLAY begin to flash.
3. Use the "+" and "-" buttons to adjust the cooking end time; if you press and hold either button, the display will scroll through the values more quickly, making it quicker and easier to set the desired value.
4. Wait for 10 seconds or press the button again to finalise the setting.
5. When the set time has elapsed, the text END appears on the DISPLAY, the oven will stop cooking and a buzzer sounds. Press any button to stop it. Programming has been set when the and buttons are illuminated.

The DISPLAY shows the cooking end time and the cooking duration alternately.

For example: It is 9:00 a.m. and a duration of 1 hour has been programmed. 12:30 is scheduled as the end time. The programme will start automatically at 11:30 a.m.

## Cancelling a programme

1. Press the button until the icon corresponding to the setting you wish to cancel and the digits on the display are flashing. Press the "-" button until the digits 00:00 appear on the display.
2. Press and hold the "+" and "-" buttons; this will cancel all the settings selected previously, including timer settings.

\* By selecting the grill function, you will not be able to set an end time.

# USING THE TOP OVEN FOR SOLARPLUS GRILLING

(ONLY IN SOME MODELS)

Solarplus high speed grill is designed to reduce your grilling times. It is quicker because it takes less time to warm up from cold. Conventional grills require 5 minutes pre-heat before food can be placed beneath them, but for

normal grilling the Solarplus grill can be used directly from cold without any pre-heat.

However, when toasting, optimum performance is achieved by pre-heating the grill for about 1 minute.

## GRILL PAN AND HANDLE

The grill pan handle is detachable from the pan to facilitate cleaning and storage.

Fix the pan handle securely before use:

Fit the handle to the grill pan so that the external 'hooks' embrace the edge of the pan (fig. 1)

Make sure that the middle part of the handle fits exactly the protruding support of the pan (fig. 2) and holds the pan from the bottom.

The food must be placed on the rack in the grill pan. Position the grill pan on top of the oven rack. The best results are achieved by placing the oven rack on the uppermost shelves. Pouring a little drinking water into the grill pan will make the collection of grease particles more efficient and prevent the formation of smoke.

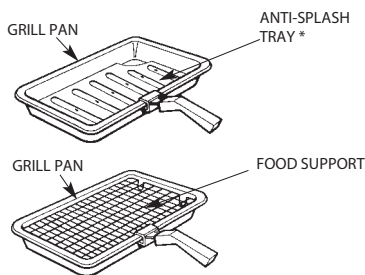
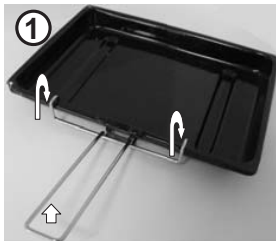

Note: To stop fat splashing onto the grill mesh, it is important to use the anti-splash tray as shown in the grilling chart. Always clean the grill pan, anti-splash tray \* and food support after each use.

## Top Oven Shelf Positioning for Grilling

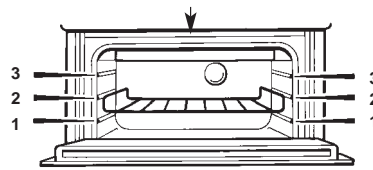

NOTE:

- Preheat the grill if indicated on grill chart.
- The grill pan must be placed on the correct shelf and positioned centrally under the grill element.

- Leave the control at MAX for toast, and for fast cooking of foods.
- For thicker foods requiring longer cooking, turn the switch to a lower setting after the initial sealing on both sides at MAX. The thicker the food, the lower the control should be set.
- After use always return the grill control to the OFF (1) position.

\* Only in some models

## USING THE TOP OVEN AS A CONVENTIONAL OVEN

The top oven should be used to cook small quantities of food. The oven is designed so that the grill element operates at a reduced heat output, this is combined with a heating element situated underneath the floor of the oven. To ensure even cooking of the food it is important that cooking utensils are positioned correctly on the oven shelf so that the element is directly above. As a guide, the front of the utensil should be approx. 100mm (4") from the front of the shelf.

### SHELF POSITIONING

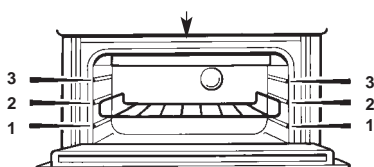

There should always be at least 25mm (1 inch) between the top of the food and the grill element.

### Operation when using the Top Oven as a Conventional Oven

Step 1 Check that the timer is in manual.

Step 2 Place the shelf in the correct position (see Oven Temperature Charts).

Step 3 Select the required cooking temperature (100 °C MAX) using control (B) (see Top Oven Temperature Charts). The pilot light will immediately come on, and remain on until the oven reaches the required temperature. The light will then automatically go off and on during cooking as the oven thermostat maintains the correct temperature.

Step 4 Place the food on the shelf directly below the element ensuring the oven door is closed.

NOTE: At the end of your cooking, always return control (B) to the OFF (O) position.

### PLATE WARMING

Place the plates/dishes on shelf position 1 from the base of the top oven, and turn top oven temperature control (B) to 100°C for 10-15 minutes.

# BOTTOM OVEN - FAN OVEN

---

**Important:** The oven is heated by elements at the rear of the oven. A fan at the rear of the oven operates to circulate heated air within the oven.

Operating procedure:

1. Ensure Oven Timer is set to Manual.
2. Turn the selector switch to the fan oven position, then turn the oven thermostat control to the required temperature setting (see oven temperature charts).

## BOTTOM OVEN - FAN OVEN COOKERY NOTES

---

Since a fan oven heats up more quickly, and generally cooks food at a lower temperature than a conventional oven, pre-heating the oven is often unnecessary. However, foods such as bread, scones, Yorkshire pudding, do benefit from being placed in a pre-heated oven.

The charts are a guide only, giving approximate cooking temperatures and times. To suit personal taste and requirements, it may be necessary to increase or decrease temperatures by 10°C.

Because the fan oven cooks so efficiently, we recommend that when cooking any recipes not designed for a fan oven, you reduce the temperature by about 25°C and the time by about 10 minutes in the hour. If large quantities are being cooked it will be necessary to increase the cooking time somewhat to compensate for the extra oven load.

Unless otherwise indicated in the charts, food is placed in a cold oven, i.e. without preheating.

If food is placed in an already hot oven, the suggested cooking time should be reduced, depending on the type and quantity of food being cooked.

It should be noted that at the end of a cooking period there may be a momentary puff of steam when the oven door is opened, this will disperse in a few seconds and is a perfectly normal characteristic of an oven with a good door seal.

3. The oven light will remain on. The oven indicator light will remain on until the oven reaches the set temperature. This light will then automatically cycle on and off during cooking as the oven temperature is controlled.

4. After use always return all controls to the off position and close the oven door.

### Oven Positions

Since the distribution of heat in the fan oven is very even, most foods will cook satisfactorily on any shelf position, but the shelves should be evenly spaced:

To ensure even circulation do not use meat pans larger than 390x300mm (15ins x 12ins) and baking trays no larger than 330x255mm (13ins x 10ins), these should be positioned centrally on the oven shelf.

Do not fit shelves upside down.

Never use more than 3 shelves in the oven as air circulation will be restricted.

Food or cooking utensils should not be placed on the floor of the oven. To avoid unnecessary cleaning, rod shelves which are not in use should be removed from the oven.

### Temperature and Time

The oven is provided with two shelves. A third is available as an optional extra, contact Genuine Parts and Accessories Hotline (see back page) for further information.

If three shelves are used to cook large quantities of food for home freezing or parties, it may be necessary to increase the cooking times given in the charts by a few minutes, to allow for the loss of heat due to the extra time taken to load the oven, and the larger mass of food.

Baking trays should allow an equal gap on all sides of the oven.

## **To prepare meat and poultry for Roasting in your Fan Oven**

(a) Wipe the meat or poultry, dry well and weigh it. Meat which has for been stored in a refrigerator should be allowed to come to room temperature before cooking, and frozen meat or poultry must be completely defrosted before placing in the oven. (b) The weight of any stuffing used should be added before calculating the cooking time. (c) Place meat/poultry in the bottom oven meat pan supplied with your cooker. Small joints weighing less than 1.75kg (3 1/2 lbs) should be roasted in a smaller meat pan/tin or they may be 'pot roasted' a small joint or a large meat pan causes unnecessary oven splashing and evaporation of meat juices.

(d) Additional fat should not be added, except for veal, very lean meat or poultry which can either be 'larded' with fat bacon or brushed very sparingly with cooking oil or melted fat.

(e) Beef, lamb, mutton and poultry may be dusted lightly with seasoned flour to give a crisp outer surface. The skin of duck and goose should be pricked to release excess fat during cooking, and the rind of pork should be scored, brushed lightly with oil, and rubbed with salt to give crisp crackling.

(f) Meat and poultry wrapped in, or covered with a tent of aluminium foil will be juicy and tender. Roasting bags offer the same advantages. Always follow the manufacturer's pack instructions, and remember to reduce the temperatures given for conventional ovens by approximately 25°C and the time by approximately 10 minutes per hour.

(g) Potatoes for roasting only require to be brushed with cooking oil or melted fat.

(h) It is not necessary to baste when roasting in an electric oven and stock or liquid should not be added to the meat pan since this only causes unnecessary soiling, steam and condensation.

## **Frozen Meat and Poultry**

Joints of meat and whole birds should be defrosted slowly, preferably in a domestic refrigerator (allowing 5-6 hours per 450g, 1 lb), or at room temperature (allowing 2-3 hours per 450g, 1 lb).

Frozen meat or poultry must be completely defrosted before placing in the oven.

It is essential to wash thoroughly and cook meat and poultry immediately after defrosting.

# Guide to Grilling

<b>FOOD</b>	<b>PREHEAT FOR 5 MINUTES</b> (depending on Model)	<b>SHELF POSITION FROM THE BASE OF THE OVEN</b>	<b>SETTING</b> (depending on Model)	<b>APPROXIMATE COOKING TIME</b>	<b>PAN TO BE USED</b>
Toasting of Bread Products	Setting MAX	3 or 2	Setting 4 or MAX	5 - 10 minutes	Grill pan and food support
Small cuts of meat, Sausage, Bacon	Setting MAX	3 or 2	Setting 4 or MAX for 4 minutes then reduce to LOWER setting	10 - 25 minutes	Grill pan and food support *
Chops etc. Gammon steaks	Setting MAX	2	Setting 4 or MAX for 6-8 minutes then reduce to LOWER setting	20 - 35 minutes	Grill pan and food support *
Fish: Whole Filletts Fingers	Setting MAX	2 3 3	Setting 4 or MAX	8 - 12 minutes 10 - 15 minutes 10 - 20 minutes	Grill pan and food support *
Pre-cooked potato products	Setting MAX	3 or 2	Setting 3 or lower setting	15 - 20 minutes	Grill pan and food support *
Browning of food eg. Cauliflower Cheese	Setting MAX	3 or 2	Setting 4 or MAX	10 - 20 minutes	Dish placed directly on the shelf

\* We recommend using the pan to collect the cooking juices: Position it below the food support and add 500 ml of drinking water.

# Oven Temperature Charts - Baking

## Top Oven - Conventional Cooking

Baking	Pre-heat	Temperature °C	Time in mins.	Position in Oven
Scones	Yes	210/220	10-15	Runner 2 from bottom of oven
Small Cakes	Yes	170/180	20-30	Runner 2 from bottom of oven
Victoria Sandwich	Yes	170/180	20-30	Runner 2 from bottom of oven
Sponge Sandwich (fatless)	Yes	180/190	20-25	Runner 2 from bottom of oven
Swiss Roll	Yes	200/210	10-15	Runner 2 from bottom of oven
Semi-rich Fruit cakes	Yes	150/160	60-75	Runner 2 from bottom of oven
Rich Fruit Cakes	Yes	140/150	Time Dependent on size	Runner 1 or 2 from bottom of oven
Shortcrust Pastry	Yes	170/180	Time Dependent on recipe	Runner 2 from bottom of oven
Puff Pastry	Yes	200/210	Time Dependent on recipe	Runner 1 from bottom of oven
Yorkshire Pudding	Yes	190/200	30-40	Runner 1 or 2 from bottom of oven
Individual Yorkshire Pudding	Yes	200/210	20-30	Runner 1 from bottom of oven
Milk Pudding	Yes	140/150	90-120	Runner 1 from bottom of oven
Baked Custard	Yes	150/160	40-50	Runner 1 from bottom of oven
Bread	Yes	200/210	30-45	Runner 1 from bottom of oven
Meringues	Yes	100	150-180	Runner 2 from bottom of oven

## Bottom oven - Fan Cooking

Baking	Pre-heat	Temperature °C	Time in mins.
Scones	Yes	210/220	9-12
Small Cakes	No	170/180	15-20
Victoria Sandwich	No	160/170	20-25
Sponge Sandwich (fatless)	Yes	190/200	15-20
Swiss Roll	Yes	190/200	10-15
Semi-rich Fruit cakes	No	140/150	1¼ - 1½ hrs
Rich Fruit Cakes	No	130/140	Depending on size
Shortcrust Pastry	No	190/200	Depending on size
Puff Pastry	No	190/200	Depending on size
Yorkshire Pudding	Yes	180/190	40-45
Individual Yorkshire Pudding	Yes	190/200	20-25
Milk Pudding	No	130/140	1½ - 2 hrs
Baked Custard	No	140/150	35-45
Bread	Yes	200/210	30-35
Meringues	No	80/90	3 - 4 hrs

# Oven Temperature Charts - Meat

## Top Oven - Conventional Cooking

Meat	Pre-heat	Temperature °C	Time (approx.)	Position in Oven
Beef/ Lamb (slow roasting)	Yes	170/180	35 mins per 450g (1lb) + 35 mins over.	Runner 2 from bottom of oven.
Beef/ Lamb (foil covered)	Yes	190/200	35-40 mins per 450g (1lb)	
Pork (slow roasting)	Yes	170/180	40 mins per 450g (1lb) + 40 mins over	
Pork (foil covered)	Yes	190/200	40 mins per 450g (1lb)	
Veal (slow roasting)	Yes	170/180	40-45 mins per 450g (1lb) + 40 mins over	
Veal (foil covered)	Yes	190/200	40-45 mins per 450g (1lb)	
Poultry/Game (slow roasting)	Yes	170/180	25-30 mins per 450g (1lb) + 25 mins over	
Poultry/Game (foil covered)	Yes	190/200	25-30 mins per 450g (1lb)	
Casserole Cooking	Yes	150	2-2½ hrs	

## Bottom oven - Fan Cooking

Meat	Pre-heat	Temperature °C	Time (approx.)	Position in Oven
Beef	No	160/180	20-25 mins per 450g (1lb) + 20 mins extra.	Runner 2 from bottom of oven.
Lamb	No	160/180	20-30 mins per 450g (1lb) +25 mins extra.	
Pork	No	160/180	25-30 mins per 450g (1lb) +25 mins extra.	
Veal	No	160/170	25-30 mins per 450g (1lb) +25 mins extra.	
Chicken/Turkey up to 4kg (8lb)	No	160/180	18-20 mins per 450g (1lb) + 20 mins extra.	
Turkey 4 to 5.5kg (8 to 12lb)	No	150/160	13-15 mins per 450g (1lb) at 150/160°C	
Turkey 4 to 5.5kg (8 to 12lb)		150	allow 12 mins per 450g (1lb) at 150°C	
Casserole Cooking	No	140-150	1½ - 2 hrs	

The most accurate method of testing the readiness of joints of meat or whole poultry is to insert a meat thermometer into the thickest part of a joint, or the thickest part of poultry thighs, during the cooking period. The meat thermometer will indicate when the required internal temp has been reached.

<b>Beef -</b>	Rare:	60°C	<b>Lamb:</b>	80°C	<b>Poultry:</b>	90°C
	Medium:	70°C	<b>Pork:</b>	90°C		
	Well Done:	75°C	<b>Veal:</b>	75°C		



# Care and Cleaning

**Do not use steam cleaning equipment.**

**Use protective gloves during all operations.**

**Carry out the required operations with the oven cold.**

**Disconnect the appliance from the power supply.**

**Do not use wire wool, abrasive scourers or abrasive/corrosive cleaning agents, as these could damage the surfaces of the appliance.**

## EXTERIOR SURFACES

- Clean the surfaces with a damp microfibre cloth. If they are very dirty, add a few drops of pH-neutral detergent. Finish off with a dry cloth.
- Do not use corrosive or abrasive detergents. If any of these products inadvertently comes into contact with the surfaces of the appliance, clean immediately with a damp microfibre cloth.

## INTERIOR SURFACES

- After every use, leave the oven to cool and then clean it, preferably while it is still warm, to remove any deposits or stains caused by food residues. To dry any condensation that has formed as a result of cooking foods with a high water content, allow the oven to cool completely and then wipe it with a cloth or sponge.
- The door can be easily removed and refitted to facilitate cleaning of the glass.
- Clean the glass in the door with a suitable liquid detergent.

## REPLACEMENT OF THE OVEN LAMP

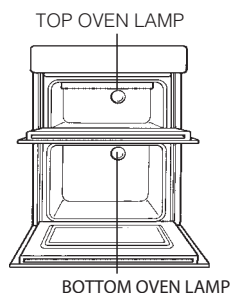

Disconnect the oven from the power supply. Unscrew the cover from the light, replace the bulb (25W - 230V - T 300 °C - E14) and screw the cover back on the light. Reconnect the oven to the power supply.

The bulb used in the product is specifically designed for domestic appliances and is not suitable for general room lighting within the home (EC Regulation 244/2009). Light bulbs are available from our After-sales Service. If using halogen bulbs, do not handle them with your bare hands as your fingerprints could cause damage. Do not use the oven until the light cover has been refitted.

## ACCESSORIES

Soak the accessories in a washing-up liquid solution after use, handling them with oven gloves if they are still hot. Food residues can be removed using a washing-up brush or a sponge.

## Catalytic Cleaning \*

In some models, the most exposed internal vertical sides of the oven are coated with porous enamel, which is called catalytic enamel. When heated, this enamel destroys fat particles given off by the food. This „oxidation“ of the fat particles occurs when the temperature of the sides exceeds 170°C. The porous quality of the catalytic enamel increases the surface area where the exchange vital to the oxidation of the fats takes place.

If there is still grime on the catalytic surfaces after the cooking programme has ended, leave the empty oven on with the door shut, turning the temperature adjustment knob to its maximum setting. Leave the oven like this for a period of time between 60 and 90 minutes, according to how much dirt was left inside. The cleaning process for more stubborn food residues may be quickened by using hot water and a soft brush.

\* Only in some models

# Troubleshooting

Any problems that arise or faults that occur can often be resolved easily. Before contacting the After-sales Service, check the following table to see whether you can resolve the problem yourself. If the problem persists, contact your nearest After-sales Service Centre.



**Read the safety instructions carefully before carrying out any of the following work**

PROBLEM	POSSIBLE CAUSE	REMEDY
The oven is not working.	Power cut. Disconnection from the mains. Malfunction.	Check for the presence of mains electrical power and whether the oven is connected to the electricity supply. Turn off the oven and restart it to see if the problem persists.

## AFTER-SALES SERVICE

### BEFORE CONTACTING OUR AFTER-SALES SERVICE

**1.** Check whether you can resolve the problem yourself using any of the measures described in the Troubleshooting section.

**2.** Turn off the oven and restart it to see if the problem persists.

To receive assistance, call the number given on the warranty leaflet enclosed with the product or follow the instructions on our website. Be prepared to provide:

- a brief description of the problem;
- the exact model type of your product;
- the assistance code (the number following the word SERVICE on the identification plate attached to the product, which can be seen on the inside edge when the oven door is open);
- your full address;
- a contact telephone number.

**SERVICE** 0000 000 00000



Please note: If repairs are required, contact an authorised service centre that is guaranteed to use original spare parts and perform repairs correctly.

Please refer to the enclosed warranty leaflet for more information on the warranty.





**400011203496**