

THANK YOU FOR PURCHASING A ARISTON PRODUCT.

To receive more comprehensive assistance, register the appliance on [www.aristonchannel.com/register](http://www.aristonchannel.com/register)



Before using the appliance carefully read the Health and Safety guide.

⚠ Before using the machine, it is imperative that the transport bolts are removed. For more detailed instructions on how to remove them, see the Installation Guide.

CONTROL PANEL

1. STEAM HYGIENE / MUTE button
2. FINAL CARE / KEY LOCK button
3. ON/OFF button
4. ACTIVE CARE button and indicator light
5. START/PAUSE button
6. RAPID/ECO button
7. SPIN button
8. START DELAY button
9. TEMPERATURE button
10. WASH CYCLE SELECTOR KNOB
11. Programme key

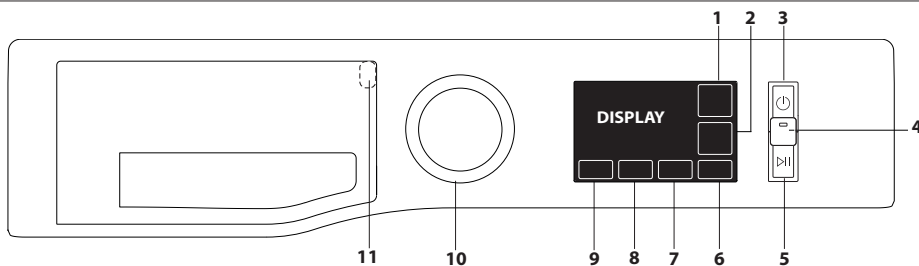

WASH CYCLE TABLE

Maximum load 9 kg  
Power input in off mode 0.5 W / in left-on mode 8 W

Wash cycle	Temperature		Max. spin speed (rpm)	Max. load (kg)	Duration (minutes)	Active Care	Add Garments	Detergents and Additives			Recommended detergent		Residual dampness %	Energy consumption kWh	Total water l
	Default	Range						Pre-wash	Wash	Fabric softener	Powder	Liquid			
								1	2	3					
1 Mixed	40°C	☼ - 40°C	1400	9	**	●	●	-	●	○	-	✓	-	-	-
2 Eco Cotton (1)	60°C	60°C	1400	9	**	-	●	-	●	○	✓	✓	-	-	-
		40°C	1400	9	**	-	●	-	●	○	✓	✓	-	-	-
3 Cotton	40°C	☼ - 60°C	1400	9	**	-	●	-	●	○	✓	✓	-	-	-
4 Synthetics	40°C	☼ - 60°C	1200	4,5	**	-	●	-	●	○	✓	✓	-	-	-
5 Delicates	40°C	☼ - 40°C	1000	4,5	**	●	●	-	●	○	-	✓	-	-	-
6 Wool	40°C	☼ - 40°C	800	2	**	-	●	-	●	○	-	✓	-	-	-
7 Anti Allergy	60°C	40°C - 60°C	1400	5	**	-	●	-	●	○	✓	✓	-	-	-
8 Anti Stain 40°	40°C	☼ - 40°C	1000	4,5	**	●	●	-	●	○	✓	✓	-	-	-
9 White	40°C	☼ - 90°C	1400	9	**	●	●	● (***)	●	○	✓	✓	-	-	-
10 Steam Refresh	-	-	-	2	**	-	-	-	-	-	-	-	-	-	-
11 Rapid 30 min	30°C	☼ - 30°C	1200	4,5	**	●	●	-	●	○	-	✓	-	-	-
12 Bed & Bath	60°C	☼ - 60°C	1400	9	**	●	●	-	●	○	✓	✓	-	-	-
13 Shirts	40°C	☼ - 40°C	1200	2	**	-	●	-	●	○	-	✓	-	-	-
14 Spin & Drain *	-	-	1400	9	**	-	-	-	-	-	-	-	-	-	-
15 Rinse & Spin	-	-	1400	9	**	-	-	-	-	○	-	-	-	-	-

● Required dosage ○ Optional dosage

The cycle duration indicated on the display or instruction manual is an estimate based on standard conditions. The actual duration may vary in relation to several factors, such as the temperature and pressure of the incoming water, ambient temperature, amount of detergent, load quantity and type, load balancing and any additional options selected.

1) Test Programmes according to SASO 2885:2018: set wash cycle 2 with a temperature of 60°C for Cotton Standard 60°C and with a temperature of 40°C for Cotton Standard 40°C.

\* By selecting the 14 cycle and excluding the spin cycle, the washing machine will drain only.

\*\* The duration of the wash cycles can be checked on the display.

\*\*\* For Prewash press the "Temp." button until the symbol lights up (only 90°).

Data referred to SASO 2885/2018 Standard cycles

Phase	Info	Standard Cotton 60°C Full load	Standard Cotton 60°C Half load	Standard Cotton 40°C half load
Washing phase	Number	1	1	1
	Time (min)	161	115	109
	Water (L)	22	14,7	15
Rinse phase	Number	2	2	2
	Time (min) rinse 1	11	7	7
	Water (L) rinse 1	11,3	17,5	18
	Time (min) rinse 2	11	8	8
Spin phase	Water (L) rinse 2	12,6	19,8	19,6
	Number	3	3	3
	Time (min) spin 1	6	9	7
	Time (min) spin 2	11	8	8
	Time (min) spin 3	21	17	19

DETERGENT DISPENSER DRAWER

compartment 1: Pre-wash detergent (powder)

compartment 2: Detergent for the wash cycle (powder or liquid)

If liquid detergent is used, it is recommended that the removable plastic partition A (supplied) be used for proper dosage.

If powder detergent is used, place the partition into slot B.

compartment 3: Additives (fabric softeners, etc.)

The fabric softener should not overflow the grid.

! Use powder detergent for white cotton garments, for pre-washing, and for washing at temperatures over 60°C.

! Follow the instructions given on the detergent packaging.

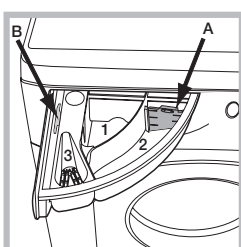

PRODUCT DESCRIPTION

1. Top
2. Detergent dispenser drawer
3. Control panel
4. Handle
5. Porthole door
6. Drain pump (behind the plinth)
7. Plinth (removable)
8. Adjustable feet (2)

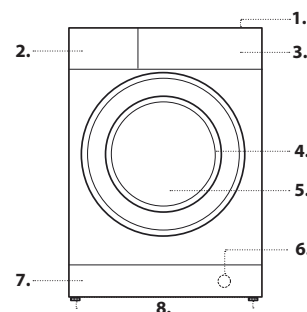

The "Programme key" situated inside the detergent dispenser shows all the available wash cycles together with a graphic guide on how to use the individual dispenser compartments.

## WASH CYCLES

Follow the instructions on the symbols of the garment's wash care label. The value indicated in the symbol is the maximum recommended temperature for washing the garment.



### Mixed

For washing lightly to normally soiled resilient garments in cotton, linen, synthetic fibres and mixed fibres.

### Eco Cotton

Suitable for washing moderately soiled cotton garments. At 40°C and 60°C it is the standard cycle for washing cotton garments, and is the most efficient in terms of combined water and electricity consumption.

### Cotton

Normally to heavily soiled and robust cottons.

### Synthetics

Suitable for washing moderately soiled garments made of synthetic fibres (e.g. polyester, polyacrylic, viscose, etc.) or mixed synthetic-cotton fibres.

### Delicates

For washing very delicate garments. It is advisable to turn the garments inside out before washing them. For best results, use liquid detergent on delicate garments.

### Wool - Wool Care

The wool wash cycle of this machine has been approved by The Woolmark Company for the washing of machine washable wool products provided that the products are washed according to the instructions on the garment label and those issued by the manufacturer of this washing machine. The Woolmark symbol is a Certification mark in many countries. M2225.



### Anti Allergy

Suitable for removing major allergens such as pollen, mites and cat or dog hair.

### Anti Stain 40°

The programme is suitable to heavily-soiled garments with resistant colours. It ensures a washing class that is higher than the standard class (A class). When running the programme, do not mix garments of different colours. We recommend the use of powder detergent. Pre-treatment with special additives is recommended if there are obstinate stains.

### White

For washing normally to heavily soiled towels, underwear, table and bed linen, etc in resilient cotton and linen. Only when the temperature is selected at 90°C the cycle is provided with a prewash phase before main washing phase. In this case it is recommended to add detergent both, in the prewash and main wash section.

### Steam Refresh

The garments will be damp once the cycle is completed, so we recommend hanging them to dry (2 kg, roughly 3 items). This programme refreshes garments by removing bad odours and relaxing the fibres. Insert dry items only (that are not dirty) and select programme "Steam Refresh". Garments will be a little damp at the end of the cycle and can be worn after a few minutes. The "Steam Refresh" programme makes ironing easier.

! Do not add softeners or detergents.

! Not recommended for wool or silk garments.

### Rapid 30 min

For washing lightly soiled garments quickly. This cycle lasts only 30 minutes, saving time and energy.

### Bed & Bath

For washing home linen in a single cycle. It optimises the use of fabric softener and allows for saving time and electricity. We recommend the use of powder detergent.

### Shirts

Use the special wash cycle to wash shirts in different fabrics and colours to guarantee they receive the best possible care.

### Spin & Drain

Spins the load then empties the water. For resilient garments. If you exclude the spin cycle, the machine will drain only

### Rinse & Spin

Rinses and then spins. For resilient garments.

## DISPLAY

The display is useful when programming the washing machine and provides plenty of information.

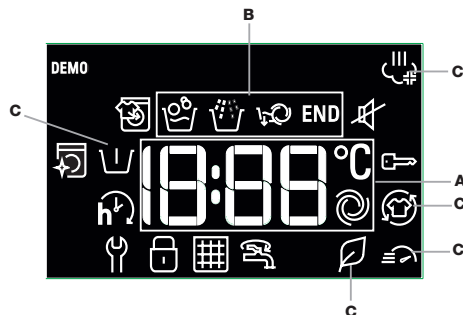

The duration of the available wash cycles and the remaining time of a running cycle appear in section **A** (the display will show the maximum duration of the cycle chosen, which may decrease after several minutes, since the effective duration of the programme varies depending on the wash load and the settings chosen); if the DELAYED START option has been set, the countdown to the start of the selected wash cycle will appear. Pressing the corresponding button allows you to view the maximum spin speed and temperature values attained by the machine during the set wash cycle, or the values selected most recently, if these are compatible with the set wash cycle.

The "wash cycle phases" corresponding to the selected wash cycle and the "wash cycle phase" of the running wash cycle appear in section **B**:

Main wash

Rinse

Spin + Pump out

References **C** indicate the wash options available (See "Options" section).

The symbol , when lit, indicates that the set "delayed start" value has appeared on the display.

The symbol , indicates the possibility of inserting an additional garments load with the washing program started (See "Adding Garments" section).

The , indicates the possibility to silence the key tones

While the mute is active, almost all sounds will be turned off. Only the sound signals and the alarms remain active, as well as the sound of the end of cycle. For activate/deactivate the mute press and hold button.

### Key Lock

To lock the control panel, press and hold the button for approximately 3 seconds. The symbol will light up on the display to indicate that the control panel has been locked (with the exception of the "ON/OFF" button). This prevents unintentional changes to programmes, especially with children near the machine. To unlock the control panel, press and hold the button for approximately 3 seconds.

### Locked door indicator

When lit, the symbol indicates that the door is locked. To prevent any damage, wait until the symbol turns off before opening the door.

To open the door while a cycle is in progress, press the START/PAUSE if the symbol is off, the door can be opened.

## FIRST-TIME USE

Once the appliance has been installed, and before you use it for the first time, run a wash cycle with detergent and no laundry, using the wash cycle **9 (60°)**.

## DAILY USE

Prepare the laundry by following the suggestions appearing under the "TIPS AND SUGGESTIONS" section.

- Press the ON/OFF button .

- Open the door. Load the laundry while making sure not to exceed the maximum load quantity indicated in the wash cycle table.

- Pull out the detergent dispenser drawer and pour the detergent into the relevant compartments, as described in the "DETERGENT DISPENSER DRAWER" section.

- Close the door.

- The machine automatically displays the default temperature and spin speed values for the selected cycle, or the most recently used settings if they are compatible with the selected cycle.

- Select the desired wash cycle.

- Select the desired options.

### STARTING CYCLE

- Press the start/pause button.

The machine will lock the door ( symbol on) and the drum will start to rotate; the door will be unlocked ( symbol OFF) and then locked again ( symbol on) as preparation phase of each washing cycle. The "Clicking" noise is part of the door locking mechanism. Water will enter the drum and start the washing phase once the door is locked.

## PAUSING A CYCLE

To pause the wash cycle, press the START/PAUSE button again. To start the wash cycle from the point at which it was interrupted, press the START/PAUSE button again.

## OPENING THE DOOR, IF NECESSARY

Once a cycle starts, the symbol turns on to signal that the door cannot be opened. While a wash cycle is running, the door remains locked. To open the door while a cycle is under way, for example, to add or remove garments, press the START/PAUSE button to pause the cycle. If the symbol is not lit, the door may be opened. Press the START/PAUSE button again to continue the cycle.

## ADDING GARMENTS

An icon on the display will signal when additional garments can be introduced into the washing machine, without decreasing the washing performance. To add garments, first stop the washing machine by pressing the START/PAUSE button then open the door and insert them. Press the START/PAUSE button again to restart the wash cycle from the point at which it was interrupted.

## CHANGING A RUNNING WASH CYCLE

To change a wash cycle while it is in progress, pause the washing machine using the START/PAUSE >|| button, then select the desired cycle and press the START/PAUSE >|| button again.

! To cancel a cycle that has already begun, press and hold the ON/OFF ⏻ button. The cycle will be stopped and the machine will switch off.

## AT THE END OF THE WASH CYCLE

This will be indicated by the word "END" on the display; when the  symbol switches off, the door may be opened. Open the door, unload the laundry and switch off the machine. If you do not press ON/OFF ⏻ button, the washing machine will switch off automatically after about 15 minutes.

## OPTIONS

- If the selected option is not compatible with the set wash cycle, the indicator light will flash accompanied by a buzzer and the option will not be activated.
- If the selected option is not compatible with another previously selected option, the indicator light will flash accompanied by a buzzer and the option will not be activated.

### Steam Hygiene

This option enhances washing performance by generating steam during the wash cycle to remove any bacteria from the fibres, which are treated at the same time. Place the laundry in the drum, choose a compatible programme and select option Steam Hygiene.

! The steam generated during the operation of the washing machine may cause the porthole door to become hazy.

### Rapid/Eco

After pushing the button for the 1st time, option Rapid is selected and the cycle duration will be reduced.

Otherwise after pushing for the 2nd time, option Eco is selected allowing more energy saving.

### Final Care

The washing machine will perform gentle tumbling through slow rotations of the drum. Final Care option starts after the cycle ends for a maximum duration of 6h and you can interrupt at any time by pressing any button on control panel or turning the knob.

### Active Care

The detergent, premixed with water, creates an unique emulsion able to better penetrate the fibers of the garments, cleaning stains at even low temperatures, preserving both colors and fabrics. These results are obtained also due to the multiple different specific movements of the drum which best take care of the garments.

### Start Delay

To set a delayed start for the selected cycle, press the corresponding button repeatedly until the desired delay period is reached. When this option has been activated, the  symbol lights up on the display. To remove the delayed start setting, press the button until "OFF" appears on the display.

### Temperature

Each wash cycle has a pre-defined temperature. To modify the temperature, press the "Temp." button. The value will appear on the display.

### Spin

Each wash cycle has a pre-defined spin speed. To modify the spin speed, press the "Spin Speed" button. The value will appear on the display.

## DESCALE AND CLEAN PROCEDURE

An icon  on the display will regularly (roughly every 50 cycles) remind users that it is time to run a maintenance cycle to clean the washing machine and combat limescale build-up and bad odours.

To delete the descale alert turn the knob or push any button (including ON/OFF button).

For optimal maintenance we suggest using WPRO Limescale and grease remover, according to the instructions shown on the package.

The product can be purchased by contacting the technical assistance service or through the website [www.aristonchannel.com](http://www.aristonchannel.com)

The Company declines all liability for any damages to the appliance caused by the use of other cleaning products for washing machines available on the market.

## TIPS AND SUGGESTIONS

### Divide the laundry according to:

Type of fabric (cotton, mixed fibres, synthetics, wool, garments to be hand-washed). Colour (separate coloured garments from whites, wash new coloured garments separately). Delicates (small garments – such as nylon stockings – and items with hooks – such as bras: insert them in a fabric bag).

### Empty the pockets:

Objects such as coins or lighters can damage the washing machine and the drum. Check all buttons.

## CARE AND MAINTENANCE

*Before performing cleaning and maintenance, switch the washing machine off and disconnect it from the mains power. Do not use flammable liquids to clean the washing machine.*

### Cutting off the water and electricity supplies

Close the water tap after every wash. This will limit wear on the hydraulic system inside the washing machine and help to prevent leaks.

Unplug the washing machine when cleaning it and during all maintenance work.

### Cleaning the washing machine

The outer parts and rubber components of the appliance can be cleaned using a soft cloth soaked in lukewarm soapy water. Do not use solvents or abrasives.

### Cleaning the detergent dispenser drawer

Remove the dispenser drawer by lifting and pulling it outwards. Wash it under running water; this procedure should be effected regularly.

### Caring for the door and drum

Always leave the porthole door ajar in order to prevent unpleasant odours from forming.

### Cleaning the pump

The washing machine is fitted with a self-cleaning pump that does not require any maintenance. Small items (such as coins or buttons) may sometimes fall into the protective pre-chamber situated at the base of the pump.

! Make sure that the wash cycle has ended and unplug the appliance.

To access the pre-chamber:

1. remove the covering panel on the front side of the machine by inserting a screwdriver in the centre and sides of the panel and using it as a lever;
2. place a low and wide container under the water filter in order to collect the residual water.
3. loosen the drainage pump cover by turning it anti-clockwise: it is normal for some water to leak out;
4. clean the inside thoroughly;
5. screw the cover back on;
6. put the panel back in place, making sure the hooks slot in place before pushing the panel onto the appliance.

### Checking the water inlet hose

Check the water inlet hose at least once a year. If it is cracked or broken, it must be replaced: during wash cycles, the high pressure of the water could suddenly split the hose open.

! Never use hoses that have already been used.

## ANTIMICROBIAL SEAL

The seal around the porthole door is made from a special mixture ensuring antimicrobial protection, thus reducing bacterial proliferation up to 99.99%.

The seal contains zinc pyrithione, a biocidal substance which reduces the proliferation of harmful microbes (\*) such as bacteria and mould prone to causing stains, unpleasant odours and product deterioration.

(\*) According to tests performed by the University of Perugia, Italy

on: Staphylococcus aureus, Escherichia coli, Pseudomonas aeruginosa, Candida albicans, Aspergillus niger, Penicillium digitatum

In rare cases an allergic reaction may be caused by prolonged contact between seal and skin.

## ACCESSORIES

Contact our Technical Assistance Service to check whether the following accessories are available for this washing machine model.

### Stacking kit

With this accessory you can secure the tumble dryer to the upper part of your washing machine to save space and facilitate loading and unloading of the tumble dryer.







## TRANSPORT AND HANDLING

*Do not lift the washing machine by gripping it from the upper section.*

Unplug the appliance and close the water tap. Check that the door and detergent dispenser drawer are tightly closed. Detach the filling hose from the water tap then detach the drain hose. Empty all the water remaining in the hoses and secure the latter so that they do not get damaged during transport. Apply the transport bolts back on. Repeat, in reverse order, the transport bolt removal procedure described in the "Installation instructions".

## TROUBLESHOOTING

Your washing machine could occasionally fail to work. Before contacting the Technical Assistance Service, make sure that the problem cannot be easily solved using the following list.

Anomalies	Possible causes / Solution
<b>The washing machine does not start.</b>	The appliance is not plugged into the socket fully, or not enough to make contact.
	There is no power in the house.
<b>The wash cycle does not start.</b>	The washing machine door is not closed properly.
	The ON/OFF  button has not been pressed.
	The START/PAUSE  button has not been pressed.
	The water tap has not been opened.
	A delay has been set for the start time.
	The Demo Mode is active (see below how to deactivate).
<b>The washing machine does not fill with water (“ ” appears on the display).</b>	The water inlet hose is not connected to the tap.
	The hose is bent.
	The water tap has not been opened.
	There is no water supply in the house.
	The pressure is too low.
<b>The washing machine continuously loads and unloads water.</b>	The START/PAUSE  button has not been pressed.
	The drain hose is not fitted between 65 and 100 cm from the floor.
	The free end of the hose is immersed in water.
	The wall drainage system is not fitted with a breather pipe.  If the problem persists even after these checks, turn off the water tap, switch the appliance off and contact the Technical Assistance Service. If the home is on one of the upper floors of a building, there may be problems relating to back-siphonage, causing the washing machine to fill with water and drain continuously. Special anti-siphon valves are available in shops and help to prevent this inconvenience.
<b>The washing machines does not drain and the symbol  (F9E1) on the display.</b>	Clean the pump filter (see Care and maintenance chapter)
	The drain hose is bent.
	The drainage duct is clogged.
<b>The washing machine vibrates a lot during the spin cycle.</b>	Transport bolts have been not removed correctly during installation.
	The washing machine is not leveled.
	The washing machine is tucked between furniture cabinets and the wall.
<b>The washing machine leaks.</b>	The water inlet hose is not screwed on properly.
	The detergent dispenser drawer is obstructed.
	The drain hose is not properly attached.
<b>The  symbol blinks and the display visualises an error code (e.g.: F1E1, F4...).</b>	Switch off the machine and unplug it, wait for approximately 1 minute and then switch it back on again. If the problem persists, contact the Technical Assistance Service.
<b>There is too much foam.</b>	The detergent is not suitable for machine washing (it should display the text “for washing machines” or “hand and machine wash”, or the like).
	Too much detergent was used.
<b>“ ” phase icon blinks, “0” spin speed displayed .</b>	Unbalance of laundry load prevented spin cycle, to protect the washing machine. If you want to spin the wet laundry, add more laundry items of different sizes and start “Spin&Drain” programme. Avoid small laundry loads consisting of few big, absorbent pieces of laundry / wash different sizes of articles in one load.

*Disable the DEMO MODE: The following actions must be carried out in sequence, without breaks. Switch the machine ON and then switch it OFF again. Press the START/PAUSE  button until the buzzer is heard. Switch the machine on again. The “DEMO” indicator flashes and then turns OFF.*



You can download the **SAFETY AND INSTALLATION INSTRUCTIONS, OPERATING MANUAL, TECHNICAL SHEET and ENERGY DATA** by:

- Visiting the website <http://aristonchannel.com>
- Using the QR code.
- Alternatively, **contact our Technical Assistance Service** (the telephone number is indicated in the warranty booklet). When contacting the Technical Assistance Service, provide the codes shown on the adhesive label applied to the inside of the door.

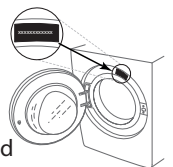

# INSTRUCTION SHEET

<b>Manufacturer's name</b>	Whirlpool Management EMEA S.r.l. - Via Carlo Pisacane n.1 - 20016 Pero (MI) - Italy
<b>Description model</b>	NLM11 946 WC A 60Hz
<b>Country of production</b>	Poland
<b>Rated Voltage (V)</b>	220/240 V
<b>Rated Frequency (Hz)</b>	60 Hz
<b>Rated Power (W)</b>	1850 W
<b>Net Weight (kg)</b>	74 kg
<b>Rated Capacity (kg)</b>	9 kg
<b>Annual Energy Consumption (kWh/year)</b>	158 kWh/year
<b>Annual Water Consumption (liters/year)</b>	11550 liters/year
<b>Dimensions</b>	width 59.5 cm height 85 cm depth 60,5 cm
<b>Connecting the drain hose</b>	<p>Connect the drain hose, without bending it, to a drain duct or a wall drain situated between 65 and 100 cm from the floor.</p> <p>Alternatively, place the drain hose over the edge of a washbasin or bathtub, by fastening the guide  (which can be purchased at the technical assistance centre) to the tap. The free end of the hose should not be underwater.</p> <p>! We advise against the use of hose extensions; if it is absolutely necessary, the extension must have the same diameter as the original hose and must not exceed 150 cm in length.</p>
<b>Electrical connections</b>	<p>Before plugging the appliance into the mains socket, make sure that:</p> <ul style="list-style-type: none"><li>• the socket is earthed and in compliance with the applicable law;</li><li>• the socket is able to sustain the appliance's maximum power load indicated on the Technical Data Plate fixed on the machine;</li><li>• the supply voltage is included within the values indicated on the Technical Data Plate fixed on the machine.</li><li>• the socket is compatible with the washing machine's plug. If this is not the case, replace the socket or the plug.</li></ul>
<b>General safety</b>	<ul style="list-style-type: none"><li>• This appliance was designed for domestic use only.</li><li>• This appliance can be used by children aged from 8 years and above and persons with reduced physical, sensory or mental capabilities or lack of experience and knowledge if they have been given supervision or instruction concerning use of the appliance in a safe way and understand the hazards involved. Children shall not play with the appliance. Cleaning and user maintenance shall not be made by children without supervision.</li><li>• Do not touch the machine when barefoot or with wet or damp hands or feet.</li><li>• Do not pull on the power supply cable when unplugging the appliance from the electricity socket. Hold the plug and pull.</li><li>• Do not open the detergent dispenser drawer while the machine is in operation.</li><li>• Do not touch the drained water as it may reach extremely high temperatures.</li><li>• Never force the porthole door. This could damage the safety lock mechanism designed to prevent accidental opening.</li><li>• If the appliance breaks down, do not under any circumstances access the internal mechanisms in an attempt to repair it yourself.</li><li>• Always keep children well away from the appliance while it is operating.</li><li>• The door can become quite hot during the wash cycle.</li><li>• If the appliance has to be moved, work in a group of two or three people and handle it with the utmost care. Never try to do this alone, because the appliance is very heavy.</li><li>• Before loading laundry into the washing machine, make sure the drum is empty.</li><li>• This machine must not be operated in a non air-conditioned environment.</li></ul>
<b>Unpacking and levelling</b>	<ol style="list-style-type: none"><li>1. Remove the washing machine from its packaging.</li><li>2. Make sure that the washing machine has not been damaged during the transportation process. If it has been damaged, contact the retailer and do not proceed any further with the installation process.</li><li>3. Remove the 4 protective screws (used during transportation) and the rubber washer with the corresponding spacer, located on the rear part of the appliance.</li><li>4. Close off the holes using the plastic plugs provided.</li><li>5. Keep all the parts in a safe place: you will need them again if the washing machine needs to be moved to another location.</li></ol> <p>! Packaging materials should not be used as toys for children.</p>



