

Instructions for use

WASHING MACHINE

GB

GB

English, 1

FR

Français, 13

AR

عربي , 25

Contents

Installation, 2-3

Unpacking and levelling
Connecting the electricity and water supplies
The first wash cycle
Technical data

Care and maintenance, 4

Cutting off the water and electricity supplies
Cleaning the washing machine
Cleaning the detergent dispenser drawer
Caring for the door and drum of your appliance
Cleaning the pump
Checking the water inlet hose

Precautions and tips, 5

General safety
Disposal

Description of the washing machine, 6-7

Control panel
Display

Running a wash cycle, 8

Wash cycles and options, 9

Table of programmes and wash cycles
Wash options

Detergents and laundry, 10

Detergent dispenser drawer
Preparing the laundry
Special wash cycles
Load balancing system

Troubleshooting, 11

Service, 12

RPG 9447



ARISTON

Installation

GB

! This instruction manual should be kept in a safe place for future reference. If the washing machine is sold, transferred or moved, make sure that the instruction manual remains with the machine so that the new owner is able to familiarise himself/herself with its operation and features.

! Read these instructions carefully: they contain vital information relating to the safe installation and operation of the appliance.

Unpacking and levelling

Unpacking

1. Remove the washing machine from its packaging.
2. Make sure that the washing machine has not been damaged during the transportation process. If it has been damaged, contact the retailer and do not proceed any further with the installation process.

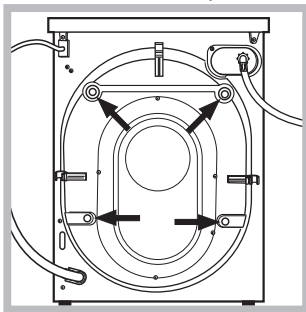

3. Remove the 4 protective screws (used during transportation) and the rubber washer with the corresponding spacer, located on the rear part of the appliance (see figure).

4. Close off the holes using the plastic plugs provided.
 5. Keep all the parts in a safe place: you will need them again if the washing machine needs to be moved to another location.
- ! Packaging materials should not be used as toys for children.

Levelling

1. Install the washing machine on a flat sturdy floor, without resting it up against walls, furniture cabinets or anything else.

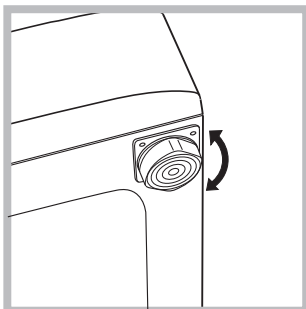

2. If the floor is not perfectly level, compensate for any unevenness by tightening or loosening the adjustable front feet (see figure); the angle of inclination, measured in relation to the worktop, must

not exceed 2°.

Levelling the machine correctly will provide it with stability, help to avoid vibrations and excessive noise and prevent it from shifting while it is operating. If it is placed on carpet or a rug, adjust the feet in such a way as to allow a sufficient ventilation space underneath the washing machine.

Connecting the electricity and water supplies

Connecting the water inlet hose

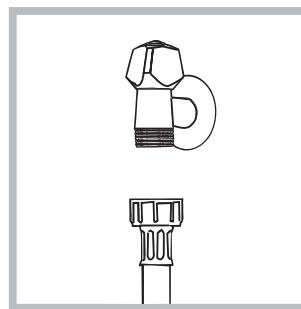

1. Connect the inlet hose by screwing it to a cold water tap using a 3/4 gas threaded connection (see figure).

Before performing the connection, allow the water to run freely until it is perfectly clear.

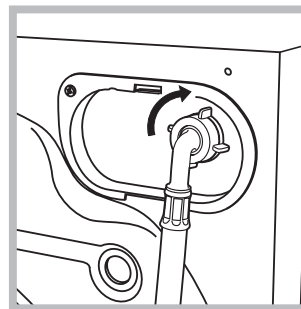

2. Connect the inlet hose to the washing machine by screwing it onto the corresponding water inlet of the appliance, which is situated on the top right-hand side of the rear part of the appliance (see figure).

figure).

3. Make sure that the hose is not folded over or bent.

! The water pressure at the tap must fall within the range of values indicated in the Technical data table (see next page).

! If the inlet hose is not long enough, contact a specialised shop or an authorised technician.

! Never use second-hand hoses.

! Use the ones supplied with the machine.

Connecting the drain hose

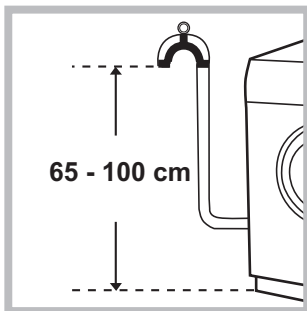

Connect the drain hose, without bending it, to a drain duct or a wall drain situated between 65 and 100 cm from the floor;

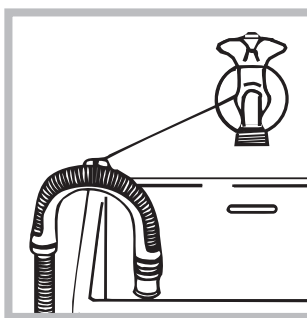

alternatively, placed it over the edge of a basin, sink or tub, fastening the duct supplied to the tap (see figure). The free end of the hose should not be underwater.

! We advise against the use of hose extensions; if it is absolutely necessary, the extension must have the same diameter as the original hose and must not exceed 150 cm in length.

Electrical connections

Before plugging the appliance into the electricity socket, make sure that:

- the socket is earthed and complies with all applicable laws;
- the socket is able to withstand the maximum power load of the appliance as indicated in the Technical data table (see opposite);
- the power supply voltage falls within the values indicated in the Technical data table (see opposite);
- the socket is compatible with the plug of the washing machine. If this is not the case, replace the socket or the plug.

! The washing machine must not be installed outdoors, even in covered areas. It is extremely dangerous to leave the appliance exposed to rain, storms and other weather conditions.

! When the washing machine has been installed, the electricity socket must remain within easy reach.

! Do not use extension cords or multiple sockets.

! The cable should not be bent or compressed.

! The power supply cable must only be replaced by authorised technicians.

Warning! The company shall not be held responsible in the event that these standards are not observed.

The first wash cycle

Once the appliance has been installed, and before you use it for the first time, run a wash cycle with detergent and no laundry, using wash cycle number auto clean (see “Cleaning the washing machine”).

Technical data

Model	RPG 9447
Dimensions	width 59,5 cm height 85 cm depth 60,5 cm
Capacity	from 1 to 9 kg
Electrical connections	please refer to the technical data plate fixed to the machine
Water connections	maximum pressure 1 MPa (10 bar) minimum pressure 0.05 MPa (0.5 bar) drum capacity 62 litres
Spin speed	up to 1400 rotations per minute
Test wash cycles in accordance with regulations 1061/2010 1015/2010	programme 9 ; Eco Cotton (60°). programme 9 ; Eco Cotton (40°).
	This appliance conforms to the following EC Directives: - EMC - 2014/30/EU (Electromagnetic Compatibility) - LVD - 2014/35/EU (Low Voltage) - 2012/19/EU (WEEE)

Care and maintenance

GB

Cutting off the water and electricity supplies

- Turn off the water tap after every wash cycle. This will limit wear on the hydraulic system inside the washing machine and help to prevent leaks.
- Unplug the washing machine when cleaning it and during all maintenance work.

Cleaning the washing machine

- The outer parts and rubber components of the appliance can be cleaned using a soft cloth soaked in lukewarm soapy water. Do not use solvents or abrasives.
- The washing machine has a auto clean programme for its internal parts that **must be run with no load in the drum**.

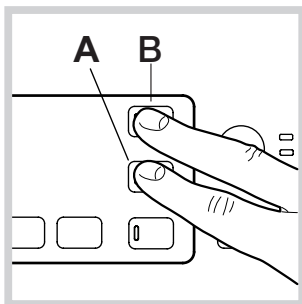

To help the wash cycle you may want to use either the detergent (i.e. a quantity 10% the quantity specified for lightly-soiled garments) or special additives to clean the washing machine. We recommend running a

cleaning programme every 40 wash cycles. To start the programme press buttons **A** and **B** simultaneously for 5 seconds (see figure). The programme will start automatically and will run for about 70 minutes. To stop the cycle press the START/PAUSE button.

Cleaning the detergent dispenser drawer

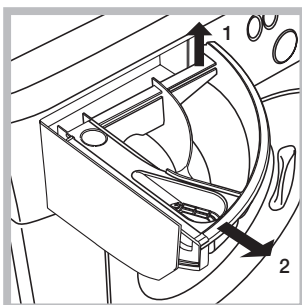

Remove the dispenser by raising it and pulling it out (see figure). Wash it under running water; this operation should be repeated frequently.

Caring for the door and drum of your appliance

- Always leave the porthole door ajar in order to prevent unpleasant odours from forming.

Cleaning the pump

The washing machine is fitted with a self-cleaning pump which does not require any maintenance. Sometimes, small items (such as coins or buttons) may fall into the pre-chamber which protects the pump, situated in its bottom part.

! Make sure the wash cycle has finished and unplug the appliance.

To access the pre-chamber:

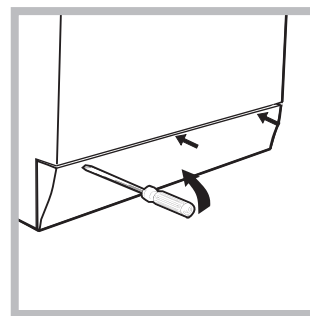

1. using a screwdriver, remove the cover panel on the lower front part of the washing machine (see figure);

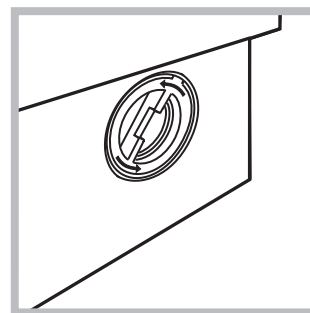

2. unscrew the lid by rotating it anti-clockwise (see figure): a little water may trickle out. This is perfectly normal;

3. clean the inside thoroughly;
4. screw the lid back on;
5. reposition the panel, making sure the hooks are securely in place before you push it onto the appliance.

Checking the water inlet hose

Check the inlet hose at least once a year. If there are any cracks, it should be replaced immediately: during the wash cycles, water pressure is very strong and a cracked hose could easily split open.

! Never use second-hand hoses.

! This washing machine was designed and constructed in accordance with international safety regulations. The following information is provided for safety reasons and must therefore be read carefully.

General safety

- This appliance was designed for domestic use only.
- This appliance can be used by children aged from 8 years and above and persons with reduced physical, sensory or mental capabilities or lack of experience and knowledge if they have been given supervision or instruction concerning use of the appliance in a safe way and understand the hazards involved. Children shall not play with the appliance. Cleaning and user maintenance shall not be made by children without supervision.
- Do not touch the machine when barefoot or with wet or damp hands or feet.
- Do not pull on the power supply cable when unplugging the appliance from the electricity socket. Hold the plug and pull.
- Do not open the detergent dispenser drawer while the machine is in operation.
- Do not touch the drained water as it may reach extremely high temperatures.
- Never force the porthole door. This could damage the safety lock mechanism designed to prevent accidental opening.
- If the appliance breaks down, do not under any circumstances access the internal mechanisms in an attempt to repair it yourself.
- Always keep children well away from the appliance while it is operating.
- The door can become quite hot during the wash cycle.
- If the appliance has to be moved, work in a group of two or three people and handle it with the utmost care. Never try to do this alone, because the appliance is very heavy.
- Before loading laundry into the washing machine, make sure the drum is empty.

Disposal

- Disposing of the packaging materials: observe local regulations so that the packaging may be re-used.
- The European Directive 2012/19/EU on Waste Electrical and Electronic Equipment, requires that old household electrical appliances must not be disposed of in the normal unsorted municipal waste stream. Old appliances must be collected separately in order to optimise the recovery and recycling of the materials they contain and reduce the impact on human health and the environment. The crossed out “wheeled bin” symbol on the product reminds you of your obligation, that when you dispose of the appliance it must be separately collected. Consumers should contact their local authority or retailer for information concerning the correct disposal of their old appliance.

Description of the washing machine

GB

Control panel

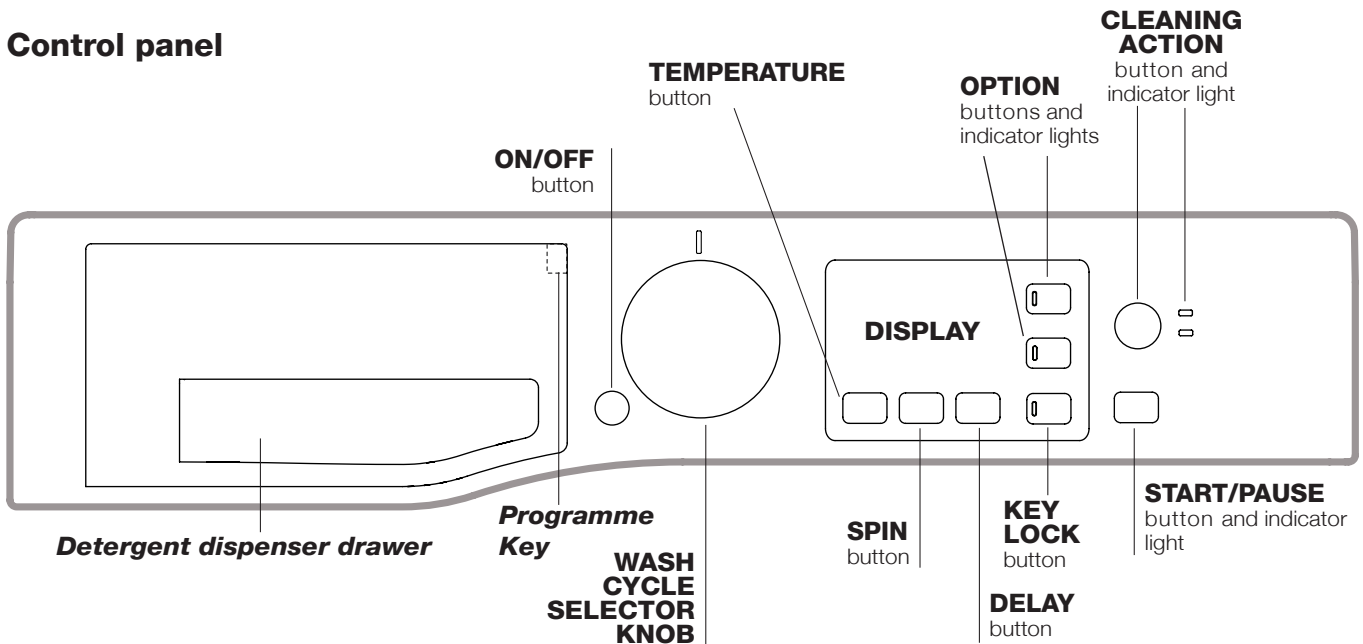

Detergent dispenser drawer: used to dispense detergents and washing additives (see “Detergents and laundry”).

Programme Key: the Programme Key inside the detergent dispenser shows all the available programmes together with a graphical guide on how to use the individual dispenser compartments.

ON/OFF  button: press this briefly to switch the machine on or off. The START/PAUSE indicator light which flashes slowly in a green colour shows that the machine is switched on. To switch off the washing machine during the wash cycle, press and hold the button for approximately 3 seconds; if the button is pressed briefly or accidentally the machine will not switch off. If the machine is switched off during a wash cycle, this wash cycle will be cancelled.

WASH CYCLE SELECTOR KNOB: used to set the desired wash cycle (see “Table of programmes and wash cycles”).

OPTION buttons and indicator lights: press to select the available options. The indicator light corresponding to the selected option will remain lit.

CLEANING ACTION button and indicator light : to select the desired wash intensity.

TEMPERATURE  button: press to reduce or completely exclude the temperature; the value appears on the display.

SPIN  button: press to reduce or completely exclude the spin cycle; the value appears on the display.

DELAY  button: press to set a delayed start for the selected wash cycle; the delay period appears on the display.

START/PAUSE button and indicator light: when the green indicator light flashes slowly, press the button to start a wash cycle. Once the cycle has begun the indicator light will remain lit in a fixed manner. To pause the wash cycle, press the button again; the indicator light will flash in an amber colour. If the  symbol is not illuminated, the door may be opened. To start the wash cycle from the point at which it was interrupted, press the button again.

KEY LOCK button: to activate the control panel lock, press and hold the button for approximately 2 seconds. When the symbol  is illuminated, the control panel is locked (apart from the ON/OFF button). This means it is possible to prevent wash cycles from being modified accidentally, especially where there are children in the home. To deactivate the control panel lock, press and hold the button for approximately 2 seconds.

Standby mode

This washing machine, in compliance with new energy saving regulations, is fitted with an automatic standby system which is enabled after about 30 minutes if no activity is detected. Press the ON-OFF button briefly and wait for the machine to start up again.

Antimicrobial seal

The seal around the porthole door is made from a special mixture ensuring antimicrobial protection, thus reducing bacterial proliferation up to 99.99%.

The seal contains zinc pyrithione, a biocidal substance which reduces the proliferation of harmful microbes (*) such as bacteria and mould prone to causing stains, unpleasant odours and product deterioration.

(*) **According to tests performed by the University of Perugia, Italy on:** *Staphylococcus aureus, Escherichia coli, Pseudomonas aeruginosa, Candida albicans, Aspergillus niger, Penicillium digitatum.*
In rare cases an allergic reaction may be caused by prolonged contact between seal and skin.

Display

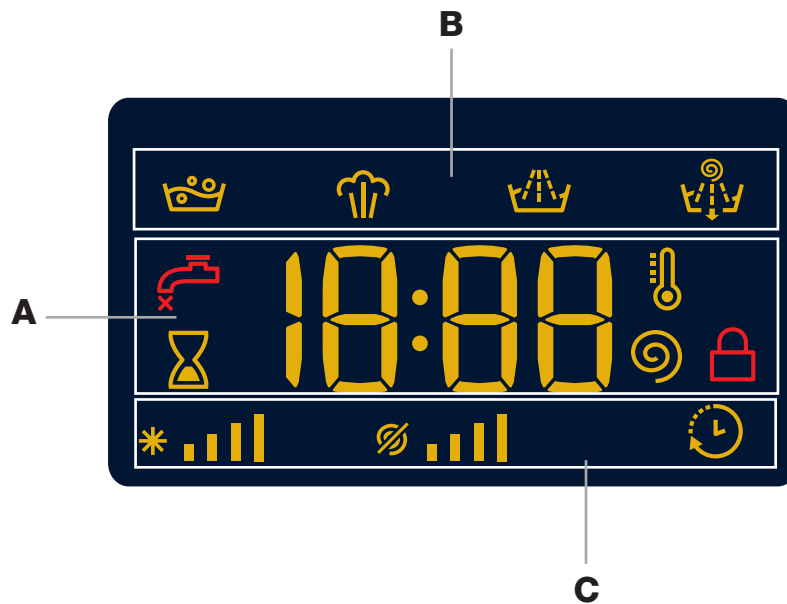

The display is useful when programming the machine and provides a great deal of information.

The duration of the available wash cycles and the remaining time of a running cycle appear in section **A** (the display will show the maximum duration of the cycle chosen, which may decrease after several minutes, since the effective duration of the programme varies depending on the wash load and the settings chosen); if the DELAY option has been set, the countdown to the start of the selected wash cycle will appear.

Pressing the corresponding button allows you to view the maximum spin speed and temperature values attained by the machine during the set wash cycle, or the values selected most recently, if these are compatible with the set wash cycle.

The “wash cycle phases” corresponding to the selected wash cycle and the “wash cycle phase” of the running wash cycle appear in section **B**:

- Main wash
- Steam
- Rinse
- Spin / Pump out

The icons corresponding to “temperature”, “spin” and “delayed start” (working from the left) are displayed in section **C**.

The “temperature” bars * indicate the maximum temperature level which may be selected for the set cycle.

The “spin” bars indicate the maximum spin level which may be selected for the set cycle.

The “delay” symbol , when lit, indicates that the set “delayed start” value has appeared on the display.

DOOR LOCKED indicator light:

The lit symbol indicates that the door is locked. To prevent any damage, wait until the symbol turns off before opening the door.



To open the door while a cycle is in progress, press the START/PAUSE button; if the DOOR LOCKED symbol is switched off the door may be opened.

Running a wash cycle

GB

1. **SWITCH THE MACHINE ON.** Press the  button; the START/PAUSE indicator light will flash slowly in a green colour.
2. **LOAD THE LAUNDRY.** Open the porthole door. Load the laundry, making sure you do not exceed the maximum load value indicated in the table of programmes and wash cycles on the following page.
3. **MEASURE OUT THE DETERGENT.** Pull out the detergent dispenser drawer and pour the detergent into the relevant compartments as described in “*Detergents and laundry*”.
4. **CLOSE THE DOOR.**
5. **SELECT THE WASH CYCLE.** Use the WASH CYCLE SELECTOR knob to select the desired wash cycle. A temperature and spin speed is set for each wash cycle; these values may be adjusted. The duration of the cycle will appear on the display.
6. **CUSTOMISE THE WASH CYCLE.** Use the relevant buttons:

Modify the temperature and/or spin speed.

The machine automatically displays the maximum temperature and spin speed values set for the selected cycle, or the most recently-used settings if they are compatible with the selected cycle. The temperature can be decreased by pressing the  button, until the cold wash “OFF” setting is reached. The spin speed may be progressively reduced by pressing the  button, until it is completely excluded (the “OFF” setting). If these buttons are pressed again, the maximum values are restored.

! Exception: if the 3 programme is selected, the temperature can be increased up to a value of 90°C.

! Exception: if the 4 programme is selected, the temperature can be increased up to a value of 60°C.

Setting a delayed start.

To set a delayed start for the selected cycle, press the corresponding button repeatedly until the required delay period has been reached. When this option has been activated, the  symbol lights up on the display. To remove the delayed start setting, press the button until the text “OFF” appears on the display.

Set the desired wash intensity.

Option  makes it possible to optimise washing based on the level of soil in the fabrics and on desired wash cycle intensity.

For heavily-soiled garments press  button until the “Intensive” level is reached. This level ensures a high-performance wash due to a larger quantity of water used in the initial phase of the cycle and due to increased drum rotation. It is useful when removing the most stubborn stains.

For lightly-soiled garments or a more delicate treatment of the fabrics, press  button until the “Delicate” level is reached. The cycle will reduce drum rotation to ensure washing results that are perfect for delicate garments.

Modify the cycle settings.

- Press the button to enable the option; the indicator light corresponding to the button will switch on.
- Press the button again to disable the option; the indicator light will switch off.



! If the selected option is not compatible with the set wash cycle, the indicator light will flash and the option will not be activated.

! If the selected option is not compatible with a previously selected one, the indicator light corresponding to the first function selected will flash and only the second option will be activated; the indicator light for the option which has been activated will be illuminated.

! The options may affect the recommended load value and/or the duration of the cycle.

7. START THE WASH CYCLE.

Press the START/PAUSE button.

The machine will lock the door ( symbol on) and the drum will start to rotate; the door will be unlocked ( symbol OFF) and then locked again ( symbol on) as preparation phase of each washing cycle. The “Clicking” noise is part of the door locking mechanism. Water will enter the drum and start the washing phase once the door is locked.

To change a wash cycle while it is in progress, **pause the washing machine** using the START/PAUSE button (the START/PAUSE indicator light will flash slowly in an amber colour); then select the desired cycle and press the START/PAUSE button again.

To open the door while a cycle is in progress, press the START/PAUSE button; if the DOOR LOCKED  symbol is switched off the door may be opened. Press the START/PAUSE button again to restart the wash cycle from the point at which it was interrupted.

8. **THE END OF THE WASH CYCLE.** This will be indicated by the text “END” on the display; when the DOOR LOCKED  symbol switches off the door may be opened. Open the door, unload the laundry and switch off the machine.

! If you wish to cancel a cycle which has already begun, press and hold the  button. The cycle will be stopped and the machine will switch off.

Table of programmes and wash cycles

Wash cycles	Description of the wash cycle	Max. temp. (°C)	Max. speed (rpm)	Detergents		Max. load (kg)	Residual dampness%	Energy consumption kWh	Total water lit	Cycle duration
				Wash	Fabric softener					
DAILY CLEAN										
1	Anti Stain	40°	1400	●	●	5	-	-	-	**
2	Anti Stain Quick	40°	1200	●	●	4,5	-	-	-	**
3	Cotton: lightly soiled resistant and delicate colours.	40° (Max. 90°C)	1400	●	●	9	-	-	-	**
4	Synthetics (3): lightly soiled resistant colours.	40° (Max. 60°C)	1000	●	●	4,5	46	0,56	65	125'
5	Fast 30': to refresh lightly soiled garments quickly (not suitable for wool, silk and clothes which require washing by hand).	30°	800	●	●	3,5	71	0,20	38	30'
SPECIALS										
6	Steam Refresh	-	-	-	-	1,5	-	-	-	**
7	Ultadelicates	30°	0	●	●	1	-	-	-	**
8	Wool: for wool, cashmere, etc.	40°	800	●	●	2	-	-	-	**
9	Eco Cotton (1): heavily soiled whites and resistant colours.	60°	1400	●	●	9	53	1,03	57,4	240'
9	Eco Cotton (2): lightly soiled resistant and delicate colours.	40°	1400	●	●	9	53	1,10	97	225'
10	Cotton 20°C: lightly soiled resistant and delicate colours.	20°	1400	●	●	9	-	-	-	**
EXTRA										
11	Baby	40°	1000	●	●	5	-	-	-	**
12	Anti Allergy	60°	1400	●	●	5	-	-	-	**
13	Silk & Curtains: for garments in silk and viscose, lingerie.	30°	0	●	●	2	-	-	-	**
14	Duvets: for down-stuffed garments.	30°	1000	●	●	3,5	-	-	-	**
Partial Programmes										
	Rinse	-	1400	-	●	9	-	-	-	**
	Spin + Pump out	-	1400	-	-	9	-	-	-	**
	Pump out only *	-	OFF	-	-	9	-	-	-	**

* If you select programme and exclude the spin cycle, the machine will drain only.

** The duration of the wash cycle can be checked on the display.

The length of cycle shown on the display or in this booklet is an estimation only and is calculated assuming standard working conditions. The actual duration can vary according to factors such as water temperature and pressure, the amount of detergent used, the amount and type of load inserted, load balancing and any wash options selected.

1) Test wash cycle in compliance with regulations 1061/2010: set wash cycle 9 with a temperature of 60°C.

This cycle is designed for cotton loads with a normal soil level and is the most efficient in terms of both electricity and water consumption; it should be used for garments which can be washed at 60°C. The actual washing temperature may differ from the indicated value.

2) Test wash cycle in compliance with regulations 1061/2010: set wash cycle 9 with a temperature of 40°C.

This cycle is designed for cotton loads with a normal soil level and is the most efficient in terms of both electricity and water consumption; it should be used for garments which can be washed at 40°C. The actual washing temperature may differ from the indicated value.

For all Test Institutes:

2) Long wash cycle for cottons: set programme 9 at temperature 40°C.

3) Long wash cycle for synthetics: set wash cycle 4 with a temperature of 40°C.

Wash options

! If the selected option is not compatible with the set wash cycle, the indicator light will flash and the option will not be activated.

! If the selected option is not compatible with a previously selected one, the indicator light corresponding to the first function selected will flash and only the second option will be activated; the indicator light for the option which has been activated will be illuminated.

Steam Hygiene

This option enhances washing performance by generating steam during the wash cycle that eliminates any bacteria from fibres while treating them at the same time. Place the laundry in the drum, choose a compatible programme and select option .

! The steam generated during the operation of the washing machine may cause the porthole door to become hazy.

Time Saver

If you select this option, the wash cycle duration will be reduced by up to 50%, depending on the selected cycle, thereby guaranteeing simultaneous water and energy saving. Use this cycle for lightly soiled garments.

Detergents and laundry

GB

Detergent dispenser drawer

Successful washing results also depend on the correct dose of detergent: adding too much detergent will not necessarily result in a more efficient wash, and may in fact cause build up on the inside of your appliance and contribute to environmental pollution.

! Use powder detergent for white cotton garments, for pre-washing, and for washing at temperatures over 60°C.

! Follow the instructions given on the detergent packaging.

! Do not use hand washing detergents; they create too much foam.

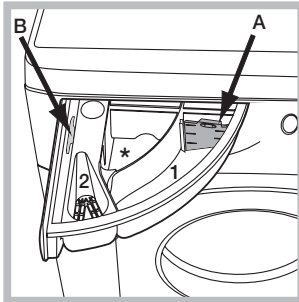

Open the detergent dispenser drawer and pour in the detergent or washing additive, as follows.

! Do not pour detergent into the middle compartment (*).

compartment 1: Detergent for the wash cycle (powder or liquid)

If liquid detergent is used,

it is recommended that the removable plastic partition **A** (supplied) be used for proper dosage. If powder detergent is used, place the partition into slot **B**.

compartment 2: Additives (fabric softeners, etc.)

The fabric softener should not overflow the grid.

Preparing the laundry

- Divide the laundry according to:
 - the type of fabric/the symbol on the label
 - the colours: separate coloured garments from whites.
- Empty all garment pockets and check the buttons.
- Do not exceed the listed values, which refer to the weight of the laundry when dry: see "Table of programmes and wash cycles".

How much does your laundry weigh?

- 1 sheet 400-500 g
- 1 pillow case 150-200 g
- 1 tablecloth 400-500 g
- 1 bathrobe 900-1,200 g
- 1 towel 150-250 g

Special wash cycles

Anti Stain: the programme **1** is suitable to heavily-soiled garments with resistant colours. It ensures a washing class that is higher than the standard class (A class). When running the programme, do not mix garments of different colours. We recommend the use of powder detergent. Pre-treatment with special additives is recommended if there are obstinate stains.

Anti Stain Quick: this programme is ideal for washing the most difficult daily stains in 1 hour. It is ideal for mixed fabrics and coloured garments, caring for your clothes as it washes.

Steam Refresh: this programme refreshes garments by removing bad odours and relaxing the fibres (1,5 kg, roughly 3 items). Insert dry items only (that are not dirty) and select programme **6**. The garments will be damp once the cycle is completed, so we recommend hanging them to dry. The **6** programme makes ironing easier.

! Not recommended for wool or silk garments.

! Do not add softeners or detergents.

Ultradelicates: use programme **7** to wash very delicate garments having strasses or sequins.

We recommend turning the garments inside out before washing and placing small items into the special bag

for washing delicates. Use liquid detergent on delicate garments for best results.

Wool - Woolmark Apparel Care - Green:

the wool wash cycle of this machine has been approved by The Woolmark Company for the washing of wool garments labelled as "hand wash" provided that the products are washed according to the instructions on the garment label and those issued by the manufacturer of this washing machine (M1127)



Cotton 20°C: the programme **10** ideal for lightly soiled cotton loads. The effective performance levels achieved at cold temperatures, which are comparable to washing at 40°, are guaranteed by a mechanical action which operates at varying speed, with repeated and frequent peaks.

Baby: use the special wash cycle **11** to remove the soiling typically caused by babies, while removing all traces of detergent from nappies in order to prevent the delicate skin of babies from suffering allergic reactions. The cycle has been designed to reduce the amount of bacteria by using a greater quantity of water and optimising the effect of special disinfecting additives added to the detergent.

Anti-Allergy: use programme **12** to remove major allergens such as pollen, mites, cat's and dog's hair.

Silk: use special wash cycle **13** to wash all silk garments. We recommend the use of special detergent which has been designed to wash delicate clothes.

Curains: fold curtains and place them in a pillow case or mesh bag. Use wash cycle **13**.

Duvets: to wash double or single duvets (the weight of which should not exceed 3,5 kg), cushions or clothes padded with goose down such as puffer jackets, use the special **14** wash cycle. We recommend that duvets are placed in the drum with their edges folded inwards (see figure) and that no more than $\frac{3}{4}$ of the total volume of the drum is used. To achieve the best results, we recommend that a liquid detergent is used and placed inside the detergent dispenser drawer.

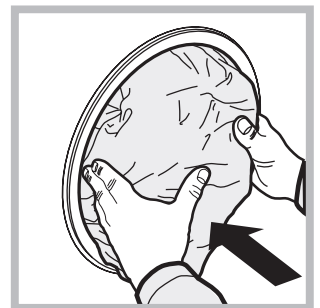

Load balancing system

Before every spin cycle, to avoid excessive vibrations before every spin and to distribute the load in a uniform manner, the drum rotates continuously at a speed which is slightly greater than the washing rotation speed. If, after several attempts, the load is not balanced correctly, the machine spins at a reduced spin speed. If the load is excessively unbalanced, the washing machine performs the distribution process instead of spinning. To encourage improved load distribution and balance, we recommend small and large garments are mixed in the load.

Your washing machine could occasionally fail to work. Before contacting the Technical Assistance Service (see “Service”), make sure that the problem cannot be solved easily using the following list.

Problem:	Possible causes / Solutions:
The washing machine does not switch on.	<ul style="list-style-type: none">• The appliance is not plugged into the socket fully, or not enough to make contact.• There is no power in the house.
The wash cycle does not start.	<ul style="list-style-type: none">• The washing machine door is not closed properly.• The ON/OFF button has not been pressed.• The START/PAUSE button has not been pressed.• The water tap has not been opened.• A delayed start has been set.
The washing machine does not fill with water (the text “H2O” flashes on the display).	<ul style="list-style-type: none">• The water inlet hose is not connected to the tap.• The hose is bent.• The water tap has not been opened.• There is no water supply in the house.• The pressure is too low.• The START/PAUSE button has not been pressed.
The washing machine continuously takes in and drains water.	<ul style="list-style-type: none">• The drain hose is not fitted at a height between 65 and 100 cm from the floor (see “Installation”).• The free end of the hose is under water (see “Installation”).• The wall drainage system is not fitted with a breather pipe. <p>If the problem persists even after these checks, turn off the water tap, switch the appliance off and contact the Technical Assistance Service. If the dwelling is on one of the upper floors of a building, there may be problems relating to water drainage, causing the washing machine to fill with water and drain continuously. Special anti-draining valves are available in shops and help to prevent this inconvenience.</p>
The washing machine does not drain or spin.	<ul style="list-style-type: none">• The wash cycle does not include draining: some cycles require the draining process to be enabled manually.• The drain hose is bent (see “Installation”).• The drainage duct is clogged.
The washing machine vibrates a lot during the spin cycle.	<ul style="list-style-type: none">• The drum was not unlocked correctly during installation (see “Installation”).• The washing machine is not level (see “Installation”).• The washing machine is trapped between cabinets and walls (see “Installation”).
The washing machine leaks.	<ul style="list-style-type: none">• The water inlet hose is not screwed on properly (see “Installation”).• The detergent dispenser drawer is blocked (for cleaning instructions, see “Care and maintenance”).• The drain hose is not fixed properly (see “Installation”).
The “option” and START/PAUSE indicator lights flash rapidly and an error code appears on the display (e.g.: F-01, F-..).	<ul style="list-style-type: none">• Switch off the machine and unplug it, wait for approximately 1 minute and then switch it back on again. <p>If the problem persists, contact the Technical Assistance Service.</p>
There is too much foam.	<ul style="list-style-type: none">• The detergent is not suitable for machine washing (it should display the text “for washing machines” or “hand and machine wash”, or the like).• Too much detergent was used.

Service

GB

Before contacting the Technical Assistance Service:

- Check whether you can solve the problem alone (see "Troubleshooting");
- Restart the wash cycle to check whether the problem has been solved;
- If this is not the case, contact an authorised Technical Assistance Centre.

! Always request the assistance of authorised technicians.

Have the following information to hand:

- the type of problem;
- the appliance model (Mod.);
- the serial number (S/N).

This information can be found on the data plate applied to the rear of the washing machine, and can also be found on the front of the appliance by opening the door.

COMMISSION DELEGATED REGULATION (EU) No 1061/2010	
Brand	ARISTON
Model	RPG 9447 SX EX
Rated capacity in kg of cotton	9
Energy efficiency class on a scale from A+++ (low consumption) to G (high consumption)	A+++
Energy consumption per year in kWh ¹⁾	196
Energy consumption of the standard 60 °C cotton programme at full load in kWh ²⁾	1.034
Energy consumption of the standard 60 °C cotton programme at partial load in kWh ²⁾	0.782
Energy consumption of the standard 40 °C cotton programme at partial load in kWh ²⁾	0.706
Power consumption of the off-mode in W	0.5
Power consumption of the left-on mode in W	8
Water consumption per year in litres ³⁾	11690
Spin-drying efficacy class on a scale from G (minimum efficacy) to A (maximum efficacy)	B
Maximum spin speed attained ⁴⁾	1400
Remaining moisture content ⁵⁾	53.0%
Programme time of the "standard 60 °C cotton" at full load in minutes	240
Programme time of the "standard 60 °C cotton" at partial load in minutes	180
Programme time of the "standard 40°C cotton" at partial load in minutes	175
Duration of the left-on mode in minutes	30
Noise in dB(A) re 1 pW washing ⁶⁾	54
Noise in dB(A) re 1 pW spinning ⁶⁾	83
Built-in model	

¹⁾ The "standard 60°C cotton" at full and partial load and the "standard 40°C cotton" at partial load are the standard washing programmes to which the information in the label and the fiche relates. Standard 60°C cotton and standard 40°C cotton are suitable to clean normally soiled cotton laundry and are the most efficient programmes in terms of combined energy and water consumption. Partial load is half the rated load.

²⁾ Based on 220 standard washing cycles for cotton programmes at 60°C and 40°C at full and partial load, and the consumption of the low-power modes. Actual energy consumption will depend on how the appliance is used.

³⁾ Based on 220 standard washing cycles for cotton programmes at 60°C and 40°C at full and partial load. Actual water consumption will depend on how the appliance is used.

⁴⁾ For the standard 60 °C at full and partial load or the 40°C at partial whichever is lower.

⁵⁾ Attained for 60 °C cotton at full and partial load or the 40°C at partial whichever is higher.

⁶⁾ Based on washing and spinning phases for the standard 60°C cotton programme at full load.