

Instructions for installation and use

WASHER-DRYER

EN

EN

English, 1

AR

عربي, 15

AQUALTIS

AQD1170D 49 60HZ

 This symbol reminds you to read this instruction manual.

Contents

Installation, 2-3-4

Unpacking and levelling
Connecting the electricity and water supplies
Technical data

Assistance, 5

Care and maintenance, 6

Cutting off the water and electricity supplies
Cleaning the machine
Cleaning the detergent dispenser drawer
Caring for your appliance drum
Cleaning the pump
Checking the water inlet hose

Precautions and advice, 7

General safety
Disposal

Description of the machine, 8-9

Touch control panel

How to run a wash cycle or a drying cycle, 10

Wash cycles and options, 11

Table of wash cycles
Wash options

Detergents and laundry, 12

Detergent
Preparing the laundry
Washing recommendations
Load balancing system

Trouble shooting, 13

Instruction Sheet, 14



ARISTON

Installation

EN

! This instruction manual should be kept in a safe place for future reference. If the Washer-dryer is sold, given away or moved, please ensure the manual is kept with the machine, so that the new owner may benefit from the advice contained within it.

! Read these instructions carefully: they contain vital information relating to the safe installation and operation of the appliance.

! Inside the pack containing this manual, you will also find the guarantee and all the details necessary for installation.

Unpacking and levelling

Unpacking

1. Once you have removed all the packaging from the Washer-dryer, make sure it has not been damaged during transportation. If it has been damaged, contact the retailer and do not proceed any further with the installation process.

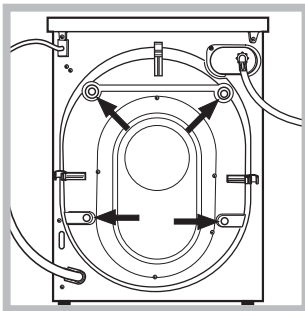

2. Remove the 4 protective screws (used during transportation) and the corresponding spacer, located on the rear part of the appliance (see figure).

3. Close off the holes using the plastic plugs supplied in the pack.

4. Keep all the parts in a safe place; they will be needed again if the Washer-dryer is moved to another location, to prevent the inside of the appliance being damaged.

! Packaging materials should not be used as toys for children.

Levelling

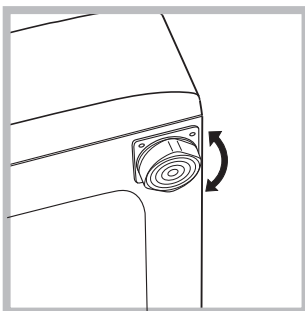

1. Place the Washer-dryer on a flat sturdy floor, without resting it up against walls or cabinets.

2. If the floor is uneven, the front feet of the machine may be adjusted until it reaches a horizontal position (the angle of inclination must not exceed 2 degrees).

! If the appliance is levelled correctly, it will be more stable and much less likely to cause vibrations and noise while it is operating, particularly during the spin cycle.

! If it is placed on carpet or a rug, adjust the feet in such a way as to allow a sufficient ventilation space underneath the Washer-dryer.

Connecting the electricity and water supplies

Connecting the water inlet hose

! Before connecting the inlet hose to the water supply, run the water until it is perfectly clear.

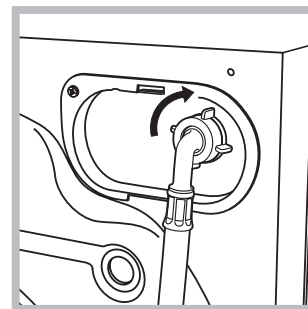

1. Connect the inlet hose to the machine by screwing it onto the cold water inlet of the appliance, which is situated on the top right-hand side of the rear part of the appliance (see figure).

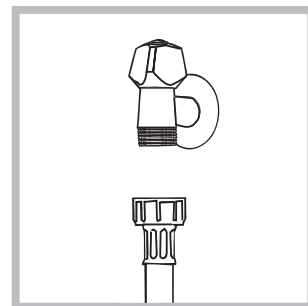

2. Connect the inlet hose by screwing it to a cold water tap using a 3/4 threaded connection (see figure).

3. Make sure that the hose is not folded over or bent.

! The water pressure at the tap must fall within the values indicated in the Technical data table (see next page).

! If the inlet hose is not long enough, contact a specialised shop or an authorised technician.

! Never use second-hand or old inlet hoses; use the products supplied with the machine.

Connecting the drain hose

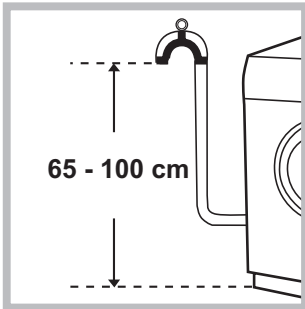

Connect the drain hose, without bending it, to a drainage duct or a wall drain located at a height between 65 and 100 cm from the floor;

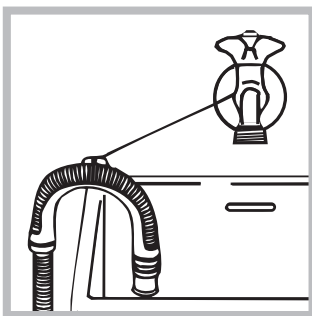

Alternatively, place the drain hose over the edge of a washbasin or bathtub, by fastening the guide (which can be purchased at the technical assistance centre) to the tap (see figure). The free end of the

hose should not be underwater.

! We advise against the use of hose extensions; if it is absolutely necessary, the extension must have the same diameter as the original hose and must not exceed 150 cm in length.

Electric connection

Before plugging the appliance into the mains socket, make sure that:

- the socket is earthed and in compliance with the applicable law;
- the socket is able to sustain the appliance's maximum power load indicated on the Technical Data Plate fixed on the machine;
- the supply voltage is included within the values indicated on the Technical Data Plate fixed on the machine.
- the socket is compatible with the washing machine's plug. If this is not the case, replace the socket or the plug.

Your appliance is now supplied with a 13 amp fused plug it can be plugged into a 13 amp socket for immediate use. Before using the appliance please read the instructions below.

WARNING - THIS APPLIANCE MUST BE EARTHED.

THE FOLLOWING OPERATIONS SHOULD BE CARRIED OUT BY A QUALIFIED ELECTRICIAN.

Replacing the fuse:

When replacing a faulty fuse, a 13 amp ASTA approved fuse to BS 1362 should always be used, and the fuse cover re-fitted. If the fuse cover is lost, the plug must not be used until a replacement is obtained.

Replacement fuse covers:

If a replacement fuse cover is fitted, it must be of the correct colour as indicated by the coloured marking or the colour that is embossed in words on the base of the plug. Replacements can be obtained directly from your nearest Service Depot.

Removing the plug:

If your appliance has a non-rewireable moulded plug and you should wish to re-route the mains cable through partitions, units etc., please ensure that either: the plug is replaced by a fused 13 ampere rewireable plug bearing the BSI mark of approval.

or:

the mains cable is wired directly into a 13 amp cable outlet, controlled by a switch, (in compliance with BS 5733) which is accessible without moving the appliance.

Disposing of the plug:

Ensure that before disposing of the plug itself, you make the pins unusable so that it cannot be accidentally inserted into a socket.

Instructions for connecting cable to an alternative plug:

Important: the wires in the mains lead are coloured in accordance with the following code:

Green & Yellow	Earth
Blue	Neutral
Brown	Live

Before calling for Assistance:

- Check whether you can solve the problem by yourself (see “*Trouble shooting*”);
- Restart the wash cycle to check whether the problem has been solved;
- If it has not, contact the Authorised Technical Assistance Service.

! If the Washer-dryer has been installed or used incorrectly, you will have to pay for the call-out service.

! Always request the assistance of authorised technicians.

Please have the following information to hand:

- the type of problem;
- the appliance model (Mod.);
- the serial number (S/N).

The above information can be found on the data plate located on the appliance itself.

! Note: to exit “Demo mode”, switch machine off, press and hold the two “START/PAUSE” >|| and “ON/OFF” ⏻ buttons simultaneously for 3 seconds.

Care and maintenance

EN

Cutting off the water and electricity supplies

- Turn off the water tap after every wash cycle. This will limit wear on the hydraulic system in the machine and help to prevent leaks.
- Unplug the appliance when cleaning it and during all maintenance work.

Cleaning the machine

The outer parts and rubber components of the appliance can be cleaned using a soft cloth soaked in lukewarm soapy water. Do not use solvents or abrasives.

Cleaning the detergent dispenser drawer

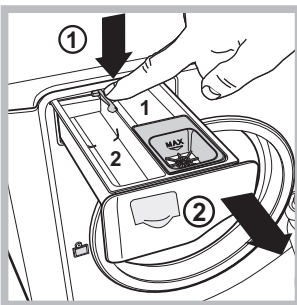

To remove the drawer, press lever (1) and pull the drawer outwards (2) (see figure). Wash it under running water; this procedure should be repeated frequently.

Caring for your appliance drum

- Always leave the door ajar to prevent unpleasant odours from forming.

Cleaning the pump

The Washer-dryer is fitted with a self-cleaning pump which does not require any maintenance. Sometimes, small items (such as coins or buttons) may fall into the protective pre-chamber at the base of the pump.

! Make sure the wash cycle has finished and unplug the appliance.

To access the pre-chamber:

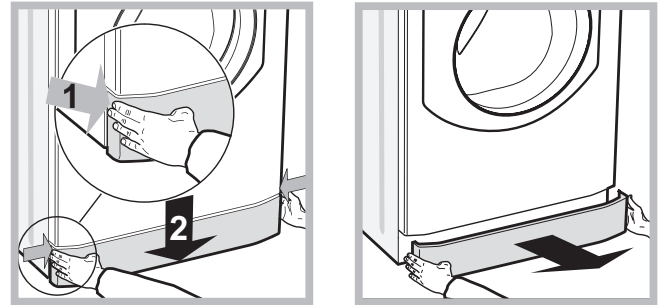

1. take off the cover panel on the front of the machine by first pressing it in the centre and then pushing downwards on both sides until you can remove it (see figures);

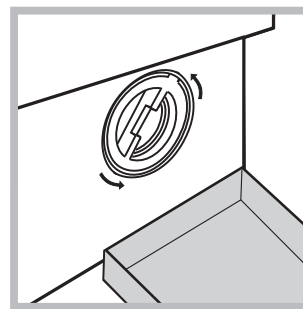

2. position a container so that it will collect the water which flows out (approximately 1.5 l) (see figure);
3. unscrew the lid by rotating it in an anti-clockwise direction (see figure);

4. clean the inside thoroughly;
5. screw the lid back on;
6. reposition the panel, making sure the hooks are securely in place before you push it onto the appliance.

Checking the water inlet hose

Check the inlet hose at least once a year. If there are any cracks, it should be replaced immediately: during the wash cycles, water pressure is very strong and a cracked hose could easily split open.

! The machine was designed and constructed in accordance with international safety regulations. The following information is provided for safety reasons and must therefore be read carefully.

General safety

- This appliance was designed for domestic use only.
 - This appliance can be used by children aged from 8 years and above and persons with reduced physical, sensory or mental capabilities or lack of experience and knowledge if they have been given supervision or instruction concerning use of the appliance in a safe way and understand the hazards involved. Children shall not play with the appliance. Cleaning and user maintenance shall not be made by children without supervision.
 - Do not dry unwashed items in the tumble dryer.
 - Items that have been soiled with substances such as cooking oil, acetone, alcohol, petrol, kerosene, spot removers, turpentine, waxes and wax removers should be washed in hot water with an extra amount of detergent before being dried in the tumble dryer.
 - Items such as foam rubber (latex foam), shower caps, waterproof textiles, rubber backed articles and clothes or pillows fitted with foam rubber pads should not be dried in the tumble dryer.
 - Fabric softeners, or similar products, should be used as specified by the fabric softener instructions.
 - The final part of a tumble dryer cycle occurs without heat (cool down cycle) to ensure that the items are left at a temperature that ensures that the items will not be damaged.
- WARNING:** Never stop a tumble dryer before the end of the drying cycle unless all items are quickly removed and spread out so that the heat is dissipated.
- Do not touch the machine when barefoot or with wet or damp hands or feet.
 - Do not pull on the power supply cable when unplugging the appliance from the electricity socket. Hold the plug and pull.
 - Do not touch the drained water as it may reach extremely high temperatures.
 - Never force the porthole door. This could damage the safety lock mechanism designed to prevent accidental opening.
 - If the appliance breaks down, do not under any circumstances access the internal mechanisms in an attempt to repair it yourself.
 - Always keep children well away from the appliance while it is operating.
 - If it must be moved, proceed with the help of two or three people and handle it with the utmost care. Never try to do this alone, because the appliance is very heavy.
 - Before loading laundry into the washer dryer, make sure the drum is empty.
 - During the drying phase, the door tends to get quite hot.
 - Do not use the appliance to dry clothes that have been washed with flammable solvents (e.g. trichlorethylene).

- Do not use the appliance to dry foam rubber or similar elastomers.
- Make sure that the water tap is turned on during the drying cycles.
- Children of less than 3 years should be kept away from the appliance unless continuously supervised.
- Remove all objects from pockets such as lighters and matches.
- This machine must not be operated in a non air-conditioned environment.

Disposal

- Disposing of the packaging materials: observe local regulations so that the packaging may be re-used.
- The European Directive 2012/19/EU relating to Waste Electrical and Electronic Equipment (WEEE) states that household appliances should not be disposed of using the normal solid urban waste cycle. Exhausted appliances should be collected separately in order to optimise the cost of re-using and recycling the materials inside the machine, while preventing potential damage to the atmosphere and to public health. The crossed-out dustbin is marked on all products to remind the owner of their obligations regarding separated waste collection. For more information relating to the correct disposal of household appliances, owners should contact their local authorities or appliance dealer.

Description of the machine

EN



PORTHOLE DOOR



Always use the handle to open the porthole door (see figure).

TOUCH CONTROL PANEL

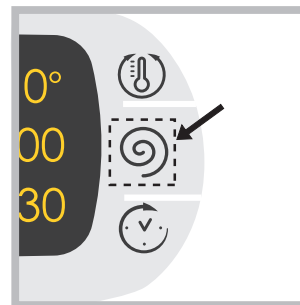

To adjust the settings, gently press the icon inside the sensitive (touch control) area as illustrated in the figure.

DETERGENT DISPENSER DRAWER



The detergent dispenser drawer is located inside the machine and can be accessed by opening the door.

For more information on detergent measures, please refer to the chapter entitled "Detergents and laundry".

Standby mode

This Washer-dryer, in compliance with new energy saving regulations, is fitted with an automatic standby system which is enabled after about 30 minutes if no activity is detected. Press the ON-OFF  button briefly and wait for the machine to start up again.

Consumption in off-mode: 0,5 W

Consumption in Left-on: 8 W

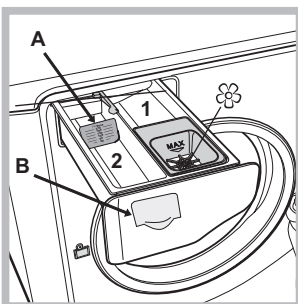

1. *pre-wash compartment*: use powder detergent.
2. *main wash compartment*: If liquid detergent is used, it is recommended that the removable plastic partition **A** (supplied) be used for proper dosage. If powder detergent is used, place the partition into slot **B**.

 *washing additives compartment*: for fabric softener or liquid additives. We recommend that the maximum level indicated by the grille is not exceeded, and that concentrated fabric softeners are diluted.

Touch control panel

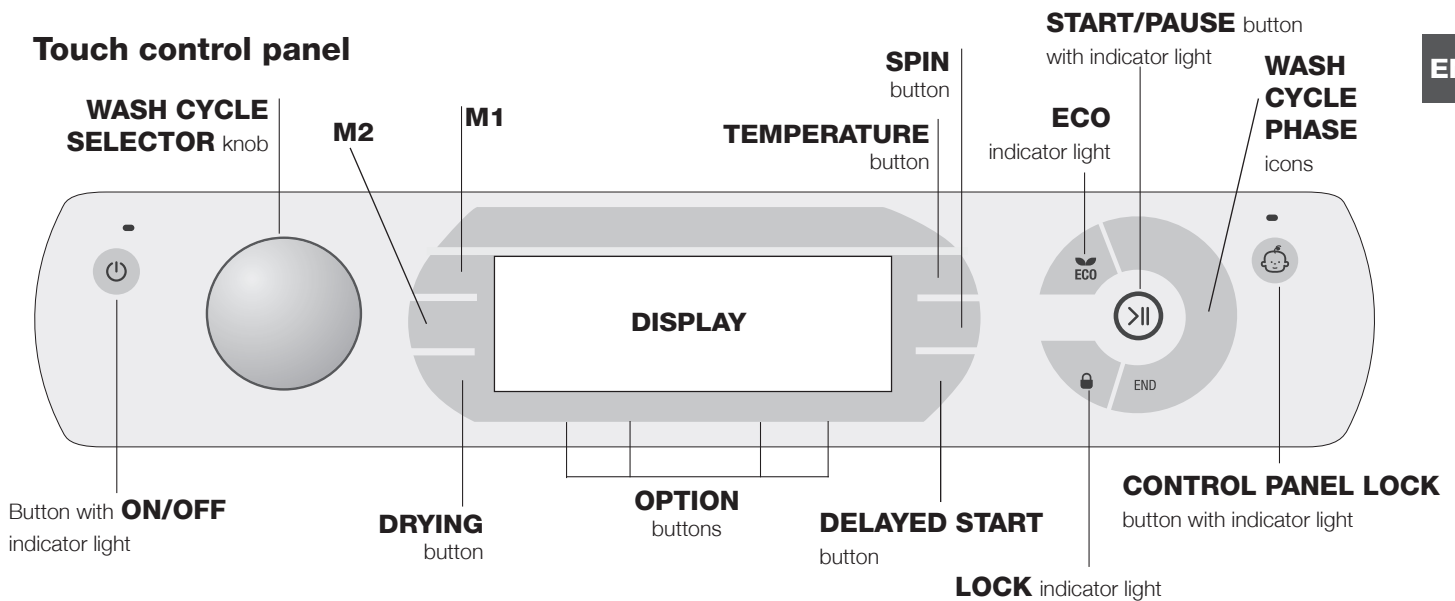

Button with **ON/OFF** indicator light: press this briefly to switch the machine on or off. The green indicator light indicates that the machine is switched on. To switch off the Washer-dryer during the wash cycle, press and hold the button for approximately 3 seconds; if the button is pressed briefly or accidentally the machine will not switch off. If the machine is switched off during a wash cycle, this wash cycle will be cancelled.

WASH CYCLE SELECTOR knob: may be turned in either direction. To select the most suitable wash cycle, please refer to the "Table of wash cycles". The knob will not move during the wash cycle.

M1-M2 buttons: press and hold one of the buttons to store a cycle with your own set preferences in the memory of the machine. To recall a previously-stored cycle, press the corresponding button.

DRYING button : press to decrease or exclude drying; the selected drying level or time will appear on the display (see "How to run a wash cycle or a drying cycle").

TEMPERATURE button: press to modify or exclude the temperature setting; the value selected will appear on the display above (see "How to run a wash cycle or a drying cycle").

SPIN CYCLE button: press to modify or exclude the spin cycle; the value selected will appear on the display above (see "How to run a wash cycle or a drying cycle").

DELAYED START button: press to set a delayed start for the selected wash cycle; the set delay time will appear on the display above (see "How to run a wash cycle or a drying cycle").

OPTION buttons: press to select the available options. The indicator light corresponding to the selected option will remain lit (see "How to run a wash cycle or a drying cycle").

WASH CYCLE PHASE icons: these illuminate to indicate the progress of the wash cycle (Wash – Rinse – Spin/Drain – Drying). The text **END** lights up when the cycle is complete.

START/PAUSE button with indicator light: when the green indicator light flashes slowly, press the button to start a wash cycle. Once the cycle has begun the indicator light will remain

lit in a fixed manner. To pause the wash cycle, press the button again; the indicator light will flash in an orange colour. If the "LOCK" indicator light is switched off, the door may be opened. To start the wash cycle from the point at which it was interrupted, press the button again.

LOCK indicator light: indicates that the porthole door is locked. To open the door, pause the wash cycle (see "How to run a wash cycle or a drying cycle").

CONTROL PANEL LOCK button with indicator light: to activate or deactivate the control panel lock, press and hold the button for approximately 2 seconds. when the indicator light is illuminated, the control panel is locked (apart from the ON/OFF button). This means it is possible to prevent wash cycles from being modified accidentally, especially where there are children in the home.

ECO indicator light: the **ECO** icon lights up when, after altering the washing parameters, an energy saving of at least 10% is made. Furthermore, before the machine enters "Standby" mode, the icon will light up for a few seconds; when the machine is switched off the estimated energy saving will be around the 80% mark.



CHANGE LANGUAGE The first time the machine is switched on, the first language will flash on the display. The "Λ", "OK" and "V" symbols will appear on the display, in line with the 3 buttons on the right-hand side. The languages change automatically every 3"; alternatively, they can be changed by pressing the buttons next to the "Λ" and "V" symbols. Use the "OK" button to confirm the language, which will be set after 2". If no buttons are pressed, the automatic language change will begin again after 30".

To change the language, switch the machine on and off again; in the 30" time period after it has been switched off, press and hold the temperature + spin + delayed start buttons simultaneously for 5". A short sound alert will be emitted and the set language will flash on the display. Press the buttons next to the "Λ" and "V" symbols to change the language. Use the button next to the "OK" symbol to confirm the language, which will be set after 2". If no buttons are pressed, the language set previously will be displayed after 30". **Switch on the machine.**



How to run a wash cycle or a drying cycle

EN

WARNING: before you use the Washer-dryer for the first time, run a wash cycle with detergent and no laundry, using the 90° cottons cycle without pre-wash.

1. **SWITCH THE MACHINE ON.** Press the  button. All the indicator lights will illuminate for 1 second and the text AQUALTIS will appear on the display; the indicator light corresponding to the  button will then remain lit in a constant manner and the START/PAUSE indicator light will flash.
2. **SELECT THE PROGRAMME.** Turn the PROGRAMME KNOB left or right, until the required programme has been selected; the name of the programme will appear on the display. A temperature and spin speed is set for each programme; these may be adjusted. The cycle duration will also appear on the display.
3. **LOAD THE LAUNDRY.** Open the porthole door. Load the laundry, making sure you do not exceed the maximum load value indicated in the *table of wash cycles on the following page*.
4. **MEASURE OUT THE DETERGENT.** Pull out the detergent dispenser drawer and pour the detergent into the relevant compartments as described in *"Description of the machine"*.
5. **CLOSE THE PORTHOLE DOOR.**
6. **CUSTOMISE THE WASH CYCLE.** Use the relevant buttons on the control panel:

Modify the temperature and/or spin speed.

The machine automatically displays the maximum temperature and spin speed values set for the selected cycle, or the most recently-used settings if they are compatible with the selected cycle. The temperature can be decreased by pressing the  button, until the cold wash "OFF" setting is reached. The spin speed may be progressively reduced by pressing the  button, until it is completely excluded "OFF". If these buttons are pressed again, the maximum values are restored.

! Exception: if the  programme is selected, the temperature can be increased up to a value of 90°C.

Setting the drying cycle.

The first time the button  is pressed, the machine will automatically select the maximum drying cycle which is compatible with the selected wash cycle. Subsequent presses will decrease the drying level and then the drying time, until the cycle is excluded completely ("OFF"). If these buttons are pressed again, the maximum values are restored.

Drying may be set as follows:

A - Based on a set time period: between **30** and **180** minutes.

B - Based on the desired laundry dryness level:

Iron: suitable for clothes which will need ironing afterwards. the remaining dampness softens creases, making them easier to remove.

Hanger: ideal for clothes which do not need to be dried fully.

Cupboard: suitable for laundry which can be put back in a cupboard without being ironed.



Extra: suitable for garments which need to be dried completely, such as sponges and bathrobes.

If your laundry load to be washed and dried is much greater than the maximum stated load, perform the wash cycle, and when the cycle is complete, divide the garments into groups and put some of them back in the drum. At this point, follow the instructions provided for a **"Drying only"** cycle. Repeat this procedure for the remainder of the load. A cooling-down period is always added to the end of each drying cycle.

Drying only

Use the cycle selector knob to select a drying cycle () in accordance with the type of fabric. The desired drying level or time may also be set using the DRYING button .

Setting a delayed start.

To set a delayed start for the selected cycle, press the corresponding button repeatedly until the required delay period has been reached. During the setting procedure, the delay period and the text "Starts in:" will be displayed, along with the flashing  symbol. After the delayed start has been set, the  symbol will remain fixed on the display, which will also indicate the duration of the selected cycle with the text "Ends in:" and the cycle duration. Press the DELAYED START button just once to display the delay time set previously. After the countdown has begun, the display will show the text "Starts in:" and the delay period. Once the set delay time has elapsed, the machine will begin its cycle and the display will show "Ends in:" and the time remaining until the end of the cycle. To remove the delayed start option, press the button until the display shows the text OFF; the  symbol will disappear.



Modify the cycle settings.

- Press the button to activate the option; the name of the option will then appear on the display and the corresponding indicator light will illuminate.
- Press the button again to deactivate the option; the name of the option will then appear on the display followed by the text OFF, and the corresponding indicator light will switch off.

! If the selected option is not compatible with the selected wash cycle, this incompatibility will be signalled by the flashing of the indicator light and a sound alert (3 beeps); the option will not be activated.

! If the selected option is not compatible with another option that has been selected previously, the indicator light corresponding to the first option selected will flash and only the second option will be activated; the indicator light corresponding to the button will remain lit in a constant manner.

! The options may affect the recommended load value and/or the duration of the cycle.

7. **START THE PROGRAMME.** Press the START/PAUSE button. The corresponding indicator light remains lit in a fixed manner and the porthole door locks (the  LOCK indicator light illuminates). The icons corresponding to the wash cycle phases will light up during the cycle to indicate which phase is currently in progress. To change a wash cycle once it has already started, pause the Washer-dryer by pressing the START/PAUSE button; then select the desired cycle and press the START/PAUSE button again. To open the door during a wash cycle, press the START/PAUSE button; if the LOCK  indicator light is switched off you may open the door. Press the START/PAUSE button again to restart the wash cycle from the point at which it was interrupted.
8. **THE END OF THE WASH CYCLE.** This is indicated by the illuminated text **END**. The porthole door may be opened immediately. If the START/PAUSE indicator light is flashing, press the button to end the cycle. Open the door, unload the laundry and switch off the machine.

! If you wish to cancel a cycle which has already begun, press and hold the  button until the cycle stops and the machine switches off.

Table of wash cycles

Icon	Description of the wash cycle	Max. temp. (°C)	Max. speed (rpm)	Drying	Detergent and additives			Max. load (kg)	Cycle duration
					Pre-wash	Wash	Fabric softener		
	Cotton Coloureds (2): lightly soiled whites and delicate colours.	40°	1400	●	-	●	●	11	(*) The duration of the wash cycles can be checked on the display.
	Synthetics Resistant	60°	1200	●	-	●	●	5	
	Whites	60°	1400	●	-	●	●	6	
	Coloureds	40°	1400	●	-	●	●	6	
	Darks	30°	800	●	-	●	●	6	
	Wool Platinum Care: for wool, cashmere, etc.	40°	800	●	-	●	●	2,5	
	Ultradelicates	30°	0	●	-	●	●	1	
	Anti Allergy	60°	1400	●	-	●	●	6	
	Rinse	-	1400	●	-	-	●	11	
	Spin and Pump out	-	1400	●	-	-	-	11	
	Wash&Dry	30°	1400	●	-	●	●	1	
	Drying Cottons	-	-	●	-	-	-	7	
	Drying Wool	-	-	●	-	-	-	2,5	
	Drying Synthetics	-	-	●	-	-	-	5	
	Cotton Hygiene Prewash (Add detergent to the relevant compartment).	90°	1400	●	●	●	●	11	
	Cotton Whites (1): heavily soiled whites and resistant colours.	60° (Max. 90°C)	1400	●	-	●	●	11	

The length of cycle shown on the display or in this booklet is an estimation only and is calculated assuming standard working conditions. The actual duration can vary according to factors such as water temperature and pressure, the amount of detergent used, the amount and type of load inserted, load balancing and any wash options selected.

(*) Note: 10 minutes after the START, the machine will recalculate the time remaining until the end of the wash cycle on the basis of the load inside it; this value will then be shown on the display.

For all Test Institutes:

- 1) Test Programmes according to SASO 2885:2018: set wash cycle with a temperature of 60°C for Cotton Standard 60°C.
- 2) Test Programmes according to SASO 2885:2018: set wash cycle with a temperature of 40°C for Cotton Standard 40°C.

Wash options

! If the selected option is not compatible with the selected wash cycle, this incompatibility will be signalled by the flashing of the indicator light and a sound alert (3 beeps); the option will not be activated.

! If the selected option is not compatible with another option that has been selected previously, the indicator light corresponding to the first option selected will flash and only the second option will be activated; the indicator light corresponding to the button will remain lit in a constant manner.

Super Wash

This option offers a high-performance wash due to the greater quantity of water used in the initial phase of the cycle, and due to the increased wash cycle duration, is particularly useful for the removal of stubborn stains.

Extra rinse

By selecting this option, the efficiency of the rinse is increased and optimal residual detergent removal is guaranteed. It is particularly useful for skin which is sensitive to detergents. We recommend this option is used with a full load of washing, or when a large amount of detergent is required.

Easy Iron

By selecting this option, the wash and spin cycles will be modified in order to reduce the formation of creases.

Note: If you also want to run the drying cycle, this option is enabled only if combined with level "Iron".

Time Saver

If you select this option, the wash cycle duration will be reduced by up to 50%, depending on the selected cycle, thereby guaranteeing simultaneous water and energy saving. Use this cycle for lightly soiled garments.

Data referred to SASO 2885/2018 Standard cycles

Phase	Info	Standard Cotton 60°C Full load	Standard Cotton 60°C Half load	Standard Cotton 40°C half load
Washing phase	Number	1	1	1
	Time (min)	295	180	180
	Water (L)	23,5	17,2	17
Rinse phase	Number	2	2	2
	Time (min) rinse 1	14	9	10
	Water (L) rinse 1	15	12,5	12,5
	Time (min) rinse 2	12	9	10
	Water (L) rinse 2	14	14	12,8
Spin phase	Number	3	3	3
	Time (min) spin 1	14	15	15
	Time (min) spin 2	14	13	13
	Time (min) spin 3	38	38	38

Detergents and laundry

EN

Detergent

The type and quantity of detergent required depend on the type of fabric you are washing (cotton, wool, silk, etc.), as well as its colour, the washing temperature, the level of soiling and the hardness of the water in the area.

Measuring out the detergent carefully will avoid wastage and help to protect the environment: although they are biodegradable, detergents still contain ingredients which alter the balance of nature.

We recommend the following:

- use powder detergents for white cotton garments and pre-washing.
- use liquid detergents for delicate cotton garments and for all low-temperature wash cycles.
- use gentle liquid detergents for wool and silk garments.

The detergent should be poured into the relevant compartment - or the dispenser placed directly inside the drum - before the wash cycle begins. In the latter case, it will not be possible to select the Cottons with pre-wash cycle.

! Do not use hand washing detergents because these create too much foam.

Preparing the laundry

- Shake out the garments before loading them into the machine.
- Divide the laundry according fabric type (symbol on the washing instruction label) and colour, making sure you separate the coloured garments from the white ones;
- Empty all pockets and check the buttons;
- Do not exceed the values listed in the "Table of wash cycles", which refer to the weight of the laundry when dry.

How much does your laundry weigh?

1 sheet	400-500 g
1 pillowcase	150-200 g
1 tablecloth	400-500 g
1 bathrobe	900-1200 g
1 towel	150-250 g
1 pair of jeans	400-500 g
1 shirt	150-200 g

Washing recommendations

Whites: use this cycle  to wash white clothes. The programme is designed to maintain the brightness of white clothes over time.

If the drying function is selected, a drying cycle automatically activates at the end of the wash cycle that resembles open-air drying, with the added advantages of preserving garments from yellowing due to sunlight exposure and preventing loss of whiteness caused by the possible presence of dust in the air. Drying cycles can only be selected on a level basis.

Coloureds: use this cycle  to wash bright coloured clothes. The programme is designed to maintain bright colours over time.

Darks: Use cycle  to wash dark-coloured garments. This programme is designed to maintain dark colours over time. We recommend using a liquid detergent for the best results when washing dark-coloured garments.

When you select the drying function, at the end of the washing cycle the machine will automatically perform a delicate drying cycle that preserves the colours of the garments. The display will show the level "Iron". Max. load: 3 kg.

Wool - Wool Care:

The wool wash cycle of this machine has been approved by The Woolmark Company for the washing of machine washable wool products provided that the products are washed according to the instructions on the garment label and those issued by the manufacturer of this washing machine. The Woolmark symbol is a Certification mark in many countries. (M2222)



Ultradelicates: use programme  to wash very delicate garments having strasses or sequins. We recommend turning the garments inside out before washing and placing small items into the special bag for washing delicates. Use liquid detergent on delicate garments for best results.

When selecting an exclusively time-based drying function, a drying cycle is performed at the end of the wash cycle that is particularly delicate, thanks to light handling and appropriate temperature control of the water jet.





The recommended durations are:

1 kg of synthetic garments --> 160 min

1 kg of synthetic and cotton garments --> 180 min

1 kg of cotton garments --> 180 min

The degree of dryness depends on the load and fabric composition.

To wash **Silk** garments and **Curtains** select cycle  and then option ; the machine will end the cycle while the laundry is soaking and the  indicator light will flash. To drain the water so that the laundry may be removed, press the START/PAUSE button or the  button.

Anti Allergy: use programme  to remove major allergens such as pollen, mites, cat's and dog's hair.

Wash&Dry: select programme  for washing and drying lightly soiled garments (Cotton and Synthetic) in a short time. This cycle may be used to wash and dry a laundry load of up to 1 kg in just 45 minutes. To achieve optimum results, use liquid detergent and pre-treat cuffs, collars and stains.

Stubborn stains: it is wise to treat stubborn stains with solid soap before washing, and to use the Cottons with pre-wash cycle.

Load balancing system

Before every spin cycle, to avoid excessive vibrations before every spin and to distribute the load in a uniform manner, the drum rotates continuously at a speed which is slightly greater than the washing rotation speed. If, after several attempts, the load is not balanced correctly, the machine spins at a reduced spin speed. If the load is excessively unbalanced, the Washer-dryer performs the distribution process instead of spinning. To encourage improved load distribution and balance, we recommend small and large garments are mixed in the load.

Your Washer-dryer could occasionally fail to work. Before contacting the Technical Assistance Centre (see “Assistance”), make sure that the problem cannot be solved easily using the following list.

Problem:

Possible causes / Solutions:

The Washer-dryer does not switch on.

- The appliance is not plugged into the socket fully, or not enough to make contact.
- There is no power in the house.

The wash cycle does not start.

- The door is not closed properly.
- The START/PAUSE button has not been pressed.
- The water tap has not been opened.
- A delayed start has been set.

The Washer-dryer does not fill with water.

- The water inlet hose is not connected to the tap.
- The hose is bent.
- The water tap has not been opened.
- There is no water supply in the house.
- The pressure is too low.
- The START/PAUSE button has not been pressed.

The machine continuously fills with water and drains.

- The drain hose is not fitted at a height between 65 and 100 cm from the floor (see “Installation”).
- The free end of the hose is under water (see “Installation”).
- If the dwelling is on one of the upper floors of a building, there may be problems relating to water drainage, causing the Washer-dryer to fill with water and drain continuously. Special anti-draining valves are available in shops and help to prevent this inconvenience.
- The wall drainage system is not fitted with a breather pipe.

The Washer-dryer does not drain or spin.

- The wash cycle does not include draining: Some wash cycles require the drain phase to be started manually (see “Wash cycles and options”).
- The “Easy iron” option is enabled: to complete the wash cycle, press the START/PAUSE button (“Wash cycles and options”).
- The drain hose is bent (see *Installation*).
- The drainage duct is clogged.

The machine vibrates a lot during the spin cycle.

- The drum was not unlocked correctly during installation (see “Installation”).
- The machine is not level (see “Installation”).
- The machine is trapped between cabinets and walls (see “Installation”).
- The load is unbalanced (see “Detergents and laundry”).

The Washer-dryer leaks.

- The water inlet hose is not screwed on properly (see “Installation”).
- The detergent dispenser is blocked (to clean it, see “Care and maintenance”).
- The drain hose is not fixed in place properly (see “Installation”).

The icons corresponding to the “Phase in progress” flash rapidly at the same time as the ON/OFF indicator light.

- Switch off the machine and unplug it, wait for approximately 1 minute and then switch it back on again. If the problem persists, contact the Technical Assistance Service.

There is too much foam.

- The detergent is not suitable for machine washing (it should display the text “for Washer-dryer” or “hand and machine wash”, or the like).
- Too much detergent was used.

The washer-dryer does not dry.

- The appliance is not plugged into the socket, or not enough to make contact.
- There has been a power failure.
- The appliance door is not shut properly.
- A DELAY TIMER has been set.
- DRYING is in the OFF position.

Instruction Sheet

EN

Manufacturer's name	Whirlpool Management EMEA S.r.l. - Via Carlo Pisacane n.1 - 20016 Pero (MI) - Italy
Description model	AQD1170D 49 60HZ
Country of production	Italy
Rated Voltage (V)	220/240 V
Rated Frequency (Hz)	60 Hz
Rated Power (W)	1850 W
Net Weight (kg)	75.8 kg
Rated Capacity (kg)	from 1 to 11 kg for the wash programme from 1 to 7 kg for the drying programme
Annual Energy Consumption (kWh/year)	kWh/year 244
Annual Water Consumption (liters/year)	liters/year 10397
Dimensions	width 59.5 cm height 85 cm depth 64.5 cm
Connecting the drain hose	<p>Connect the drain hose, without bending it, to a drain duct or a wall drain situated between 65 and 100 cm from the floor.</p> <p>Alternatively, place the drain hose over the edge of a washbasin or bathtub, by fastening the guide  (which can be purchased at the technical assistance centre) to the tap. The free end of the hose should not be underwater.</p> <p>! We advise against the use of hose extensions; if it is absolutely necessary, the extension must have the same diameter as the original hose and must not exceed 150 cm in length.</p>
Electrical connections	<p>Before plugging the appliance into the mains socket, make sure that:</p> <ul style="list-style-type: none"> • the socket is earthed and in compliance with the applicable law; • the socket is able to sustain the appliance's maximum power load indicated on the Technical Data Plate fixed on the machine; • the supply voltage is included within the values indicated on the Technical Data Plate fixed on the machine. • the socket is compatible with the washing machine's plug. If this is not the case, replace the socket or the plug.
General safety	<ul style="list-style-type: none"> • This appliance was designed for domestic use only. • This appliance can be used by children aged from 8 years and above and persons with reduced physical, sensory or mental capabilities or lack of experience and knowledge if they have been given supervision or instruction concerning use of the appliance in a safe way and understand the hazards involved. Children shall not play with the appliance. Cleaning and user maintenance shall not be made by children without supervision. • Do not touch the machine when barefoot or with wet or damp hands or feet. • Do not pull on the power supply cable when unplugging the appliance from the electricity socket. Hold the plug and pull. • Do not open the detergent dispenser drawer while the machine is in operation. • Do not touch the drained water as it may reach extremely high temperatures. • Never force the porthole door. This could damage the safety lock mechanism designed to prevent accidental opening. • If the appliance breaks down, do not under any circumstances access the internal mechanisms in an attempt to repair it yourself. • Always keep children well away from the appliance while it is operating. • The door can become quite hot during the wash cycle. • If the appliance has to be moved, work in a group of two or three people and handle it with the utmost care. Never try to do this alone, because the appliance is very heavy. • Before loading laundry into the washer-dryer, make sure the drum is empty. • This machine must not be operated in a non air-conditioned environment.
Unpacking and levelling	<ol style="list-style-type: none"> 1. Remove the washer-dryer from its packaging. 2. Make sure that the washer-dryer has not been damaged during the transportation process. If it has been damaged, contact the retailer and do not proceed any further with the installation process. 3. Remove the 4 protective screws (used during transportation) and the rubber washer with the corresponding spacer, located on the rear part of the appliance. 4. Close off the holes using the plastic plugs provided. 5. Keep all the parts in a safe place: you will need them again if the washer-dryer needs to be moved to another location. <p>! Packaging materials should not be used as toys for children.</p>



The Gulf Conformity Marking on the product indicates the conformity with all the requirements of the Gulf Technical Regulation for Low Voltage Electrical Equipment and Appliances BD-142004-01