

DAILY REFERENCE GUIDE



THANK YOU FOR PURCHASING A BAUKNECHT PRODUCT

To receive more comprehensive help and support, please register your product at www.bauknecht.com/register



You can download the Safety Instructions and the Use and Care Guide by visiting our website docs.bauknecht.eu and following the instructions on the back of this booklet.



Before using the appliance carefully read the Health and Safety guide.

PRODUCT DESCRIPTION

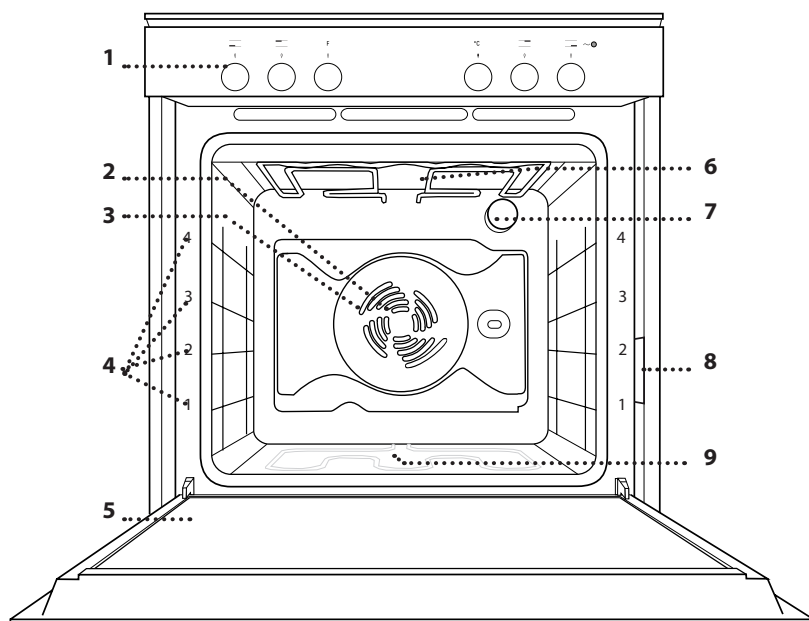

1. Control panel
2. Fan
3. Circular heating element (non-visible)
4. Shelf guides (the level is indicated on the front of the oven)
5. Door
6. Upper heating element/grill
7. Lamp
8. Identification plate (do not remove)
9. Bottom heating element (non-visible)

CONTROL PANEL

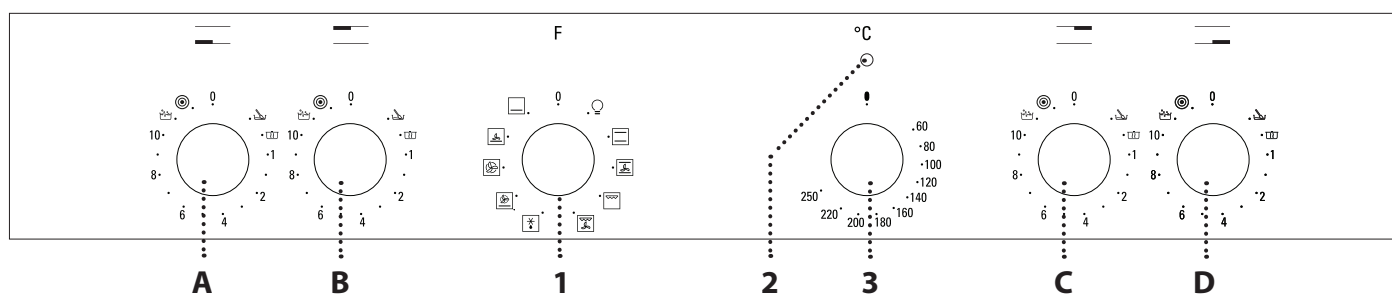

OVEN CONTROLS

1. SELECTION KNOB

For switching the oven on by selecting a function. Turn to the 0 position to switch the oven off.

2. LED THERMOSTAT / PREHEATING

Switches on during the heating process. Switches off once the desired temperature is reached.

3. THERMOSTAT KNOB

Turn to select the temperature you require.

COOKTOP CONTROLS

A. for front left hotplate.

B. for rear left hotplate.

C. for rear right hotplate.

D. for front right hotplate.

ACCESSORIES

WIRE SHELF

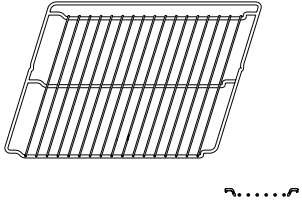

BAKING TRAY

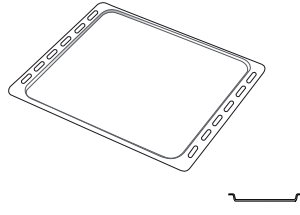

The number and the type of accessories may vary depending on which model is purchased. Other accessories that are not supplied can be purchased separately from the After-sales Service.

INSERTING THE WIRE SHELF AND OTHER ACCESSORIES

Insert the wire shelf horizontally by sliding it across the shelf guides, making sure that the side with the raised edge is facing upwards.

Other accessories, such the baking tray, are inserted horizontally in the same way as the wire shelf.

REMOVING AND REFITTING THE SHELF GUIDES

- To remove the shelf guides, remove the fixing screws (if present) on both sides with the aid of a coin or a tool. Lift the guides up and pull the lower parts out of their seatings: The shelf guides can now be removed.
- To refit the shelf guides, first fit them back into their upper seating. Keeping them held up, slide them into the cooking compartment, then lower them into position in the lower seating. Refit the fixing screws.

OVEN FUNCTIONS

0 OFF
For switching off the oven.

 **LIGHT**
To switch the oven light on/off.

 **CONVENTIONAL**
For cooking any kind of dish on one shelf only.

 **CONVECTION BAKE**
For cooking meat or baking cakes with liquid centre on a single shelf.

 **GRILL**
For grilling steaks, kebabs and sausages, cooking vegetables au gratin or toasting bread. When grilling meat, we recommend using a tray to collect the cooking juices: Position the pan on any of the levels below the wire shelf and add 500 ml of drinking water.

 **TURBO GRILL**
For roasting large joints of meat (legs, roast beef, chicken). We recommend using a tray to collect the cooking juices: Position the pan on any of the levels below the wire shelf and add 500 ml of drinking water.

 **DEFROST**
To speed up defrosting of food. Place food on the middle shelf. Leave food in its packaging in order to prevent it from drying out on the outside.

 **TURBOFAN**
For food with a crisp base and soft top. Ideal for cooking cakes with liquid filling and no precooked base on a single shelf. Place food on the 2nd shelf. This function is also ideal for frozen convenience foods. Follow the instructions on the product packaging.



 **FORCED AIR**
For cooking a variety of food requiring the same cooking temperature on a maximum of two shelves at the same time (e.g.: fish, vegetables, cakes). This function can be used to cook different foods without odours being transferred from one food to another.



 **BOTTOM + FAN**
To finish cooking food with a very liquid consistency and to obtain crisp, golden bases. Also useful for thickening sauces. Place food on the 2nd shelf.



 **BOTTOM HEATING**
For browning the base of dishes at the end of cooking. This function can also be used for slow cooking meat or stews. Place food on the 1st or 2nd shelf.



COOKTOP FUNCTIONS TABLE

0 OFF
For switching off the hotplate.

 **GENTLE HEAT**
To allow dough to rise, to soften butter taken from the fridge, to keep baby bottles or food warm, also for making yoghurt, melting chocolate, etc. This function is only available when the residual heat indicator is on. For this function, make sure the residual heat indicator of the desired hotplate is on. Turn the knob to . To deselect the function, change the position of the knob.

 **HEAT MAINTENANCE**
To maintain a constant temperature of 60° until the end of cooking. To select this function, turn the knob to .

 **FAST BOIL**
This function is used to bring water to the boil rapidly and remains on for a preset time. At the end of the preset time, the cooktop automatically returns to the maximum power setting. This function can be selected even during cooking. Important: before selecting this function, make sure the pot is positioned on the selected hotplate in order to avoid any damage to the cooktop surface. The stated performance values for this function are those guaranteed for all glass ceramic cooktops. For this function, place the pot on the selected hotplate and turn the knob to . To deselect, change the position of the knob.

 **MULTIZONE**
This is available on the front left and rear left hotplates. This extends the heating area of the cooktop in order to allow the use of large, oval or rectangular pots or cooking receptacles. To select this function: turn the knob to  and wait until the residual heat indicator for the hotplate begins to flash. To switch on the triple zone function (if available), wait until the LED begins flashing quickly. Select the power setting required by turning the knob anticlockwise. The residual heat indicator remains on to indicate that the cooktop is in use. To deselect, turn the knob to 0 by turning the knob anticlockwise.

USING THE APPLIANCE FOR THE FIRST TIME

HEAT THE OVEN

A new oven may release odours that have been left behind during manufacturing: this is completely normal.

Before starting to cook food, we therefore recommend heating the oven with it empty in order to remove any possible odours.

Remove any protective cardboard or transparent film from the oven and remove any accessories from inside it. Heat the oven to 250 °C for about one hour. The oven must be empty during this time. Follow the instructions for setting the function correctly.

Please note: It is advisable to air the room after using the appliance for the first time.

DAILY USE

1. SELECT A FUNCTION

To select a function, turn the *selection knob* to the symbol for the function you require.

2. ACTIVATE A FUNCTION

To start the function you have selected, turn the *thermostat knob* to set the temperature you require.

To interrupt the function at any time, switch off the oven, turn the *selection knob* and the *thermostat knob* to 0 and .

3. PREHEATING

Once the function has been activated, the LED thermostat will switch on signalling that the preheating process has begun. At the end of this process, the LED thermostat switches off indicating that the oven has reached the set temperature: at this point, place the food inside and proceed with cooking.

Please note: Placing the food in the oven before preheating has finished may have an adverse effect on the final cooking result.

• COOKTOP OPERATION

(see the instructions supplied with the cooktop).

Turn the control knob of the relevant hotplate clockwise to the desired power setting.



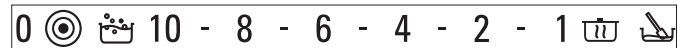



























































The oven control panel features 4 adjustable knobs for cooktop operation. The cooktop control knobs are marked with a numerical scale corresponding to different power settings, and a series of function symbols.











Please note: The multizone function can only be switched on for the double and triple hotplates of the cooktop.























Turn the control knob of the relevant hotplate clockwise to the desired power setting.

COOKING TABLE

RECIPE	FUNCTION	PREHEAT	TEMPERATURE (°C)	DURATION (Min.)	SHELF AND ACCESSORIES
Leavened cakes		Yes	150 - 175	35 - 90	2 
		Yes	150 - 170	30 - 90	3 1  
Filled cakes (cheesecake, strudel, apple pie)		Yes	150 - 190	30 - 85	2 
		Yes	150 - 190	35 - 90	3 1  
Biscuits / Tartlets		Yes	160 - 175	20 - 45	3 
		Yes	150 - 175	20 - 45	3 1  
Choux buns		Yes	175 - 200	30 - 40	2 
		Yes	170 - 190	35 - 45	3 1  
Meringues		Yes	100	110 - 150	2 
		Yes	100	130 - 150	3 1  
Bread / Pizza / Focaccia		Yes	225 - 250	12 - 50	2 
		Yes	225 - 250	25 - 50	3 1  
Frozen pizza		Yes	250	10 - 15	2 
		Yes	250	10 - 20	3 1  
Savoury pies (vegetable pie, quiche)		Yes	175 - 200	40 - 50	2 
		Yes	175 - 190	55 - 65	3 1  
Vols-au-vent / Puff pastry crackers		Yes	175 - 200	20 - 30	2 
		Yes	175 - 200	25 - 45	3 1  
Lasagne / Baked pasta / Cannelloni / Flans		Yes	200	45 - 65	2 
Lamb / Veal / Beef / Pork 1 kg		Yes	200	80 - 110	2 
Chicken / Rabbit / Duck 1 kg		Yes	200	50 - 100	2 
Turkey / Goose 3 kg		Yes	200	80 - 130	1 / 2 
Baked fish / en papillote (fillets, whole)		Yes	175 - 200	40 - 60	2 
Stuffed vegetables (tomatoes, courgettes, aubergines)		Yes	175 - 200	50 - 60	2 
Toast		-	200	3 - 5	4 
Fish fillets / Steaks		-	200	20 - 30	4 2  

FUNCTIONS					
	Conventional	Grill	TurboGrill	Forced Air	Convection Bake











ACCESSORIES					
	Wire shelf	Cake tin on wire shelf	Baking tray or cake tin on wire shelf	Baking tray with 500 ml of water	Baking tray

RECIPE	FUNCTION	PREHEAT	TEMPERATURE (°C)	DURATION (Min.)	SHELF AND ACCESSORIES
Sausages / Kebabs / Spare ribs / Hamburgers		-	200	30 - 40	4 3  
Roast chicken 1-1.3 kg		-	200	55 - 70 *	2 1  
Roast beef rare 1 kg		-	200	35 - 50 *	2 
Leg of lamb / Shanks		-	200	60 - 90 **	2 
Roast potatoes		-	200	45 - 55 **	2 
Vegetable gratin		-	200	20 - 30	2 
Lasagna & Meat		Yes	200	50 - 100 ***	3 1  
Meat & Potatoes		Yes	200	45 - 100 ***	3 1  
Fish & Vegetables		Yes	175	30 - 50 ***	3 1  

* Turn food halfway through cooking.

** Turn food two thirds of the way through cooking (if necessary).

*** Estimated length of time: dishes can be removed from the oven at different times depending on personal preference.

FUNCTIONS					
	Conventional	Grill	TurboGrill	Forced Air	Convection Bake
ACCESSORIES					
	Wire shelf	Cake tin on wire shelf	Baking tray or cake tin on wire shelf	Baking tray with 500 ml of water	Baking tray

HINTS AND TIPS

HOW TO READ THE COOKING TABLE

The table lists the best function, accessories and level to use to cook different types of food. Cooking times start from the moment food is placed in the oven, excluding preheating (where required). Cooking temperatures and times are approximate and depend on the amount of food and the type of accessory used. Use the lowest recommended settings to begin with and, if the food is not cooked enough, then switch to higher settings. Use the accessories supplied and preferably dark-coloured metal cake tins and baking trays. You can also use Pyrex or stoneware pans and accessories, but bear in mind that cooking times will be slightly longer.

DESSERTS

To check whether a leavened cake is cooked, insert a wooden toothpick into the centre of the cake. If the toothpick comes out clean, the cake is ready. If using non-stick baking pans, do not butter the edges as the cake may not rise evenly around the edges. If the item "swells" during baking, use a lower temperature next time and consider reducing the amount of liquid you add or stirring the mixture more gently.

MEAT

Use any kind of oven tray or pyrex dish suited to the size of the piece of meat being cooked. For roast joints, it is best to add some stock to the bottom of the dish, basting the meat during cooking for added flavour. Please note that steam will be generated during this operation. When the roast is ready, let it rest in the oven for another 10-15 minutes, or wrap it in aluminium foil. When you want to grill meat, choose cuts with an even thickness all over in order to achieve uniform cooking results. Very thick pieces of meat require longer cooking times. To prevent the meat from burning on the outside, lower the position of the wire shelf, keeping the food farther away from the grill. Turn the meat two thirds of the way through cooking. Take care when opening the door as steam will escape. To collect the cooking juices, we recommend placing a dripping pan filled with half a litre of drinking water directly underneath the wire shelf on which the food is placed. Top-up when necessary.

PIZZA

Lightly grease the trays to ensure the pizza has a crispy base. Scatter the mozzarella over the pizza two thirds of the way through cooking.

CLEANING AND MAINTENANCE

Make sure that the oven has cooled down before carrying out any maintenance or cleaning.

Do not use steam cleaners.

Do not use wire wool, abrasive scourers or abrasive/corrosive cleaning agents, as these could damage the surfaces of the appliance.

Wear protective gloves.

The oven must be disconnected from the mains before carrying out any kind of maintenance work.

CLEANING EXTERIOR SURFACES

Clean the surfaces with a damp microfibre cloth. If they are very dirty, add a few drops of pH-neutral detergent. Finish off with a dry cloth.

Do not use corrosive or abrasive detergents. If any of these products inadvertently comes into contact with the surfaces of the appliance, clean immediately with a damp microfibre cloth.

CLEANING INTERIOR SURFACES

After every use, leave the oven to cool and then clean it, preferably while it is still warm, to remove any deposits or stains caused by food residues. To dry any condensation that has formed as a result of cooking foods with a high water content, leave the oven to cool completely and then wipe it with a cloth or sponge.

Clean the glass in the door with a suitable liquid detergent.

The oven door can be removed to facilitate cleaning.

CLEANING ACCESSORIES

Soak the accessories in a washing-up liquid solution after use, handling them with oven gloves if they are still hot. Food residues can be removed using a washing-up brush or a sponge.

REPLACING THE LAMP

1. Disconnect the oven from the power supply.
2. Unscrew the cover from the light, replace the bulb and screw the cover back on the light.
3. Reconnect the oven to the power supply.

Please note: Only use 20-40W/230 V type G9, T300°C halogen lamps. The bulb used in the product is specifically designed for domestic appliances and is not suitable for general room lighting within the home (EC Regulation 244/2009). Light bulbs are available from our After-sales Service.

When using halogen bulbs, do not handle them with your bare hands as your fingerprints could cause damage. Do not use the oven until the light cover has been refitted.

REMOVING AND REFITTING THE DOOR

1. To remove the door, open it fully and lower the catches until they are in the unlock position.

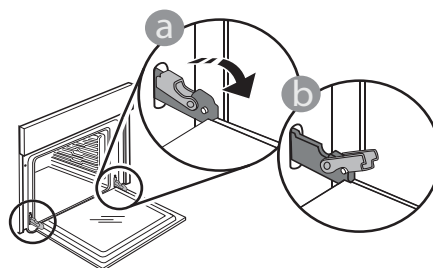

2. Close the door as much as you can. Take a firm hold of the door with both hands – do not hold it by the handle. Simply remove the door by continuing to close it while pulling it upwards at the same time until it is released from its seating. Put the door to one side, resting it on a soft surface.

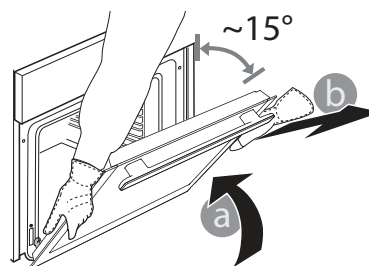

3. Refit the door by moving it towards the oven, aligning the hooks of the hinges with their seating and securing the upper part onto its seating.

4. Lower the door and then open it fully. Lower the catches into their original position: Make sure that you lower them down completely.

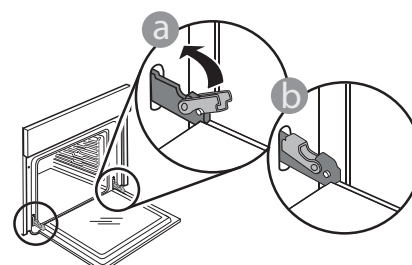

Apply gentle pressure to check that the catches are in the correct position.

5. Try closing the door and check to make sure that it lines up with the control panel. If it does not, repeat the steps above: The door could become damaged if it does not work properly.

Problem	Possible cause	Solution
The oven is not working.	Power cut. Disconnection from the mains.	Check for the presence of mains electrical power and whether the oven is connected to the electricity supply. Turn off the oven and restart it to see if the fault persists.

PRODUCT FICHE

 [www](http://www.bauknecht.eu) The product fiche with energy data of this appliance can be downloaded from the website docs.bauknecht.eu

HOW TO OBTAIN THE USE AND CARE GUIDE

>  [www](http://www.bauknecht.eu) Download the Use and Care Guide from our website docs.bauknecht.eu (you can use this QR Code), specifying the product's commercial code.



> Alternatively, contact our Client After-sales Service.

CONTACTING OUR AFTER-SALES SERVICE

You can find our contact details in the warranty manual. When contacting our Client After-sales Service, please state the codes provided on your product's identification plate.

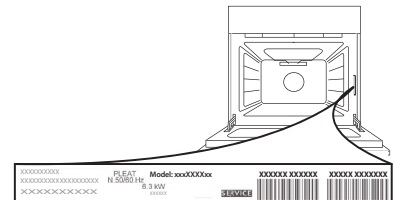

KURZANLEITUNG



**DANKE, DASS SIE SICH FÜR EIN
BAUKNECHT PRODUKT ENTSCHEIDEN
HABEN**

Für eine umfassende Hilfe und Unterstützung, registrieren Sie bitte Ihr Gerät unter www.bauknecht.com/register



Die Sicherheitshinweise und Gebrauchsanleitung können auf unserer Internetseite docs.bauknecht.eu heruntergeladen werden, bitte die Anweisungen auf der Rückseite des Heftes befolgen.



Lesen Sie vor Inbetriebnahme des Geräts sorgfältig die Sicherheitshinweise.

PRODUKTBESCHREIBUNG

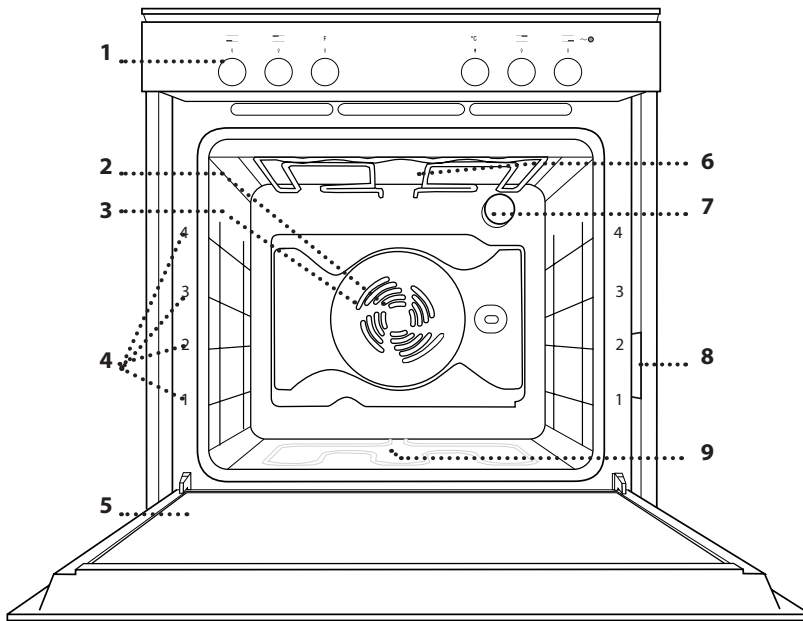

1. Bedienfeld
2. Gebläse
3. Ringheizelement (nicht sichtbar)
4. Seitengitter (die Einschubebene wird auf der Vorderseite des Ofens angezeigt)
5. Tür
6. Oberes Heizelement/Grill
7. Lampe
8. Typenschild (nicht entfernen)
9. Bodenheizelement (nicht sichtbar)

BEDIENFELD

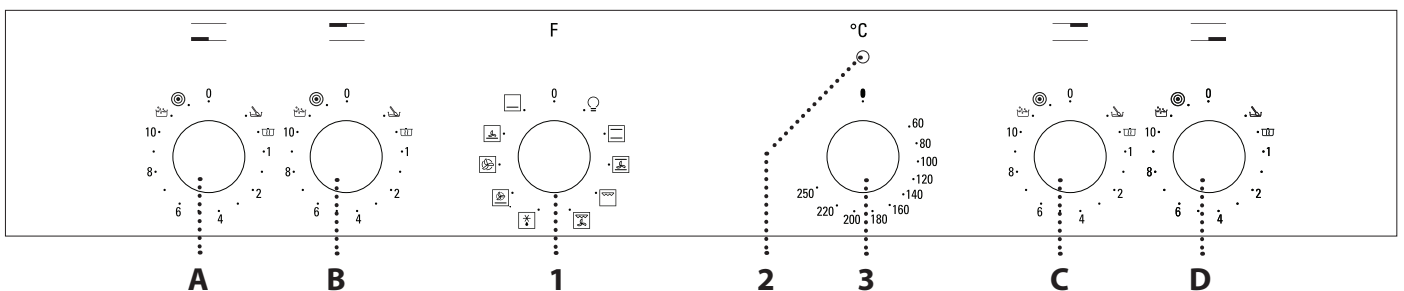

OFENBEDIENELEMENTE

1. AUSWAHLKNOPF

Zum Einschalten des Ofens durch Funktionsauswahl. Auf 0 drehen, um den Ofen auszuschalten.

2. KONTROLLLEUCHE THERMOSTAT/ VORHEIZEN

Schaltet sich während dem Heizvorgang an. Schaltet sich aus, wenn die gewünschte Temperatur erreicht ist.

3. THERMOSTATREGLER

Drehen Sie den Regler zum Wählen der gewünschten Temperatur.

KOCHFELD-BEDIENUNG

- A. Kochfeld vorne links.
- B. Kochfeld hinten links.
- C. Kochfeld hinten rechts.
- D. Kochfeld vorne rechts.

ZUBEHÖRTEILE

ROST

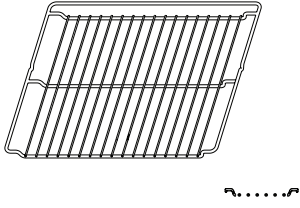

BACKBLECH

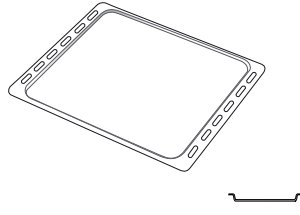

Die Anzahl und Art der Zubehörteile kann je nach gekauftem Modell variieren. Nicht mitgelieferte Zubehörteile sind separat über den Kundendienst erhältlich.

DEN ROST UND ANDERE ZUBEHÖRTEILE EINSETZEN

Den Rost horizontal einsetzen, indem dieser durch die Laufschiene geschoben wird; sicherstellen, dass die Seite mit dem erhöhten Rand nach oben zeigt.

Die anderen Zubehörteile, wie das Backblech, werden horizontal auf die gleiche Weise eingesetzt wie der Rost.

ENTFERNEN UND ERNEUTES ANBRINGEN DER SEITENGITTER

• Zum Entfernen der Seitengitter die Befestigungsschrauben (sofern vorhanden) auf beiden Seiten mithilfe einer Münze oder eines Werkzeugs entfernen. Dann die Gitter anheben und deren untere Teile aus ihren Halterungen ziehen: Jetzt können die Seitengitter entfernt werden.

• Zum erneuten Anbringen der Seitengitter, diese wieder in ihrem oberen Sitz anbringen. Die Seitengitter halten, in den Garraum schieben und anschließend in die Position im unteren Sitz herablassen. Drehen Sie die Befestigungsschrauben wieder ein.

OFENFUNKTIONEN

0 OFF

Zum Ausschalten des Ofens.



LAMPEN

Zum Ein-/Ausschalten der Ofenbeleuchtung.



OBER-/UNTERHITZE

Zum Garen aller Arten von Gerichten auf nur einer Einschubebene.



UMLUFT

Zum Garen von Fleisch oder Backen von Kuchen mit flüssiger Füllung auf einer Einschubebene.



GRILL

Zum Grillen von Steaks, Grillspießen und Bratwürsten, zum Überbacken von Gemüse oder Rösten von Brot. Beim Grillen von Fleisch wird die Verwendung einer Fettpfanne zum Aufsammeln der Garflüssigkeiten empfohlen: Die Fettpfanne unter eine beliebige Einschubebene unter den Rost stellen und 500 ml Trinkwasser zufügen.



GRILL + HEISSLUFT

Zum Garen großer Fleischstücke (Keulen, Roastbeef, Hähnchen). Es wird die Verwendung einer Fettpfanne zum Aufsammeln der Garflüssigkeiten empfohlen: Die Fettpfanne unter eine beliebige Einschubebene unter den Rost stellen und 500 ml Trinkwasser zufügen.



AUFTAUEN

Zur Beschleunigung des Auftauens von Speisen. Das Gargut auf die mittlere Einschubebene geben. Es wird empfohlen, die Lebensmittel in ihrer Verpackung aufzutauen, um dem Austrocknen der Oberfläche vorzubeugen.



TURBOGEBLÄSE

Zum Backen von Speisen mit knusprigem Boden und weicher Oberfläche. Ideal zum Backen von Kuchen mit flüssiger Füllung und ohne vorgebackene Masse auf einer Einschubebene. Es wird empfohlen, das Gargut auf die 2. Ebene zu geben. Diese Funktion eignet sich auch für Tiefkühlfertigkost. Befolgen Sie die Hinweise auf der Lebensmittelpackung.



HEISSLUFT

Zum gleichzeitigen Garen verschiedener Speisen bei gleicher Temperatur auf maximal zwei Einschubebenen (z. B.: Fisch, Gemüse, Kuchen). Die Funktion erlaubt das Garen ohne Geschmacksübertragung von einer Speise auf die anderen.



UNTERHITZE + GEBLÄSE

Für das Ende der Backzeit bei sehr flüssigen Speisen sowie für knusprige und schön gebräunte Böden. Sehr gut auch zum Eindicken von Soßen. Es wird empfohlen, das Gargut auf die 2. Ebene zu geben.





UNTERHITZE



Zum Bräunen des Bodens einer Speise nach Beendigung des Garvorgangs. Diese Funktion kann auch zum langsamen Garen von Fleisch oder Eintöpfen verwendet werden. Das Gargut auf die 1. oder 2. Einschubebene geben.



ÜBERSICHT DER KOCHFELDFUNKTIONEN

0 OFF
Zum Ausschalten des Kochfelds.

 **SCHMELZSTUFE**
Zum Aufgehen von Teig, Aufweichen von gekühlter Butter, Warmhalten von Milch in der Trinkflasche oder von Babynahrung, zur Herstellung von Joghurt, zum Schmelzen von Schokolade, usw. Diese Betriebsart funktioniert nur bei leuchtender Restwärme-Kontrollleuchte. Achten Sie darauf, dass die Restwärme-Kontrollleuchte der Kochzone leuchtet, die Sie verwenden möchten. Drehen Sie den Bedienknopf auf . Zum Abschalten der Funktion brauchen Sie nur die Position des Bedienknopfes zu ändern.

 **WARMHALTEN**
Zur Beibehaltung einer gleichbleibenden Temperatur von 60 °C im Backofen. Zum Auswählen dieser Funktion drehen Sie den Bedienknopf auf .

 **TURBOSTUFE**
Mit dieser Funktion kann Wasser schneller zum Sieden gebracht werden. Sie bleibt für eine vorgegebene Zeit eingeschaltet. Nach Ablauf dieser Zeit schaltet die Kochzone automatisch zur höchsten Leistungsstufe zurück. Die Funktion kann auch während eines Garvorgangs zugeschaltet werden. **WICHTIG:** Stellen Sie vor dem Einschalten dieser Funktion einen Topf auf die entsprechende Kochzone, um die Oberfläche des Kochfelds nicht zu beschädigen. Die für diese Funktion angegebenen Leistungswerte werden für alle Glaskeramik-Kochfelder garantiert. Um die Funktion zu wählen, stellen Sie einen Topf auf die gewählte Kochzone, und drehen Sie den Bedienknopf auf . Zum Abschalten der Funktion brauchen Sie nur die Position des Bedienknopfes zu ändern.

 **MULTIZONE**
Diese Funktion ist für das vordere linke und hintere rechte Kochfeld zuschaltbar. Sie vergrößert den Heizbereich für besonders große, ovale oder rechteckige Töpfe. Zuschalten: Drehen Sie den Bedienknopf auf  und warten Sie, bis die entsprechende Restwärme-Kontrollleuchte blinkt. Zum Einschalten der dreifachen Kochzone (falls vorhanden) warten Sie, bis die Kontrollleuchte schneller blinkt. Dann stellen Sie die gewünschte Leistungsstufe durch Drehen des Bedienknopfes gegen den Uhrzeigersinn ein. Die Restwärme-Kontrollleuchte leuchtet weiterhin, um anzuzeigen, dass das Kochfeld eingeschaltet ist. Zum Ausschalten den Bedienknopf auf **0** drehen.

ERSTE INBETRIEBNAHME DES GERÄTS

AUFHEIZEN DES OFENS

Ein neuer Ofen kann Gerüche freisetzen, die bei der Herstellung zurückgeblieben sind: Das ist ganz normal.

Vor dem Garen von Speisen wird daher empfohlen, den Ofen in leerem Zustand aufzuheizen, um mögliche Gerüche zu entfernen.

Schutzkarton und Klarsichtfolie aus dem Ofen entfernen und die Zubehörteile entnehmen.

Den Ofen auf 250 °C etwa eine Stunde lang aufheizen. Der Ofen muss während dieser Zeit leer sein. Die Anweisungen zur korrekten Einstellung der Funktion befolgen.

Bitte beachten: Es wird empfohlen, den Raum nach dem ersten Gebrauch des Geräts zu lüften.

TÄGLICHER GEBRAUCH

1. AUSWÄHLEN EINER FUNKTION

Um eine Funktion auszuwählen, den *Auswahlknopf* auf das Symbol für die gewünschte Funktion drehen.

2. EINE FUNKTION AKTIVIEREN

Um die Funktion zu aktivieren, müssen Sie den *Thermostatregler* auf die gewünschte Temperatur drehen.

Um die Funktion jederzeit zu unterbrechen, den Ofen ausschalten, den *Auswahlknopf* und den *Thermostatregler* auf 0 und ● drehen.

3. VORHEIZEN

Sobald die Funktion aktiviert wurde, schaltet sich die LED-Kontrollleuchte des Thermostats ein und zeigt damit an, dass der Vorheizprozess begonnen hat. Am Ende dieses Prozesses schaltet sich die LED-Kontrollleuchte des Thermostats aus und zeigt damit an, dass der Ofen die eingestellte Temperatur erreicht hat: An diesem Punkt die Speise in den Ofen stellen und den Garvorgang fortsetzen.

Bitte beachten: Wird die Speise in den Ofen gestellt, bevor das Vorheizen beendet ist, kann dies negative Auswirkungen auf das endgültige Garergebnis haben.

•BETRIEB DES KOCHFELDS

(siehe Bedienungsanleitung des Kochfelds).

Drehen Sie den Bedienknopf der zugehörigen Kochzone im Uhrzeigersinn auf die gewünschte Leistungsstufe.

Das Bedienfeld des Backofens verfügt über 4 Bedienknöpfe, mit denen das Kochfeld bedient wird. Die Bedienknöpfe sind mit einer Strichskala entsprechend den verschiedenen Leistungsstufen und verschiedenen Funktionssymbolen versehen.

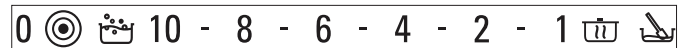

Bitte beachten: Die Funktion „Multizone“ lässt sich nur bei den doppelten oder dreifachen Kochzonen des Kochfelds verwenden.























Drehen Sie den Bedienknopf der zugehörigen Kochzone im Uhrzeigersinn auf die gewünschte Leistungsstufe.

GARTABELLE

REZEPT	FUNKTION	VORHEIZEN	TEMPERATUR (°C)	DAUER (Min)	ROST UND ZUBEHÖRTEILE
Hefekuchen		Ja	150 - 175	35 - 90	2
		Ja	150 - 170	30 - 90	3 1
Gefüllter Kuchen (Käsekuchen, Strudel, Apfelkuchen)		Ja	150 - 190	30 - 85	2
		Ja	150 - 190	35 - 90	3 1
Kekse / Törtchen		Ja	160 - 175	20 - 45	3
		Ja	150 - 175	20 - 45	3 1
Beignets		Ja	175 - 200	30 - 40	2
		Ja	170 - 190	35 - 45	3 1
Meringue		Ja	100	110 - 150	2
		Ja	100	130 - 150	3 1
Brot / Pizza / Fladenbrot		Ja	225 - 250	12 - 50	2
		Ja	225 - 250	25 - 50	3 1
Tiefkühlpizza		Ja	250	10 - 15	2
		Ja	250	10 - 20	3 1
Salzige Kuchen (Gemüsekuchen, Quiche)		Ja	175 - 200	40 - 50	2
		Ja	175 - 190	55 - 65	3 1
Blätterteigtörtchen / Herzhaftes Blätterteiggebäck		Ja	175 - 200	20 - 30	2
		Ja	175 - 200	25 - 45	3 1
Lasagne / überbackene Pasta / Cannelloni / Aufläufe		Ja	200	45 - 65	2
Lamm, Kalb, Rind, Schwein 1 kg		Ja	200	80 - 110	2
Hähnchen / Kaninchen / Ente 1 kg		Ja	200	50 - 100	2
Puter/Gans 3 kg		Ja	200	80 - 130	1/2
Fisch gebacken/in Folie (Filets, ganz)		Ja	175 - 200	40 - 60	2
Gefülltes Gemüse (Tomaten, Zucchini, Auberginen)		Ja	175 - 200	50 - 60	2
Toast		-	200	3 - 5	4
Fischfilets/Steaks		-	200	20 - 30	4 2

FUNKTIONEN					
	Ober-/Unterhitze	Grill	Grill + Heißluft	Heißluft	Umluft

ZUBEHÖRTEILE					
	Rost	Kuchenform auf Rost	Backblech oder Kuchenform auf Rost	Backblech mit 500 ml Wasser	Backblech

REZEPT	FUNKTION	VORHEIZEN	TEMPERATUR (°C)	DAUER (Min)	ROST UND ZUBEHÖRTEILE
Bratwürste / Grillspieße / Rippchen / Hamburger		-	200	30 - 40	4 3  
Brathähnchen 1-1,3 kg		-	200	55 - 70 *	2 1  
Roastbeef englisch 1 kg		-	200	35 - 50 *	2 
Lammkeule / Schweinshaxe		-	200	60 - 90 **	2 
Bratkartoffeln		-	200	45 - 55 **	2 
Gemüsegratin		-	200	20 - 30	2 
Lasagne, Fleisch		Ja	200	50 - 100 ***	3 1  
Fleisch & Kartoffeln		Ja	200	45 - 100 ***	3 1  
Fisch & Gemüse		Ja	175	30 - 50 ***	3 1  

* Das Gargut nach halber Garzeit wenden.

**Das Gargut nach zwei Dritteln der Garzeit wenden (bei Bedarf).

*** Voraussichtliche Zeitdauer: Je nach persönlichen Vorlieben können die Speisen zu verschiedenen Zeitpunkten aus dem Ofen genommen werden.

FUNKTIONEN	 Ober-/Unterhitze	 Grill	 Grill + Heißluft	 Heißluft	 Umluft
ZUBEHÖRTEILE	 Rost	 Kuchenform auf Rost	 Backblech oder Kuchenform auf Rost	 Backblech mit 500 ml Wasser	 Backblech

HINWEISE UND TIPPS

LESEN DER GARTABELLE

Die Tabelle listet die besten Funktionen, Zubehörteile und Einschubebenen auf, die für die verschiedenen Arten von Speisen zu verwenden sind. Die Garzeiten gelten ab dem Moment, in dem Sie das Gargut in den Ofen geben, die (eventuell erforderliche) Vorheizzeit zählt nicht dazu. Die Gartemperaturen und -zeiten sind nur Richtwerte und sind von der Menge des Garguts und von den verwendeten Zubehörteilen abhängig. Zunächst die niedrigeren Einstellungen verwenden und, falls das erzielte Garergebnis nicht den Wünschen entspricht, zu den höheren Einstellungen übergehen. Es wird empfohlen, die mitgelieferten Zubehörteile und vorzugsweise Kuchenformen und Backbleche aus dunklem Metall zu verwenden. Es können auch Töpfe und Zubehörteile aus feuerfestem Glas oder Keramik verwendet werden, aber es ist zu berücksichtigen, dass sich die Garzeiten dadurch etwas verlängern.

DESSERTS

Machen Sie bei Hefekuchen mit einem Zahnstocher eine Garprobe in der Mitte des Kuchens. Wenn der Zahnstocher trocken bleibt, ist der Kuchen fertig. Sollten beschichtete Backformen verwendet werden, die Ränder nicht einfetten, damit der Kuchen an den Rändern gleichmäßig aufgeht. Falls die Speise beim Backen aufgeht, wählen Sie beim nächsten Mal eine niedrigere Temperatur, etwas weniger Flüssigkeit und rühren Sie den Teig vorsichtiger.

FLEISCH

Verwenden Sie einen für die Größe des zu garenden Fleischstücks geeigneten Bräter oder eine entsprechende feuerfeste Ofenform. Garen Sie Braten möglichst in etwas Brühe und beschöpfen Sie das Fleisch während des Garens, damit es schmackhaft wird. Bitte beachten, dass während diesem Vorgang Dampf erzeugt wird. Lassen Sie den Braten nach dem Ende der Garzeit weitere 10-15 Minuten im Ofen ruhen oder wickeln Sie ihn in Alufolie. Für ein gleichmäßiges Garergebnis wählen Sie zum Grillen von Fleischstücken mehrere gleich dicke Scheiben. Sehr dicke Fleischstücke benötigen eine längere Garzeit. Um zu vermeiden, dass das Fleisch anbrennt, den Rost auf eine der unteren Einschubebenen versetzen und den Abstand der Fleischstücke zum Grill vergrößern. Wenden Sie das Fleisch nach zwei Dritteln der Garzeit. Die Tür vorsichtig öffnen, da heißer Dampf austritt. Zum Auffangen des Bratensafte eine Fettpfanne mit einem halben Liter Trinkwasser direkt unter dem Rost mit dem Fleisch positionieren. Füllen Sie bei Bedarf nach.

PIZZA

Fetten Sie die Bleche leicht ein, damit auch der Pizzaboden knusprig wird. Verteilen Sie den Mozzarella nach zwei Dritteln der Garzeit auf der Pizza.

REINIGUNG UND WARTUNG

Vor dem Ausführen beliebiger Wartungs- oder Reinigungsarbeiten sicherstellen, dass der Ofen abgekühlt ist.

Verwenden Sie keine Dampfreiniger.

Keine Stahlwolle, Scheuermittel oder aggressive/ätzende Reinigungsmittel verwenden, da diese die Flächen des Gerätes beschädigen können.

Schutzhandschuhe tragen.

Vor dem Ausführen beliebiger Wartungsarbeiten muss der Ofen von der Stromversorgung getrennt sein.

REINIGUNG DER AUSSENFLÄCHEN

Reinigen Sie die Flächen mit einem feuchten Mikrofasertuch. Sollten sie stark verschmutzt sein, einige Tropfen von pH-neutralem Reinigungsmittel verwenden. Reiben Sie mit einem trockenen Tuch nach.

Keine aggressiven Reinigungs- oder Scheuermittel verwenden. Falls ein solches Mittel versehentlich mit den Flächen des Geräts in Kontakt kommt, dieses sofort mit einem feuchten Mikrofasertuch reinigen.

REINIGUNG DER INNENFLÄCHEN

Den Ofen nach jedem Gebrauch abkühlen lassen und anschließend reinigen, vorzugsweise wenn dieser noch warm ist, um durch Speiserückstände verursachte Ablagerungen oder Flecken zu entfernen. Zum Trocknen von Kondensation, die sich beim Garen von Speisen mit einem hohen Wassergehalt bildet, den Ofen vollständig abkühlen lassen und anschließend mit einem Tuch oder Schwamm trockenwischen.

Das Glas der Backofentür mit einem geeigneten Flüssigreiniger reinigen.

Die Backofentür kann zum Reinigen vollständig ausgehängt werden.

REINIGUNG DER ZUBEHÖRTEILE

Die Zubehörteile nach dem Gebrauch in Geschirrspülmittellaug einweichen, Backofenhandschuhe verwenden, solange die Zubehörteile noch heiß sind. Speiserückstände können dann mit einer Spülbürste oder einem Schwamm entfernt werden.

AUSWECHSELN DER LAMPE

1. Trennen Sie den Ofen von der Stromversorgung.

2. Die Abdeckung von der Beleuchtung abschrauben, die Lampe ersetzen und die Abdeckung erneut an der Beleuchtung festschrauben.

3. Schließen Sie den Ofen wieder an das Stromnetz an.

Bitte beachten: Nur Halogenlampen des Typs 20-40W/230 V Typ G9, T300°C verwenden. Die im Gerät verwendete Lampe ist speziell für Elektrogeräte konzipiert und ist nicht für die Beleuchtung von Räumen geeignet (EU-Verordnung 244/2009). Die Glühlampen sind über unseren Kundendienst erhältlich. Bei der Verwendung von Halogenlampen, diese nicht mit bloßen Händen berühren, da sie durch die Fingerabdrücke beschädigt werden könnten. Den Backofen erst benutzen, nachdem die Abdeckung der Beleuchtung wieder aufgesetzt wurde.

AUSBAU UND ERNEUTES ANBRINGEN DER TÜR

1. Zur Entfernung der Tür, diese vollständig öffnen und die Haken senken, bis sie sich in entriegelter Position befinden.

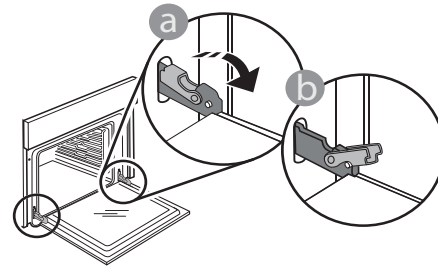

2. Die Tür so weit wie möglich schließen.

Die Tür mit beiden Händen festhalten – diese nicht am Griff festhalten.

Die Tür einfach entfernen, indem sie weiter geschlossen und gleichzeitig nach oben gezogen wird, bis sie sich aus ihrem Sitz löst. Die Tür seitlich abstellen und auf eine weiche Oberfläche legen.

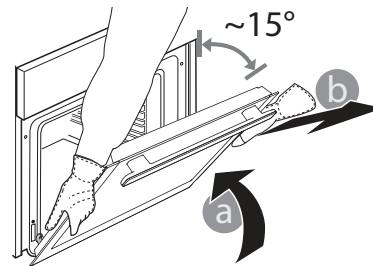

3. Die Tür erneut anbringen, indem sie zum Ofen geschoben wird und die Haken der Scharniere auf ihre Sitze ausgerichtet werden, den oberen Teil auf seinem Sitz sichern.

4. Die Tür senken und anschließend vollständig öffnen. Die Haken in ihre Ausgangsposition senken: Sicherstellen, dass die Haken vollständig gesenkt werden.

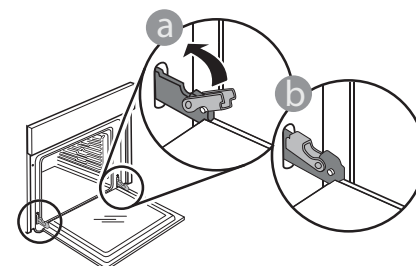

Einen leichten Druck ausüben, um zu überprüfen, dass sich die Haken in der korrekten Position befinden.

5. Versuchen, die Tür zu schließen und sicherstellen, dass sie auf das Bedienfeld ausgerichtet ist. Ist dies nicht der Fall, die oben aufgeführten Schritte wiederholen: Die Tür könnte beschädigt werden, wenn dies nicht richtig funktioniert.

Problem	Mögliche Ursache	Abhilfemaßnahme
Der Ofen funktioniert nicht.	Stromausfall. Trennung von der Stromversorgung.	Überprüfen, ob das Stromnetz Strom führt und der Backofen an das Netz angeschlossen ist. Schalten Sie den Backofen aus und wieder ein, um festzustellen, ob die Störung erneut auftritt.

TECHNISCHE DATEN

 Die technischen Daten mit Angabe der Energiedaten für dieses Gerät können auf der Internetseite docs.bauknecht.eu runtergeladen werden

WIE IST DIE GEBRAUCHSANLEITUNG ERHÄLTLICH?

>  Die Gebrauchsanleitung von der Internetseite docs.bauknecht.eu herunterladen (den QR-Code verwenden). Geben Sie dazu den Produkthandelscode an.



> Alternativ unseren Kundendienst kontaktieren.

UNSEREN KUNDENDIENST KONTAKTIEREN

Unsere Kontaktdaten sind im Garantiehandbuch zu finden. Wird der Kundendienst kontaktiert, bitte die Codes auf dem Typenschild des Produkts angeben.

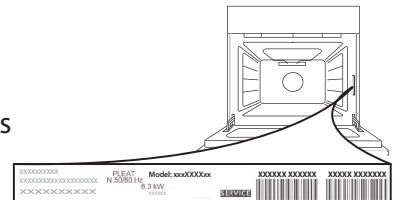

GUIDE D'UTILISATION QUOTIDIENNE



MERCI D'AVOIR ACHETÉ UN PRODUIT BAUKNECHT

Afin de recevoir un service et un support complet, merci d'enregistrer votre appareil sur www.bauknecht.com/register



Vous pouvez télécharger les Consignes de sécurité et le Guide d'utilisation et d'entretien en visitant notre site Web docs.bauknecht.eu et en suivant les consignes au dos de ce livret.

! Lire attentivement les Consignes de santé et de sécurité avant d'utiliser l'appareil.

DESCRIPTION DU PRODUIT

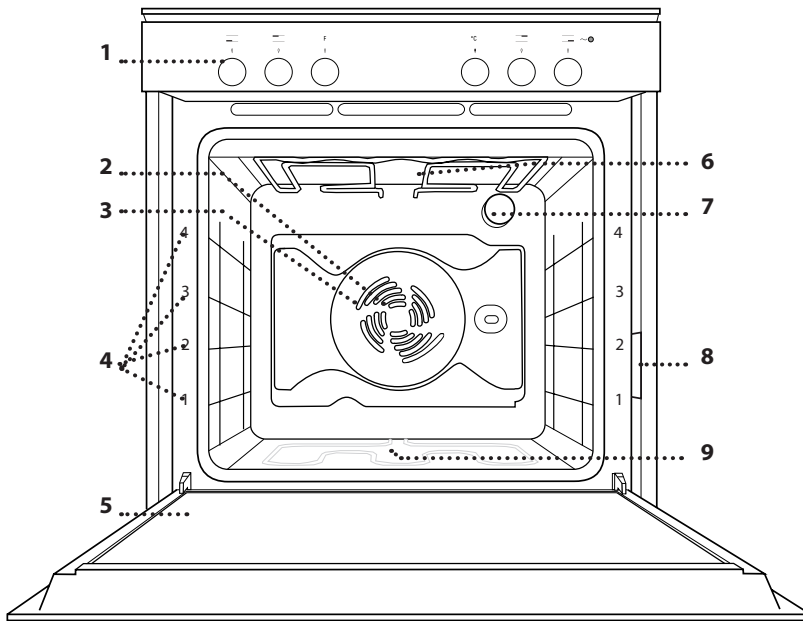

1. Panneau de commande
2. Ventilateur
3. Élément chauffant rond (invisible)
4. Supports de grille (le niveau est indiqué à l'avant du four)
5. Porte
6. Élément chauffant supérieur/gril
7. Ampoule
8. Plaque signalétique (ne pas enlever)
9. Élément chauffant inférieur (invisible)

PANNEAU DE COMMANDE

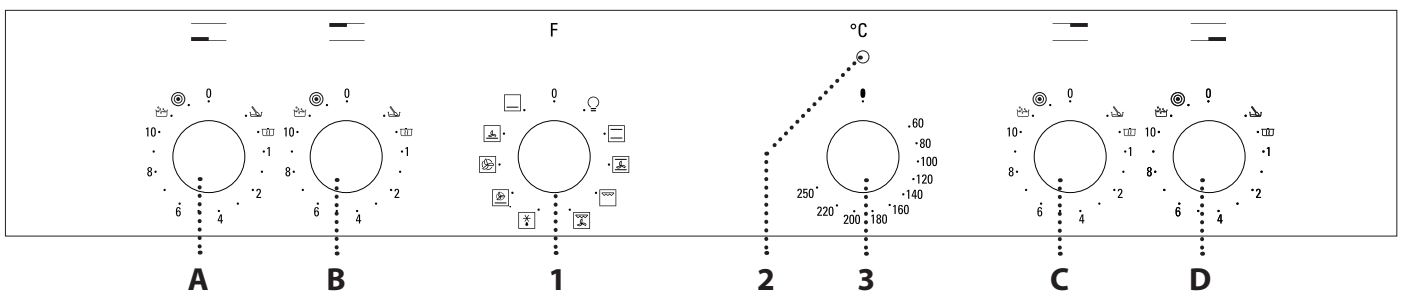

COMMANDES DU FOUR

1. BOUTON DE SÉLECTION

Pour allumer le four en sélectionnant une fonction. Tournez à la position 0 pour éteindre le four.

2. VOYANT THERMOSTAT / PRÉCHAUFFAGE

S'allume pendant le processus de chauffage. S'éteint une fois la température désirée atteinte.

3. BOUTON THERMOSTAT

Tournez pour sélectionner la température désirée.

COMMANDES TABLES DE CUISSON

- A. pour la zone de cuisson avant gauche.
 B. pour la zone de cuisson arrière gauche.
 C. pour la zone de cuisson arrière droite.
 D. pour la zone de cuisson avant gauche.

ACCESSOIRES

GRILLE MÉTALLIQUE

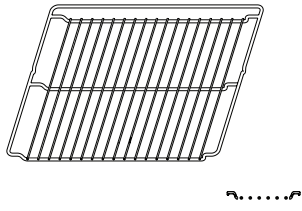

PLAQUE DE CUISSON

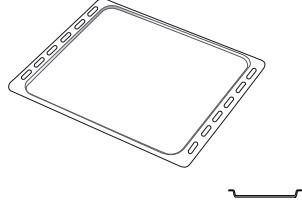

Le nombre et type d'accessoires peuvent varier selon le modèle acheté.

Pour les accessoires qui ne sont pas fournis, il est possible de les acheter séparément auprès du Service Après-Vente.

INSÉRER LA GRILLE MÉTALLIQUE ET LES AUTRES ACCESSOIRES

Insérez la grille métallique horizontalement en la glissant sur les supports de grille, assurez-vous que le côté avec le bord relevé est placé vers le haut.

Les autres accessoires, comme la plaque de cuisson, sont insérés à l'horizontale, de la même manière que la grille métallique.

ENLEVER ET REPLACER LES SUPPORTS DE GRILLE

• Pour enlever les supports de grille, enlevez les vis de fixation (selon le modèle) sur les deux côtés à l'aide d'une pièce de monnaie ou d'un outil. Soulevez les supports et sortez les parties inférieures de leurs appuis : Les supports de grille peuvent maintenant être enlevés.

• Pour replacer les supports de grille, vous devez en premier les replacer dans leur appui supérieur. En les maintenant soulevés, glissez-les dans le compartiment de cuisson, abaissez-les ensuite dans leur appui inférieur. Remplacez les vis de fixation.

FONCTIONS DU FOUR

0 OFF

Pour éteindre le four.



ÉCLAIRAGE

Pour allumer/éteindre la lumière du four.



CONVEC NATURELLE

Pour cuire tout type de plat sur une seule grille.



CONVECTION FORCÉE

Pour cuire de la viande ou des gâteaux avec un centre liquide sur une seule grille.



GRIL

Pour cuire des biftecks, des brochettes, et des saucisses, faire gratiner des légumes et griller du pain. Pour la cuisson de la viande, nous vous conseillons d'utiliser une lèchefrite pour recueillir les jus de cuisson : Placez la lèchefrite, contenant 500 ml d'eau, sur n'importe quel niveau sous la grille.



TURBO GRIL

Pour griller de gros morceaux de viande (gigots, rôti de bœuf, poulet). Nous vous conseillons d'utiliser une lèchefrite pour recueillir les jus de cuisson : Placez la lèchefrite, contenant 500 ml d'eau, sur n'importe quel niveau sous la grille.



DÉCONGÉLATION

Pour accélérer la décongélation des aliments. Placez les aliments sur la grille du milieu. Laissez la nourriture dans son emballage pour empêcher qu'elle se dessèche.



VENTILATEUR TURBO

Pour les aliments avec une base croustillante et un dessus moelleux. Idéale pour cuire sur un seul niveau des tartes avec une garniture liquide sans base précuite. Utilisez la 2e fente. Cette fonction est aussi idéale pour les produits surgelés. Suivez les instructions sur l'emballage du produit.



CHALEUR PULSÉE

Pour cuire des aliments différents, nécessitant la même température de cuisson, en même temps sur un maximum de deux grilles (p. ex. : poisson, légumes, gâteaux). Cette fonction permet de cuire différents aliments sans transmettre les odeurs d'un aliment à l'autre.



SOLE + VENTILÉ

Pour finir la cuisson d'aliments à consistance liquide et pour obtenir des bases croustillantes et dorées. Utile aussi pour épaissir les sauces. Utilisez la 2e fente.



CHAUFFAGE INFÉRIEUR

Pour dorer la base de vos plats à la fin de la cuisson. Cette fonction peut également être utilisée pour cuire lentement de la viande ou des ragoûts. Placer l'aliment sur la 1ère ou la 2nde fente.

TABLEAU DES FONCTIONS DE LA TABLE DE CUISSON

0 OFF
Pour éteindre la zone de cuisson.

CHAUFFAGE LENT

Utilisez cette fonction pour faire lever une pâte, ramollir une plaquette de beurre dur sortie du réfrigérateur, réchauffer un biberon ou le repas d'un bébé, fabriquer du yaourt, faire fondre du chocolat, etc. Cette fonction est disponible uniquement lorsque l'indicateur de chaleur résiduelle est allumé. Vérifiez que l'indicateur de chaleur résiduelle de la zone de cuisson que vous désirez utiliser est allumé. Positionnez le bouton sur . Pour désactiver la fonction, changez la position du bouton.

MAINTIEN AU CHAUD

Cette fonction permet de maintenir la température du four à 60 °C jusqu'à la fin du cycle de cuisson. Pour sélectionner cette fonction, réglez le bouton sur .

ÉBULLITION RAPIDE

Cette fonction permet d'amener rapidement l'eau à ébullition et reste active pendant la durée prédéfinie. Dès que la durée de cuisson est écoulée, la table de cuisson retourne automatiquement à la puissance maximale. La fonction Ébullition rapide peut également être activée une fois que vous avez déjà commencé à cuisiner. Important : Veillez à placer l'ustensile de cuisson sur la zone de cuisson avant d'activer la fonction Ébullition rapide. À défaut, vous risqueriez d'endommager la surface vitrocéramique. Les performances spécifiées pour la fonction Ébullition rapide sont garanties pour tous les types de tables de cuisson vitrocéramiques. Pour activer la fonction, placez la cocotte sur la zone de cuisson désirée et réglez le bouton sur . Pour désactiver la fonction, changez la position du bouton.

MULTI ZONE

Disponible sur les plaques chauffantes avant gauches et arrière gauches. Ceci permet d'étendre la zone chauffante de la table de cuisson de façon à permettre l'utilisation de casseroles ou de plats de cuisson de grande taille, de forme ovale ou rectangulaire. Pour sélectionner cette fonction : tournez le bouton sur  et attendez que le voyant de chaleur résiduelle de la plaque chauffante commence à clignoter. Pour activer la triple zone (si présente), attendez que le clignotement du voyant s'accélère. Sélectionnez la puissance désirée en tournant le bouton dans le sens inverse des aiguilles d'une montre. Le voyant de chaleur résiduelle reste allumé, indiquant que la table de cuisson est sous tension. Pour supprimer cette fonction, positionnez le bouton sur 0 .

UTILISER L'APPAREIL POUR LA PREMIÈRE FOIS

CHAUFFER LE FOUR

Un four neuf peut libérer des odeurs résultant de la fabrication : cela est totalement normal. Avant de commencer à faire cuire des aliments, nous recommandons donc de faire chauffer le four à vide afin d'éliminer les odeurs possibles.

Enlevez les cartons de protection ou les pellicules transparentes du four, et enlevez les accessoires qui se trouvent à l'intérieur.

Chauffez le four à 250 °C pour environ une heure. Le four doit être vide durant cette opération. Suivre les directives pour régler la fonction correctement.

Veillez noter : Nous vous conseillons d'aérer la pièce après avoir utilisé l'appareil pour la première fois.

UTILISATION QUOTIDIENNE

1. SÉLECTIONNER UNE FONCTION

Pour sélectionner une fonction, tournez le *bouton de sélection* sur le voyant de la fonction désirée.

2. ACTIVER UNE FONCTION

Pour lancer la fonction que vous avez sélectionnée, tournez le *bouton du thermostat* pour régler la température requise.

Pour interrompre la fonction en tout temps ou éteindre le four, tournez le *bouton de sélection* et le *bouton du thermostat* à 0 et 0.

3. PRÉCHAUFFAGE

Une fois la fonction activée, le voyant thermostat s'allume pour indiquer que le cycle de préchauffage est commencé.

À la fin du cycle, le voyant du thermostat s'éteint pour indiquer que le four a atteint la température désirée : vous pouvez maintenant placer les aliments à l'intérieur et débiter la cuisson.

Veillez noter : Placer les aliments dans le four avant la fin du préchauffage peut affecter la qualité de la cuisson.

• FONCTIONNEMENT DE LA TABLE DE CUISSON

(suivez les instructions qui accompagnent la table de cuisson).

Tournez le bouton de commande de la plaque chauffante sélectionnée dans le sens horaire jusqu'à la position désirée.



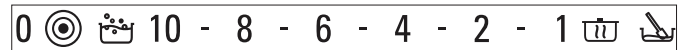



























































Le panneau de commandes du four présente 4 boutons réglables pour le fonctionnement de la table de cuisson. Les boutons de commande de la table de cuisson portent une échelle numérique correspondant à différentes puissances, ainsi qu'une série de symboles de fonction.









Veillez noter : La fonction Multizone n'est active qu'en correspondance des foyers double ou triple zone.











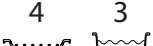

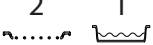



Tournez le bouton de commande de la plaque chauffante sélectionnée dans le sens horaire jusqu'à la position désirée.

TABLEAU DE CUISSON

RECETTE	FONCTION	PRÉCHAUF- FAGE	TEMPÉRATURE (°C)	DURÉE (Min.)	GRILLE ET ACCESSOIRES
Gâteaux à pâte levée		Oui	150 - 175	35 - 90	2 
		Oui	150 - 170	30 - 90	3 1  
Gâteaux garnis (gâteau au fromage, strudel, tarte aux pommes)		Oui	150 - 190	30 - 85	2 
		Oui	150 - 190	35 - 90	3 1  
Biscuits/Tartelettes		Oui	160 - 175	20 - 45	3 
		Oui	150 - 175	20 - 45	3 1  
Chouquettes		Oui	175 - 200	30 - 40	2 
		Oui	170 - 190	35 - 45	3 1  
Meringues		Oui	100	110 - 150	2 
		Oui	100	130 - 150	3 1  
Pain/Pizza/Fougasse		Oui	225 - 250	12 - 50	2 
		Oui	225 - 250	25 - 50	3 1  
Pizza surgelée		Oui	250	10 - 15	2 
		Oui	250	10 - 20	3 1  
Tartes salées (tartes aux légumes, quiches)		Oui	175 - 200	40 - 50	2 
		Oui	175 - 190	55 - 65	3 1  
Vol-au-vent/Feuilletés		Oui	175 - 200	20 - 30	2 
		Oui	175 - 200	25 - 45	3 1  
Lasagnes / pâtes cuites / cannelloni / tartes		Oui	200	45 - 65	2 
Agneau / veau / bœuf / porc 1 kg		Oui	200	80 - 110	2 
Poulet / lapin / canard 1 kg		Oui	200	50 - 100	2 
Dinde/oie 3 kg		Oui	200	80 - 130	1 / 2 
Poisson au four / en papillote (filet, entier)		Oui	175 - 200	40 - 60	2 
Légumes farcis (tomates, courgettes, aubergines)		Oui	175 - 200	50 - 60	2 
Rôtie		-	200	3 - 5	4 
Filets de poisson / biftecks		-	200	20 - 30	4 2  

FONCTIONS					
	Convection naturelle	Grill	Turbo Gril	Chaleur pulsée	Convection forcée











ACCESSOIRES					
	Grille métallique	Moule à gâteaux sur la grille métallique	Plaque de cuisson ou moule à gâteaux sur la grille métallique	Plaque de cuisson contenant 500 ml d'eau	Plaque de cuisson

RECETTE	FONCTION	PRÉCHAUFFAGE	TEMPÉRATURE (°C)	DURÉE (Min.)	GRILLE ET ACCESSOIRES
Saucisses / brochettes / côtes levées / hamburgers		-	200	30 - 40	4 3 
Poulet rôti 1 - 1,3 kg		-	200	55 - 70 *	2 1 
Rôti de bœuf saignant 1 kg		-	200	35 - 50 *	2 
Cuisse d'agneau / Jarrets		-	200	60 - 90 **	2 
Pommes de terre rôties		-	200	45 - 55 **	2 
Légumes gratinés		-	200	20 - 30	2 
Lasagnes & Viandes		Oui	200	50 - 100 ***	3 1 
Viandes & Pommes de terre		Oui	200	45 - 100 ***	3 1 
Poisson & légumes		Oui	175	30 - 50 ***	3 1 

* Tourner les aliments à mi-cuisson.

**Au besoin, retournez les aliments aux deux tiers de la cuisson).

*** Temps approximatif : les plats peuvent être retirés en tout temps, selon vos préférences personnelles.

FONCTIONS					
	Convection naturelle	Grill	Turbo Gril	Chaleur pulsée	Convection forcée
ACCESSOIRES					
	Grille métallique	Moule à gâteaux sur la grille métallique	Plaque de cuisson ou moule à gâteaux sur la grille métallique	Plaque de cuisson contenant 500 ml d'eau	Plaque de cuisson

TRUCS ET ASTUCES

COMMENT LIRE LE TABLEAU DE CUISSON

Le tableau indique la meilleure fonction, les accessoires, et le niveau à utiliser pour la cuisson des différents types d'aliments. Les temps de cuisson commencent au moment de l'introduction du plat dans le four et ne tiennent pas compte du préchauffage (s'il est nécessaire). Les températures et temps de cuisson sont approximatifs et dépendent de la quantité d'aliments et du type d'accessoire. Pour commencer, utilisez les valeurs conseillées les plus basses, et si les aliments ne sont pas assez cuits, augmentez-les. Utilisez les accessoires fournis, et de préférence des moules à gâteau en métal foncés et des plats de cuisson. Vous pouvez aussi utiliser des plaques et accessoires en pyrex ou en céramique ; cependant, les temps de cuisson seront sensiblement plus longs.

DESSERTS

Pour contrôler si un gâteau est cuit, introduisez un cure-dent en bois au centre du gâteau. Si le cure-dent ressort sec, le gâteau est cuit.

Si vous utilisez des moules antiadhésifs, ne beurrez pas les bords; le gâteau pourrait ne pas lever de manière homogène sur les bords. Si le gâteau « retombe » durant la cuisson, sélectionnez une température inférieure la fois suivante. Vous pouvez également réduire la quantité de liquide ou mélanger la pâte plus délicatement.

VIANDE

Utilisez tout type de plat à four ou plat en pyrex adapté à la taille du morceau de viande à cuire. Pour les rôtis, il est conseillé d'ajouter du bouillon dans le plat et d'arroser la viande durant la cuisson pour la rendre plus savoureuse. Veuillez noter que de la vapeur est produite durant cette opération. Lorsque le rôti est cuit, laissez-le reposer dans le four 10 à 15 minutes ou enveloppez-le dans du papier aluminium. Si vous désirez faire griller de la viande, choisissez des morceaux de la même épaisseur pour obtenir une cuisson uniforme. Les morceaux de viande très épais demandent un temps de cuisson plus long. Pour éviter de brûler la viande sur les côtés, abaissez la grille pour éloigner la nourriture du gril. Retournez la viande aux deux tiers de la cuisson. Au moment d'ouvrir la porte, faites attention à la vapeur chaude qui s'échappe. Nous vous conseillons de placer une lèchefrite avec un demi-litre d'eau directement en dessous de la grille sur laquelle la viande est placée pour recueillir le jus de cuisson. Ajoutez de l'eau si nécessaire.

PIZZA

Graissez légèrement les plaques pour obtenir une pizza avec une pâte croustillante. Répartissez la mozzarella sur la pizza aux deux tiers de la cuisson.

NETTOYAGE ET ENTRETIEN

Assurez-vous que le four ait refroidi avant tout entretien ou nettoyage.

N'utilisez pas de nettoyeur à vapeur.

N'utilisez pas de laine d'acier, de tampons à récurer abrasifs, ou des détergents abrasifs ou corrosifs, ils pourraient endommager les surfaces de l'appareil.

Utilisez des gants de protection. L'appareil doit être débranché de l'alimentation principale avant d'effectuer des travaux d'entretien.

NETTOYAGE DES SURFACES EXTÉRIEURES

Nettoyez les surfaces à l'aide d'un chiffon en microfibre humide.

Si elles sont très sales, ajoutez quelques gouttes de détergent à pH neutre. Essuyez avec un chiffon sec. N'utilisez pas de détergents corrosifs ou abrasifs. Si l'un de ces produits entre en contact avec des surfaces de l'appareil, nettoyez immédiatement à l'aide d'un chiffon en microfibre humide.

NETTOYAGE DES SURFACES INTÉRIEURES

Après chaque utilisation, laissez le four refroidir et nettoyez-le, de préférence lorsqu'il est encore tiède, pour enlever les dépôts ou taches laissés par les résidus de nourriture. Pour enlever la condensation qui se serait formée lors de la cuisson d'aliments avec une forte teneur en eau, laissez le four refroidir complètement et essuyez-le avec un chiffon ou une éponge.

Nettoyez le verre dans la porte avec un détergent liquide approprié.

La porte du four peut être enlevée pour faciliter le nettoyage.

NETTOYAGE DES ACCESSOIRES

Faire tremper les accessoires dans de l'eau contenant un détergent à vaisselle après les avoir utilisés; utilisez des gants de cuisine s'ils sont encore chauds. Utilisez une brosse à vaisselle ou une éponge pour enlever les résidus d'aliments.

REPLACEMENT DE L'AMPOULE

1. Débranchez le four de l'alimentation électrique.

2. Dévissez le couvercle de l'ampoule, remplacez l'ampoule, et revissez le couvercle.

3. Rebranchez le four à l'alimentation électrique.

Veillez noter : Utiliser uniquement des ampoules halogènes de 20-40W/230 V type G9, T300°C. L'ampoule utilisée dans l'appareil est spécialement conçue pour les appareils électroménagers et ne convient pas pour l'éclairage d'une pièce de la maison (Règlement CE 244/2009). Ces ampoules sont disponibles auprès de notre Service après-vente. Ne manipulez pas les ampoules à halogène à mains nues, les traces laissées par vos empreintes pourraient les endommager. Avant d'utiliser le four, assurez-vous que le couvercle de l'ampoule a bien été remis en place.

ENLEVER ET RÉINSTALLER LA PORTE

1. Pour enlever la porte, ouvrez-la complètement et abaissez les loquets jusqu'à qu'ils soient déverrouillés.

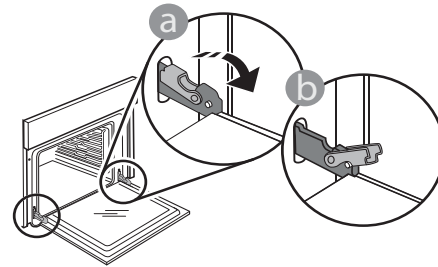

2. Fermez le plus possible la porte. Tenez la porte fermement avec les deux mains – ne la tenez pas par la poignée. Enlevez simplement la porte en continuant à la fermer tout en la tirant vers le haut jusqu'à ce qu'elle soit dégagée de ses appuis. Placez la porte de côté, l'appuyant sur une surface souple.

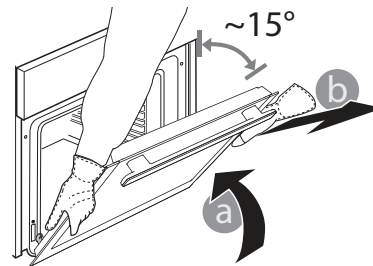

3. Réinstallez la porte en la plaçant devant le four pour aligner les crochets des charnières avec leurs appuis, et insérez la partie supérieure sur son appui.

4. Abaissez la porte pour ensuite l'ouvrir complètement. Abaissez les loquets dans leur position originale : Assurez-vous de les abaisser complètement.

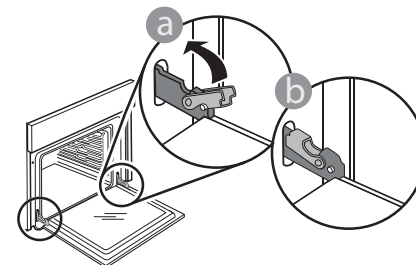

Appliquez une légère pression pour vous assurer que les loquets sont bien placés.

5. Essayez de fermer la porte et assurez-vous qu'elle est alignée avec le panneau de commande. Sinon, répétez les étapes précédentes : La porte pourrait s'endommager si elle ne fonctionne pas correctement.

Problème	Cause possible	Solution
Le four ne fonctionne pas.	Coupure de courant. Débranchez de l'alimentation principale.	Assurez-vous qu'il n'y a pas de panne de courant et que le four est bien branché. Éteignez puis rallumez le four pour voir si le problème persiste.

FICHE TECHNIQUE

 **www** La fiche technique, incluant les taux d'efficacité énergétique du four, peut être téléchargée sur notre site Web **docs.bauknecht.eu**

COMMENT OBTENIR LE GUIDE D'UTILISATION ET ENTRETIEN

>  **www** Téléchargez le Guide d'utilisation et d'entretien sur notre site Web **docs.bauknecht.eu** (vous pouvez utiliser ce code QR), en précisant le code commercial du produit.



> Une autre façon est de contacter notre Service Après-vente.

CONTACTER LE SERVICE APRÈS-VENTE

Vous pouvez trouver les informations pour nous contacter dans le livret de garantie. Lorsque vous contactez notre Service Après-vente, veuillez indiquer les codes disponibles sur la plaque signalétique de l'appareil.

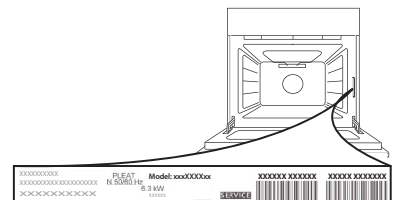

GUIDA RAPIDA



GRAZIE PER AVERE ACQUISTATO UN PRODOTTO BAUKNECHT

Per ricevere un'assistenza più completa, registrare il prodotto su www.bauknecht.eu/register



Scaricare le istruzioni per la sicurezza e le istruzioni per l'uso collegandosi al sito docs.bauknecht.eu e seguire la procedura indicata sul retro.

! Leggere attentamente le istruzioni per la sicurezza prima di utilizzare il prodotto.

DESCRIZIONE PRODOTTO

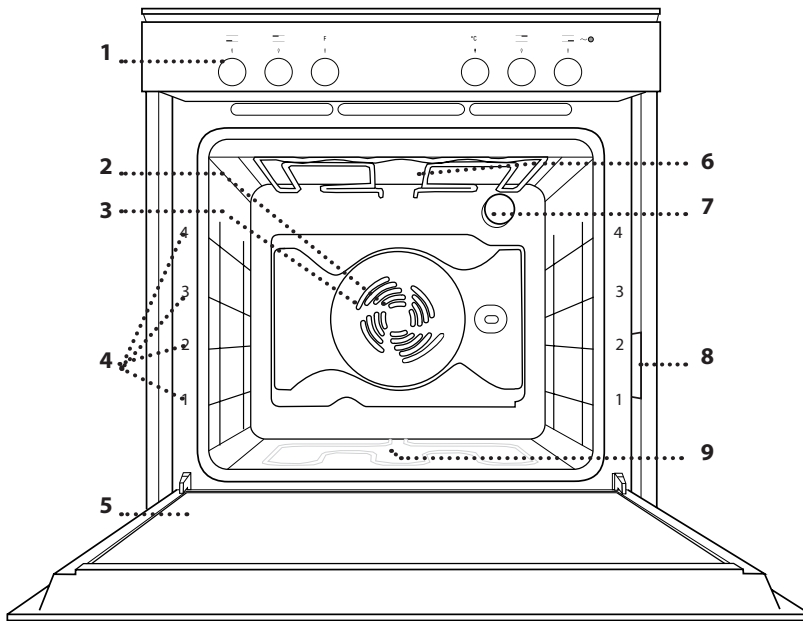

1. Pannello di controllo
2. Ventola
3. Resistenza circolare (non visibile)
4. Griglie laterali (il livello è indicato sulla parte frontale del forno)
5. Porta
6. Resistenza superiore / grill
7. Lampada
8. Targhetta matricola (da non rimuovere)
9. Resistenza inferiore (non visibile)

PANNELLO DI CONTROLLO

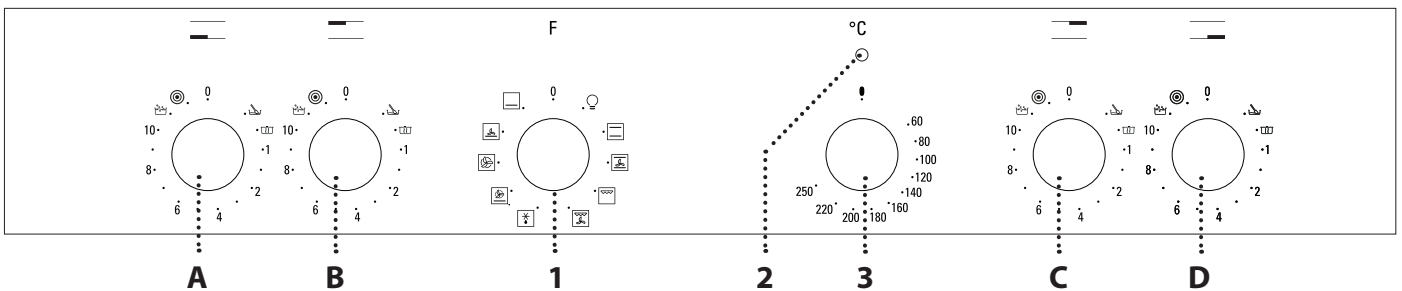

COMANDI FORNO

1. MANOPOLA DI SELEZIONE

Per accendere il forno selezionando una funzione. Per spegnere il forno, ruotare sulla posizione 0.

2. SPIA TERMOSTATO/PRERISCALDAMENTO

Si accende durante la fase di riscaldamento. Si spegne al raggiungimento della temperatura desiderata.

3. MANOPOLA TERMOSTATO

Ruotare per selezionare la temperatura desiderata.

CONTROLLI PIANO COTTURA

- A. per zona di cottura anteriore sinistra.
- B. per zona di cottura posteriore sinistra.
- C. per zona di cottura posteriore destra.
- D. per zona di cottura anteriore destra.

ACCESSORI

GRIGLIA

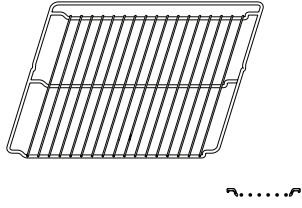

TEGLIA

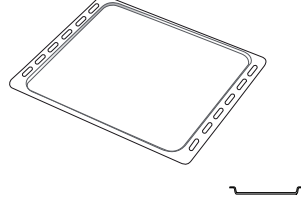

Il numero e il tipo di accessori possono variare a seconda del modello acquistato. È possibile acquistare separatamente altri accessori non in dotazione presso il Servizio Assistenza Clienti.

INSERIRE LA GRIGLIA E ALTRI ACCESSORI

Inserire la griglia orizzontalmente facendola scivolare sulle griglie laterali inserendo dapprima il lato rialzato orientato verso l'alto.

Gli altri accessori, come la teglia, vanno inseriti orizzontalmente allo stesso modo.

TOGLIERE E RIMONTARE LE GRIGLIE LATERALI

- Per rimuovere le griglie, togliere le viti di fissaggio (se presenti) da entrambi i lati con l'aiuto di una moneta o di un attrezzo adatto. Quindi sollevare le guide ed estrarre le parti inferiori dai relativi alloggiamenti: a questo punto è possibile rimuovere le griglie.
- Per rimontare le griglie, inserirle dapprima nelle sedi superiori. Avvicinarle alla cavità tenendo sollevato, quindi abbassarle in posizione nelle sedi inferiori. Rimontare le viti di fissaggio.

FUNZIONI FORNO

0 OFF
Per spegnere il forno.

LAMPADA
Per accendere/spegnere la luce del forno.

STATICO
Per cuocere qualsiasi tipo di pietanza su un solo ripiano.

VENTILATO
Per cuocere carni o torte con ripieno liquido su un solo ripiano.

GRILL
Per grigliare costate, spiedini e salsicce, gratinare verdure o dorare il pane. Per la grigliatura delle carni, si consiglia di utilizzare una leccarda per raccogliere il liquido di cottura: posizionarla un livello sotto la griglia e aggiungere 500 ml di acqua potabile.

TURBO GRILL
Per arrostitire grossi pezzi di carne (cosciotti, roast beef, polli). Si consiglia di utilizzare una teglia per raccogliere il liquido di cottura: posizionarla un livello sotto la griglia e aggiungere 500 ml di acqua potabile.

SCONGELAMENTO
Per velocizzare lo scongelamento degli alimenti. Disporre gli alimenti sul ripiano intermedio. Si suggerisce di lasciare l'alimento nella sua confezione per impedire che si asciughi eccessivamente all'esterno.

TURBOVENTILATO
Per ottenere cibi con una base croccante e una superficie soffice. Ideale per cuocere su singolo livello torte con composto liquido senza base precotta. Si consiglia di disporre gli alimenti sul 2° ripiano. Questa funzione è ideale anche per piatti pronti surgelati. Seguire le istruzioni riportate sulla confezione del prodotto.

TERMOVENTILATO
Per cuocere contemporaneamente al massimo su due ripiani alimenti, anche diversi, che richiedono la medesima temperatura di cottura (ad esempio pesce, verdure, dolci). La funzione permette di cuocere senza trasmissione di odori da un alimento all'altro.

FONDO VENTILATO
Per terminare la cottura di pietanze a consistenza molto liquida e ottenere basi croccanti e dorate. Utile anche per concentrare salse e sughi. Si consiglia di disporre gli alimenti sul 2° ripiano.

RESISTENZA INFERIORE
Per dorare il fondo della pietanza alla fine di una cottura. Tale funzione può essere utilizzata anche per la cottura lenta carne o per cuocere stufati. Si consiglia di riporre il cibo sul 1°/ 2° livello di cottura.

TABELLA FUNZIONI PIANO DI COTTURA

0 OFF
Per spegnere la piastra.

TEPORE

Per far lievitare la pasta, ammorbidire il burro tolto dal frigo, mantenere al caldo i biberon o la pappa dei bambini, per preparare lo yogurt, sciogliere il cioccolato, ecc. La funzione è disponibile soltanto con la spia del calore residui accesa. Per il funzionamento, accertarsi che la spia di calore residuo della zona di cottura che si desidera utilizzare sia accesa. Ruotare la manopola su . Per disattivare questa funzione, cambiare la posizione della manopola.

MANTENIMENTO CALORE

Per mantenere la temperatura costante a 60° fino a fine cottura. Per selezionare questa funzione, ruotare la manopola su .

EBOLLIZIONE RAPIDA

Per portare rapidamente l'acqua ad ebollizione; questa funzione resta attiva per un tempo prestabilito. Allo scadere del tempo, il piano di cottura ritorna automaticamente sul livello di potenza massimo. Può essere attivata anche a cottura già iniziata. Importante: Prima di attivare questa funzione, accertarsi di aver messo la pentola sulla zona di cottura prescelta per evitare di danneggiare la superficie del piano. I valori di prestazione specificati per questa funzione sono garantiti per tutti i piani di cottura vetroceramici. Per il funzionamento, mettere la pentola sulla zona di cottura prescelta e ruotare la manopola su . Disattivare cambiando la posizione della manopola.

MULTIZONA

È disponibile sulle piastre anteriore sinistra e posteriore sinistra. Allarga l'area di riscaldamento del piano per permettere l'uso di pentole grandi, ovali o rettangolari. Per selezionare questa funzione: ruotare la manopola su  e aspettare che la spia di calore residuo corrispondente alla piastra inizi a lampeggiare. Per azionare la zona tripla (se disponibile), attendere fino a quando il LED inizia a lampeggiare velocemente. Selezionare il livello di potenza richiesta ruotando la manopola in senso antiorario. La spia di calore residuo resta accesa per indicare che il piano di cottura è inserito. Per deselezionare il livello di potenza, ruotare in senso antiorario la manopola su **0**.

PRIMO UTILIZZO

RISCALDARE IL FORNO

Un forno nuovo può rilasciare odori che costituiscono residui della sua fabbricazione: ciò è completamente normale.

Prima di iniziare a cucinare gli alimenti, si consiglia pertanto di riscaldare il forno quando è ancora vuoto per eliminare l'eventuale presenza di odori.

Rimuovere protezioni di cartone o pellicole trasparenti e togliere gli accessori dal forno.

Riscaldare il forno a 250°C per circa un'ora.

Durante questa procedura il forno deve essere vuoto. Seguire le istruzioni a seguire per impostare la funzione nel modo corretto.

Note: è opportuno ventilare la stanza durante e dopo il primo utilizzo.

USO QUOTIDIANO

1. SELEZIONARE UNA FUNZIONE

Per selezionare una funzione, ruotare la *manopola di selezione* in corrispondenza del simbolo della funzione desiderata.

2. AVVIARE UNA FUNZIONE

Per avviare la funzione selezionata, ruotare la *manopola termostato* per impostare la temperatura desiderata.

Per interrompere una funzione in qualsiasi momento, spegnere il forno, ruotare la *manopola di selezione* e la *manopola del termostato* su 0 e ●.

3. PRERISCALDAMENTO

Quando si attiva questa funzione, la spia del termostato si accende per segnalare l'inizio della fase di preriscaldamento.

Alla fine del processo, la spia del termostato si spegne per indicare che il forno ha raggiunto la temperatura impostata: a questo punto, inserire gli alimenti e procedere alla cottura.

Note: inserire gli alimenti nel forno prima della fine del preriscaldamento può compromettere i risultati di cottura.

• FUNZIONAMENTO DEL PIANO COTTURA

(vedere le istruzioni fornite con il piano cottura).

Ruotare in senso orario la manopola di comando della zona di cottura interessata fino a selezionare l'impostazione di potenza richiesta.



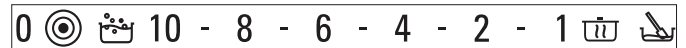



























































Il pannello comandi del forno è dotato di 4 manopole regolabili che controllano il funzionamento del piano. Le manopole comando del piano cottura sono contrassegnate da una scala numerica corrispondente ai differenti livelli di potenza e da una serie di simboli di funzione.































Note: è possibile disattivare la funzione multizona soltanto su piani dotati da zona di cottura doppia e tripla.

Ruotare in senso orario la manopola di comando della zona di cottura interessata fino a selezionare l'impostazione di potenza richiesta.

TABELLA DI COTTURA

RICETTA	FUNZIONE	PRERISC.	TEMPERATURA (°C)	DURATA (Min.)	RIPIANO E ACCESSORI
Torte a lievitazione		Sì	150 - 175	35 - 90	2 
		Sì	150 - 170	30 - 90	3 1  
Torte ripiene (torta di ricotta, strudel, torta di mele)		Sì	150 - 190	30 - 85	2 
		Sì	150 - 190	35 - 90	3 1  
Biscotti / Crostatine		Sì	160 - 175	20 - 45	3 
		Sì	150 - 175	20 - 45	3 1  
Bignè		Sì	175 - 200	30 - 40	2 
		Sì	170 - 190	35 - 45	3 1  
Meringhe		Sì	100	110 - 150	2 
		Sì	100	130 - 150	3 1  
Pane / Pizza / Focaccia		Sì	225 - 250	12 - 50	2 
		Sì	225 - 250	25 - 50	3 1  
Pizza surgelata		Sì	250	10 - 15	2 
		Sì	250	10 - 20	3 1  
Torte salate (torta di verdure, quiche)		Sì	175 - 200	40 - 50	2 
		Sì	175 - 190	55 - 65	3 1  
Vols-au-vent / Salatini di pasta sfoglia		Sì	175 - 200	20 - 30	2 
		Sì	175 - 200	25 - 45	3 1  
Lasagne / Pasta al forno / Cannelloni / Sformati		Sì	200	45 - 65	2 
Agnello / Vitello / Manzo / Maiale (1 kg)		Sì	200	80 - 110	2 
Pollo / Coniglio / Anatra 1 kg		Sì	200	50 - 100	2 
Tacchino / Oca (3 kg)		Sì	200	80 - 130	1/2 
Pesce al forno / al cartoccio (filetti, intero)		Sì	175 - 200	40 - 60	2 
Verdure ripiene (pomodori, zucchine, melanzane)		Sì	175 - 200	50 - 60	2 
Toast		-	200	3 - 5	4 
Filetti/Tranci di pesce		-	200	20 - 30	4 2  











FUNZIONI					
	Statico	Grill	Turbo Grill	Termoventilato	Ventilato
ACCESSORI					
	Griglia	Tortiera su griglia	Piastra dolci o tortiera su griglia	Piastra dolci con 500 ml di acqua	Piastra dolci

RICETTA	FUNZIONE	PRERISC.	TEMPERATURA (°C)	DURATA (Min.)	RIPIANO E ACCESSORI
Salsicce / Spiedini / Costine / Hamburger		-	200	30 - 40	4 3 
Pollo arrosto 1-1,3 kg		-	200	55 - 70 *	2 1 
Roast beef al sangue 1 kg		-	200	35 - 50 *	2 
Cosciotto d'agnello/Stinco		-	200	60 - 90 **	2 
Patate arrosto		-	200	45 - 55 **	2 
Verdure gratinate		-	200	20 - 30	2 
Lasagne e carne		Sì	200	50 - 100 ***	3 1 
Carne e patate		Sì	200	45 - 100 ***	3 1 
Pesce e verdure		Sì	175	30 - 50 ***	3 1 

* Ruotare il cibo a metà cottura.

** Ruotare il cibo a due terzi di cottura se necessario.

*** La durata è approssimata: le pietanze possono essere tolte dal forno in tempi differenti secondo preferenza.

FUNZIONI	 Statico	 Grill	 Turbo Grill	 Termoventilato	 Ventilato
ACCESSORI	 Griglia	 Tortiera su griglia	 Piastra dolci o tortiera su griglia	 Piastra dolci con 500 ml di acqua	 Piastra dolci

SUGGERIMENTI E CONSIGLI

COME LEGGERE LA TABELLA DI COTTURA

La tabella indica la funzione, gli accessori e il livello migliore da utilizzare per cuocere svariati tipi di cibo. I tempi di cottura si riferiscono all'introduzione del cibo nel forno, escluso il preriscaldamento (dove richiesto). Le temperature e i tempi di cottura sono indicativi e dipendono dalla quantità di cibo e dal tipo di accessori. Utilizzare inizialmente i valori più bassi consigliati e, se il risultato della cottura non è quello desiderato, passare a quelli più alti. Si consiglia di utilizzare gli accessori in dotazione e tortiere o teglie possibilmente in metallo scuro. È possibile utilizzare anche pentole e accessori in pirex o in ceramica, i tempi di cottura si allungheranno leggermente.

DOLCI

Per capire se la torta a lievitazione è cotta, inserire uno stecchino di legno nella parte più alta del dolce. Se lo stuzzicadenti rimane asciutto, il dolce è pronto. Se si utilizzano tortiere antiaderenti, non imburrare i bordi; il dolce potrebbe non crescere uniformemente su tutti i lati. Se il dolce si "sgonfia" durante la cottura, la volta successiva utilizzare una temperatura inferiore, magari riducendo la quantità di liquido e mescolando più delicatamente l'impasto.

CARNE

Utilizzare qualunque tipo di teglia o pirofila adatta alle dimensioni della carne da cuocere. Per gli arrosti, aggiungere preferibilmente del brodo sul fondo della pirofila inumidendo la carne durante la cottura per insaporirla. Fare attenzione al vapore che si sviluppa durante tale operazione. Quando l'arrosto è pronto, lasciarlo riposare in forno per altri 10-15 minuti oppure avvolgerlo in un foglio di alluminio. Per la cottura uniforme della carne alla griglia, scegliere tagli dello stesso spessore. I pezzi di carne molto spessi richiedono tempi di cottura più lunghi. Per evitare che si brucino in superficie, allontanarli dal grill disponendoli su ripiani più bassi. Girare la carne a due terzi della cottura. Aprire con cautela la porta in quanto può fuoriuscire vapore caldo. Si consiglia di posizionare una leccarda con mezzo litro d'acqua potabile direttamente sotto la griglia sulla quale avete posizionato il cibo da grigliare, per raccogliere il liquido di cottura. Rabboccare se necessario.

MULTICRISP

Ungerne leggermente le teglie per ottenere una pizza croccante anche sul fondo. Distribuire la mozzarella sulla pizza a due terzi della cottura.

PULIZIA E MANUTENZIONE

Assicurarsi che il forno si sia raffreddato prima di eseguire ogni operazione.

Non utilizzare pulitrici a getto di vapore.

Non usare pagliette metalliche, panni abrasivi e detergenti abrasivi o corrosivi che possano danneggiare le superfici.

Utilizzare guanti protettivi.
Il forno deve essere disconnesso dalla rete elettrica prima di effettuare operazioni di manutenzione.

PULIZIA DELLE SUPERFICI ESTERNE

Pulire le superfici con un panno in microfibra umido. Se molto sporche, aggiungere qualche goccia di detergente neutro. Asciugare con un panno asciutto. Non usare detergenti corrosivi o abrasivi. Se inavvertitamente uno di questi prodotti dovesse venire a contatto con le superfici, pulire subito con un panno in microfibra umido.

PULIZIA DELLE SUPERFICI INTERNE

Dopo ogni uso, lasciare raffreddare il forno e pulirlo preferibilmente quando è ancora tiepido per rimuovere incrostazioni e macchie dovute a residui di cibo. Per asciugare la condensa dovuta alla cottura di alimenti ad alto contenuto di acqua, usare a forno freddo un panno o una spugna. Pulire i vetri della porta con detergenti liquidi specifici. Per facilitare la pulizia della porta è possibile rimuoverla.

PULIZIA DEGLI ACCESSORI

Mettere a bagno gli accessori con detersivo per piatti dopo l'uso, maneggiandoli con guanti da forno, se ancora caldi. I residui di cibo possono essere rimossi con una spazzola per piatti o con una spugna.

SOSTITUZIONE DELLA LAMPADINA

1. Scollegare il forno dalla rete elettrica.
2. Svitare la copertura della lampada, sostituire la lampada e avvitarla di nuovo il coperchio della lampada.
3. Ricollegare il forno alla rete elettrica.

Note: Utilizzare soltanto lampade alogene da 20-40 W/230 V tipo G9 per temperature da 300°C. La lampada utilizzata nel prodotto è specifica per elettrodomestici e non è adatta per l'illuminazione di ambienti domestici (Regolamento (CE) 244/2009). Le lampade sono disponibili presso il Servizio Assistenza.

In caso di impiego di lampade alogene, non maneggiarle a mani nude, per evitare che vengano danneggiate dalle impronte digitali. Non far funzionare il forno senza prima aver riposizionato il coperchio.

TOGLIERE E RIMONTARE LA PORTA

1. Per rimuovere la porta, aprirla completamente e abbassare i fermi fino alla posizione di sblocco.

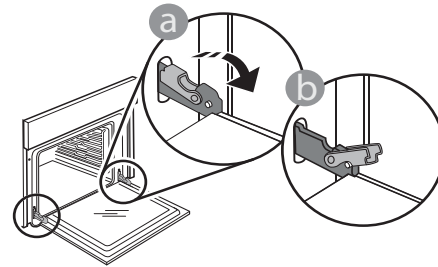

2. Chiudere la porta fino a quando è possibile. Prendere saldamente la porta con entrambe le mani, evitando di tenerla per la maniglia. Per estrarla facilmente, continuare a chiuderla e contemporaneamente tirarla verso l'alto finché non esce dalle sedi. Togliere la porta e appoggiarla su un piano morbido.

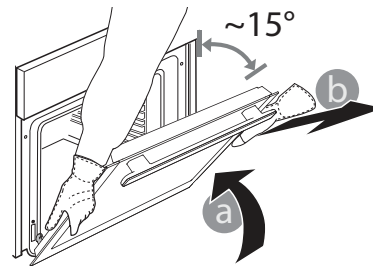

3. Per rimontare la porta, avvicinarla al forno allineando i ganci delle cerniere alle proprie sedi e ancorare la parte superiore agli alloggiamenti.
4. Abbassare la porta e poi aprirla completamente. Abbassare i fermi nella posizione originale: fare attenzione che siano completamente abbassati.

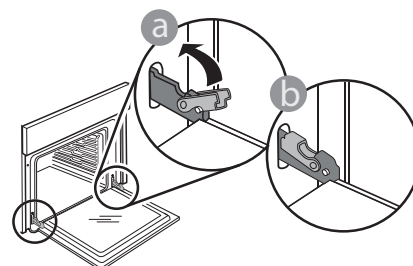

Sarà necessario applicare una leggera pressione per assicurare il corretto posizionamento dei fermi.

5. Provare a chiudere la porta, verificando che sia allineata al pannello di controllo. Se non lo fosse, ripetere tutte le operazioni: funzionando male, la porta potrebbe danneggiarsi.

Problema	Possibile causa	Soluzione
Il forno non funziona.	Interruzione di corrente elettrica. Disconnessione dalla rete principale.	Verificare che ci sia tensione in rete e che il forno sia collegato all'alimentazione elettrica. Spegnere e riaccendere il forno e verificare se l'inconveniente persiste.

SCHEDA TECNICA

 La scheda tecnica del prodotto comprensiva dei dati energetici di questo forno può essere scaricata dal sito internet docs.bauknecht.eu

COME OTTENERE LE ISTRUZIONI PER L'USO

>  Scaricare le Istruzioni per l'uso dal sito web docs.bauknecht.eu (è possibile utilizzare questo codice QR) specificando il codice prodotto.



> In alternativa, contattare il Servizio di Assistenza Clienti.

CONTATTARE IL SERVIZIO ASSISTENZA CLIENTI

I contatti possono essere trovati sul manuale di garanzia. Quando si contatta il Servizio Assistenza fornire i codici presenti sulla targhetta matricola del prodotto.

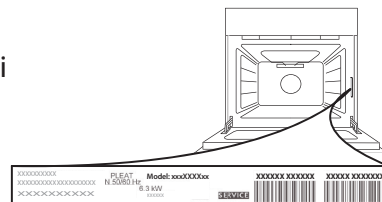

400011713698