

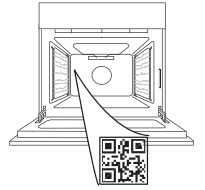

**THANK YOU FOR BUYING A WHIRLPOOL PRODUCT**  
 In order to receive a more complete assistance, please register your product on [www.whirlpool.eu/register](http://www.whirlpool.eu/register)

**PLEASE SCAN THE QR CODE ON YOUR APPLIANCE IN ORDER TO REACH MORE INFORMATION**



Before using the appliance carefully read the Safety Instruction.

## PRODUCT DESCRIPTION

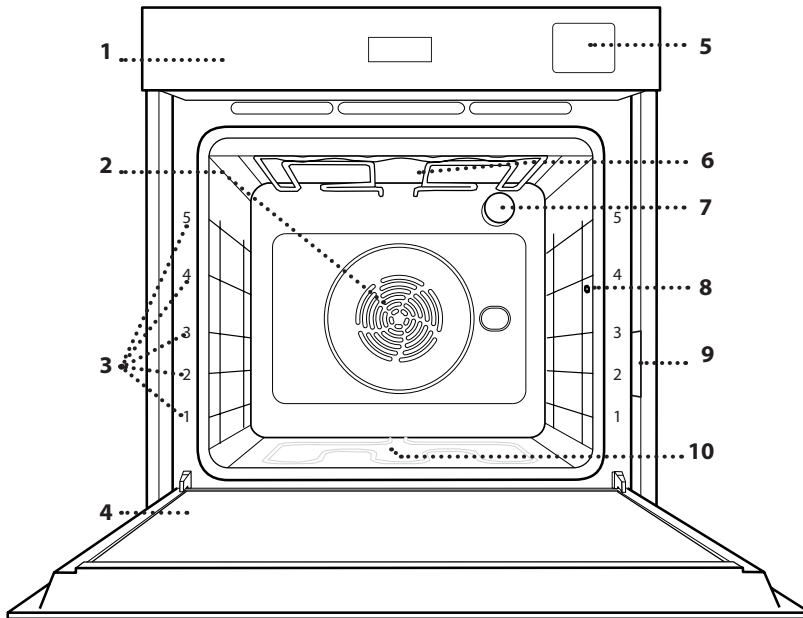

1. Control panel
2. Fan and circular heating element (non-visible)
3. Shelf guides (the level is indicated on the front of the oven)
4. Door
5. Water drawer
6. Upper heating element/grill
7. Lamp
8. Food probe insert point
9. Identification plate (do not remove)
10. Lower heating element (non-visible)

## CONTROL PANEL

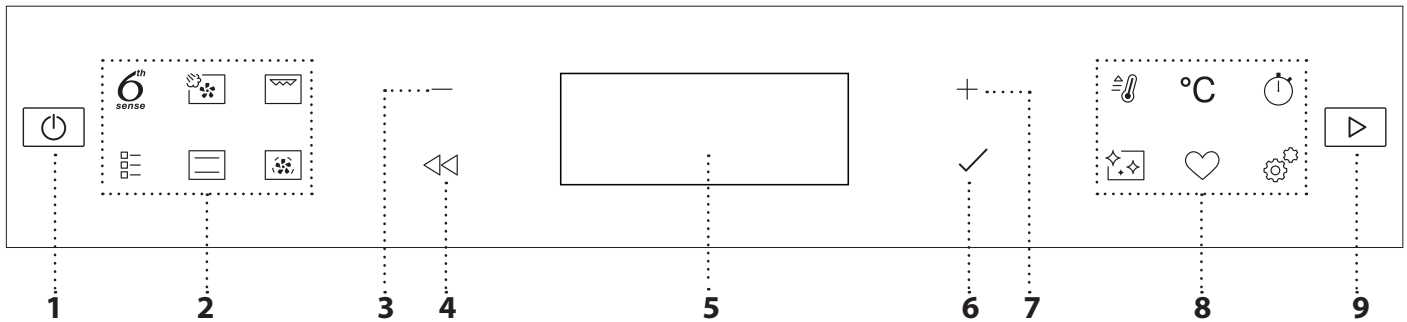

### 1. ON / OFF

For switching the oven on and off and for stopping an active function.

### 2. FUNCTIONS DIRECT ACCESS

For quick access to the functions and menu.

### 3. NAVIGATION BUTTON MINUS

For scrolling through a menu and decreasing the settings or values of a function.

### 4. BACK

For returning to the previous screen. During cooking, allows settings to be changed.

### 5. DISPLAY

### 6. CONFIRM

For confirming a selected function or a set value.

### 7. NAVIGATION BUTTON PLUS

For scrolling through a menu and increasing the settings or values of a function.

### 8. OPTIONS / FUNCTIONS DIRECT ACCESS

For quick access to the functions, duration, settings and favorites.

### 9. START

For starting a function using the specified or basic settings.

# ACCESSORIES

## WIRE SHELF

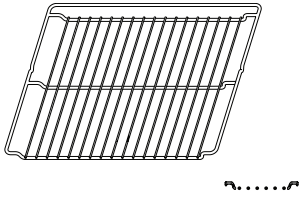

Use to cook food or as a support for pans, cake tins and other ovenproof items of cookware.

## DRIP TRAY

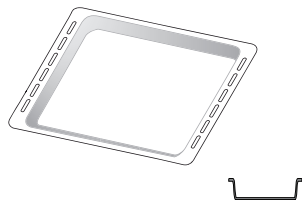

Use as an oven tray for cooking meat, fish, vegetables, focaccia, etc. or position underneath the wire shelf to collect cooking juices.

## BAKING TRAY

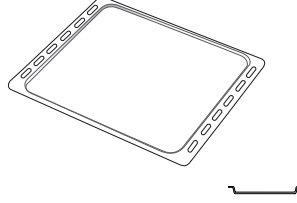

Use for cooking all bread and pastry products, but also for roasts, fish en papillote, etc.

## SLIDING RUNNERS

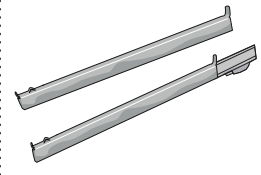

To facilitate inserting or removing accessories.

## FOOD PROBE

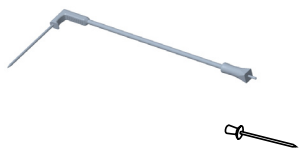

To accurately measure the core temperature of food during cooking. Thanks to its rigid support, it can be used for meat and fish, and also for bread, cakes and baked pastries.

## AIR FRY TRAY \*

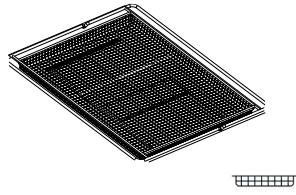

To be used when cooking foods with Air Fry function, with a baking tray positioned at a lower level to collect possible crumbs and drip. It can be cleaned in the dishwasher.

The number and the type of accessories may vary depending on which model is purchased. Other accessories can be purchased separately; for orders and information contact the after sales service.  
\* Available only in certain models

## INSERTING THE WIRE SHELF AND OTHER ACCESSORIES

Insert the wire shelf horizontally by sliding it across the shelf guides, making sure that the side with the raised edge is facing upwards.

Other accessories, such as the drip tray and the baking tray, are inserted horizontally in the same way as the wire shelf.

## REMOVING AND REFITTING THE SHELF GUIDES

- To remove the shelf guides, lift them up and pull the lower parts out of their lodgings: The shelf guides can now be removed.

- To refit the shelf guides, first fit them back into their upper seating. Keeping them held up, slide them into the cooking compartment, then lower them into position in the lower seating.

## FITTING THE SLIDING RUNNERS

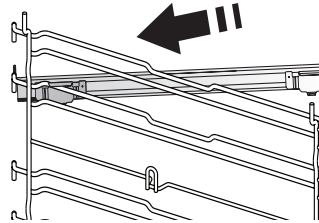

Remove the shelf guides from the oven and remove the protective plastic from the sliding runners.

Fasten the upper clip of the runner to the shelf guide and slide it along as far as it will go. Lower the other clip into position.

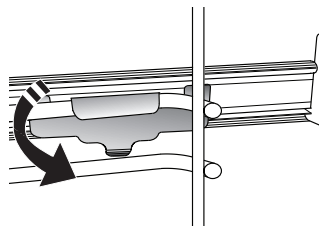

To secure the guide, press the lower portion of the clip firmly against the shelf guide. Make sure that the runners can move freely. Repeat these steps on the other shelf guide on the same level.

Please note: The sliding runners can be fitted on any level.

# FUNCTIONS



## 6TH SENSE

These allow a fully automatic cooking for all types of food (Lasagna, Meat, Fish, Vegetables, Cakes & Pastries, Salt cakes, Bread, Pizza). To get the best from this function, follow the indications on the relative cooking table.



## STEAM + AIR

Combining the properties of steam with those of the forced air, this function allows you to cook dishes pleasantly crispy and browned outside, but at the same time tender and succulent inside. To achieve the best cooking results, we recommend to select a LEVEL 3 steam for fish cooking, LEVEL 2 steam for meat and LEVEL 1 for bread and desserts.

For more information on forced air + steam manual cooking cycles head to the "Steam + Air" Cooking Table.



## GRILL

For grilling steaks, kebabs and sausages, cooking vegetables au gratin or toasting bread. When grilling meat, we recommend using a drip tray to collect the cooking juices: Position the tray on any of the levels below the wire shelf and add 500 ml of drinking water.



## TRADITIONAL FUNCTIONS

### • CONVECT BAKE

For cooking any kind of dish on one shelf only.

### • COOK4

For cooking different foods that require the same cooking temperature on four levels at the same time. This function can be used to cook cookies, cakes, round pizzas (also frozen) and to prepare a complete meal. Follow the cooking table to obtain the best results.

### • TURBO GRILL

For roasting large joints of meat (legs, roast beef, chicken). We recommend using a drip tray to collect the cooking juices: Position the pan on any of the levels below the wire shelf and add 500 ml of drinking water.

### • FROZEN BAKE

The function automatically selects the ideal cooking temperature and mode for 5 different types of ready frozen food. The oven does not have to be preheated.

### • SPECIAL FUNCTIONS

#### » PIZZA

This function allows you to cook great homemade pizza, in less than 10 minutes like in a restaurant.

The dedicated cooking cycle works at temperature level above 300 degree Celsius, delivering pizza soft inside, crunchy on the edges and with a perfectly even browning.

Combining this function with the Pizza Stone WPro accessory and preheating for 30 minutes can bake a pizza in 5-8 min.

(For orders and information contact the after sales service or [www.whirlpool.eu](http://www.whirlpool.eu))

#### » AIR FRY

This function allows you to cook French fries, chicken nuggets and more using less oil, resulting pleasantly crispy. Heating elements cycle to properly heat the cavity, while the fan circulates hot air. Best expected cooking results can be achieved only by using an Air Fry tray (provided with some models). Position the food on the Air Fry tray in a single layer and follow Air Fry Cooking Table instructions for best performances. Avoid using more than one tray to prevent uneven cooking.

#### » RISING

For optimal proving of sweet or savoury dough. To maintain the quality of proving, do not activate the function if the oven is still hot following a cooking cycle.

#### » KEEP WARM

For keeping just-cooked food hot and crisp.

#### » DEFROST

To speed up defrosting of food. Place food on the middle shelf. Leave food in its packaging to prevent it from drying out on the outside.

#### » ECO CYCLE

For cooking stuffed roasting joints and fillets of meat on a single shelf. When this Eco Cycle is in use, the light will remain switched off during cooking. To use the Eco Cycle and therefore optimise power consumption, the oven door should not be opened until the food is completely cooked.

#### » MAXI COOKING

The function automatically selects the best cooking mode and temperature to cook large joints of meat (above 2.5 kg). It is advisable to turn the meat over during cooking, to obtain even browning on both sides. It is best to baste the meat every now and again to prevent it from drying out.



## CONVENTIONAL

For cooking any kind of dish on one shelf only.



## FORCED AIR

For cooking different foods that require the same cooking temperature on several shelves (maximum three) at the same time. This function can be used to cook different foods without odours being transferred from one food to another.

---

 **FAST PREHEAT**

For preheating the oven quickly.

 **MINUTE-MINDER**

For keeping time without activating a function.

 **CLEANING**

- **PYRO**

For eliminating cooking spatters using a cycle at very high temperature. Two self cleaning cycles are available: A complete cycle (Pyro) and a shorter cycle (Pyro Eco). We recommend using the complete cycle to experience the best cleaning performance.

- **SMARTCLEAN**

The action of the steam released during this special low-temperature cleaning cycle allows dirt and food residues to be removed with ease. Pour 200 ml of drinking water on the bottom of the oven and only activate the function when the oven is cold.

- **DESCALE**

For removing limescale deposits from the boiler. We recommend using this function at regular intervals. If you do not, a message will appear on the display reminding you to clean the oven.

**FAVORITES**

For retrieving the list of 10 favorite functions.

**SETTINGS**

For adjusting the oven settings. When "ECO" mode is active the brightness of the display will be reduced to save energy and lamp switches off after 1 minute. It will be reactivated automatically whenever any of the buttons are pressed. When "DEMO" is "On" all commands are active and menus available but the oven doesn't heat up. To deactivate this mode, access "DEMO" from "SETTINGS" menu and select "Off". By selecting "FACTORY RESET", the product switches off and then it returns to first switch on. All settings will be deleted.

# FIRST TIME USE

## 1. SELECT THE LANGUAGE

You will need to set the language and the time when you switch on the appliance for the first time: "English" will show on the display.



Press  $+$  or  $-$  to scroll through the list of available languages and select the one you require. Press  $\checkmark$  to confirm your selection.

Please note: The language can subsequently be changed by selecting "LANGUAGE" in "SETTINGS" menu, available by pressing

## 2. SET THE POWER CONSUMPTION

The oven is programmed to consume a level of electrical power that is compatible with a domestic network that has a rating of more than 3 kW (16): If your household uses a lower power, you will need to decrease this value (13).



Press  $+$  or  $-$  to select 16 "High" or 13 "Low" and press  $\checkmark$  to confirm.

## 3. SET THE TIME

After selecting the language, you will need to set the current time: The two digits for the hour will flash on the display.



Press  $+$  or  $-$  to set the correct hour and press  $\checkmark$ : The two digits for the minutes will flash on the display. Press  $+$  or  $-$  to set the minutes and press  $\checkmark$  to confirm.

Please note: You may need to set the time again following lengthy power outages. Select "CLOCK" in "SETTINGS" menu, available by pressing

## 4. SET THE WATER HARDNESS LEVEL

In order to allow the oven to work efficiently, and to guarantee that it regularly prompts the user to perform Descale cycle when needed, it is important to set the correct water hardness level. To set it, switch on the oven by pressing , press Settings and use navigation buttons  $+$  and  $-$  to select "WATER HARDNESS". Press  $\checkmark$  to confirm. Use navigation buttons  $+$  and  $-$  to select the correct level for the water of your area, based on the following table:

WATER HARDNESS LEVELS TABLE				
Level		°dH German degrees	°fH French degrees	°Clark English degrees
1	Very soft	0-6	0-10	0-7
2	Soft	7-11	11-20	8-14
3	Mid	12-16	21-29	15-20
4	Hard	17-34	30-60	21-42
5	Very hard	35-50	61-90	43-62

Press  $\checkmark$  to confirm.

For Water Hardness level, "Hard" is preset.

## 5. HEAT THE OVEN

A new oven may release odours that have been left behind during manufacturing: This is completely normal.

Before starting to cook food, we therefore recommend heating the oven with it empty in order to remove any possible odours. Remove any protective cardboard or transparent film from the oven and remove any accessories from inside it. Heat the oven to 200 °C for around one hour, ideally using a function with air circulation (e.g. "Forced Air" or "Convection Bake").

Please note: It is advisable to air the room after using the appliance for the first time.

# DAILY USE

## 1. SELECT A FUNCTION

Press  to switch on the oven: the display will show the last running main function or the main menu.

The functions can be selected by pressing the icon for one of the main functions or by scrolling through a menu: To select an item from a menu (the display will show the first available item), press  $+$  or  $-$  to select the desired one, then press  $\checkmark$  to confirm.

## 2. SET THE FUNCTION

After having selected the function you require, you can change its settings. The display will show the settings that can be changed in sequence. Pressing  $\lll$  allows you to change the previous setting again

### TEMPERATURE / GRILL LEVEL / STEAM LEVEL

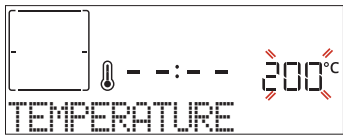

When the value flashes on the display, press  $+$  or  $-$  to change it, then press  $\checkmark$  to confirm and continue with the settings that follow (if possible).



In the same way, it is possible to set the grill level: There are three defined power levels for grilling: 3 (high), 2 (mid), 1 (low).

In "Forced Air + Steam" function, you can select the amount of steam from the following values: STEAM 1, STEAM 2.

Please note: Once the function has been activated, the temperature/grill level can be changed using  $+$  or  $-$ .

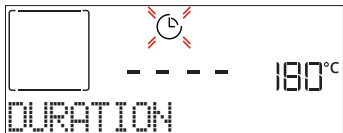
### DURATION



When the  icon flashes on the display, press  $+$  or  $-$  to set the cooking time you require and then press  $\checkmark$  to confirm. You do not have to set the cooking time if you want to manage cooking manually (untimed): Press  $\checkmark$  or  to confirm and start the function. By selecting this mode, you cannot program a delayed start.

Please note: You can adjust the cooking time that has been set during cooking by pressing : press  $+$  or  $-$  to amend it and then press  $\checkmark$  to confirm.

### END TIME (START DELAY)

In many functions, once you have set a cooking time you can delay starting the function by programming its end time. The display shows the end time while the  icon flashes.



Press  $+$  or  $-$  to set the time you want cooking to end, then press  $\checkmark$  to confirm and activate the

function. Place the food in the oven and close the door: The function will start automatically after the period of time that has been calculated in order for cooking to finish at the time you have set.

Please note: Programming a delayed cooking start time will disable the oven preheating phase: The oven will reach the temperature you require gradually, meaning that cooking times will be slightly longer than those listed in the cooking table. During the waiting time, you can press  $+$  or  $-$  to amend the programmed end time or press  $\lll$  to change other settings. By pressing , in order to visualize information, it is possible to switch between end time and duration.

### . 6<sup>TH</sup> SENSE

These functions automatically select the best cooking mode, temperature and duration to cook, roast or bake all the dishes available.

When required, simply indicate the characteristic of food to obtain an optimal result.

### WEIGHT / HEIGHT (ROUND-TRAY-LAYERS)



To set the function correctly, follow the indications on the display, when prompted, and press  $+$  or  $-$  to set the required value then press  $\checkmark$  to confirm.

### DONENESS / BROWNING

In some 6<sup>th</sup> Sense functions it is possible to adjust the doneness level.

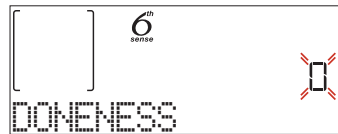

When prompted, press  $+$  or  $-$  to select the desired level between rare (-1) and well done (+1). Press  $\checkmark$  or  to confirm and start the function.

In the same way, where allowed, in some 6<sup>th</sup> Sense functions, it's possible to adjust the browning level between low (-1) and high (+1).

### . COOKING WITH STEAM

By selecting the "Steam" or "Forced Air + Steam" inside the Manual Functions or one of the several 6<sup>th</sup> Sense dedicated recipes it is possible cook any kind of food thanks to the use of the steam. Steam spreads more quickly and more evenly through food compared to just the hot air typical of Conventional Functions: this reduce cooking times, locking in food's precious nutrients and ensuring you obtain excellent, truly delicious results with all your recipes. Through the complete duration of the steam cooking the door must be kept closed.

To proceed with steam cooking, it will be necessary to provide water to the boiler located inside the oven using the extractable drawer on the control panel.

When requested on the display with "ADD WATER"

indications, extract the drawer, open drawer's lid and fill it with water until the level requested on the display. Close the drawer by pushing it carefully towards the panel until completely closed. After the drawer insertion, press START to proceed with the cooking cycle. The drawer must always remain closed, except for water filling.

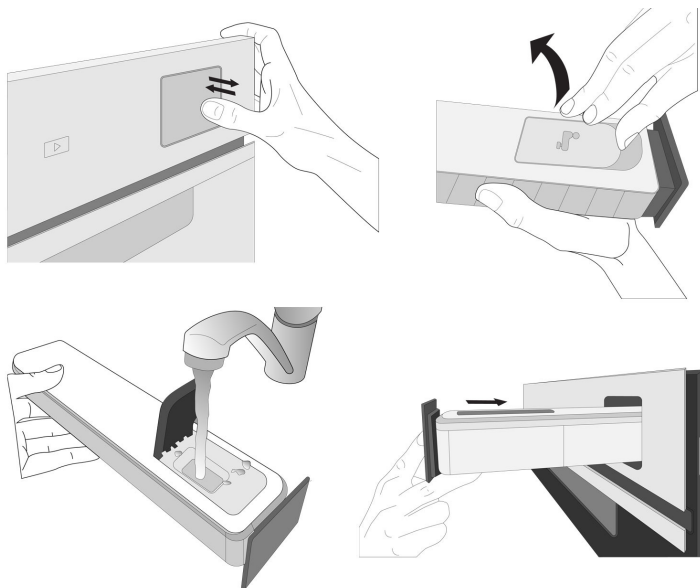

After the first filling, in case of longer cooking cycles, once water will have ran out, it could be necessary to add it again, in order to complete the cycle: the oven will prompt it in case it is needed.

### 3. START THE FUNCTION

At any time, if the default values are those desired or once you have applied the settings you require, press to activate the function.

During the delay phase, by pressing the oven will ask if you want to skip this phase, starting immediately the function.

Please note: Once a function has been selected, the display will recommend the most suitable level for each function. At any time you can stop the function that has been activated by pressing .

If the oven is hot and the function requires a specific maximum temperature, a message will shown on the display. You can either select a different function or wait for a complete cooling.

### 4. PREHEATING

Some functions have an oven preheating phase: Once the function has started, the display indicates that the preheating phase has been activated.

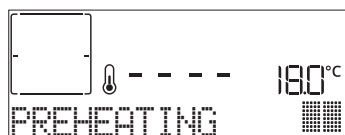

Once this phase has finished, an audible signal will sound and the display will indicate that the oven has reached the set temperature, requiring to "ADD FOOD". At this point, open the door, place the food in the oven, close the door and start cooking by pressing or .

Please note: Placing the food in the oven before preheating has finished may have an adverse effect on the final cooking result. Opening the door during the preheating phase will stop pause it.

The cooking time does not include a preheating phase. You can always change the temperature you want the oven to reach using  $+$  or  $-$ .

### 5. TURN OR CHECK FOOD

Some 6th Sense functions will require the food to be turned during cooking.



An audible signal will sound and the display shows the action to be done. Open the door, do the action prompted by the display and close the door, then press to continue cooking.

In the same way, at 10% of time before the end of cooking, the oven prompts you to check the food.



An audible signal will sound and the display shows the action to be done. Check the food, close the door and press or to continue cooking.

Please note: Press to skip these actions. Otherwise, if no action is done after a certain time the oven will continue the cooking.

### 6. END OF COOKING

An audible signal will sound and the display will indicate that cooking is complete.

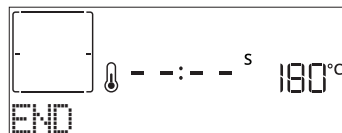

Press to continue cooking in manual mode (untimed) or press  $+$  to extend the cooking time by setting a new duration. In both cases, the cooking parameters will be retained.

### BROWNING

Some functions of the oven enable you to brown the surface of the food by activating the grill once cooking is complete.



When the display shows the relevant message, if required press to start a five-minute browning cycle. You can stop the function at any time by pressing to switch the oven off.

### . FAVORITES

Once cooking is complete the display will prompt you to save the function in a number between 1 and 10

on your list of favorites.



If you would like to save a function as a favorite and store the current settings for future use, press ✓ otherwise, to ignore the request press <<<.

Once ✓ has been pressed, press the + or - to select the number position, then press ✓ to confirm.

Please note: If the memory is full or the number chosen has already been taken, the oven will ask you to confirm overwriting the previous function.

To call up the functions you have saved at a later time, press ♥ : The display will show your list of favorite functions.



Press + or - to select the function, confirm by pressing ✓, and then press ▶ to activate.

## . CLEANING

### • PYRO

**Do not touch the oven during the Pyro cycle. Keep children and animals away from the oven during and after (until the room has finished airing) running the Pyro cycle.**

Remove all accessories - including shelf guides - from the oven before activating the function. If the oven is installed below a hob, make sure that all the burners or electric hotplates are switched off while running the selfcleaning cycle. For optimum cleaning results, remove the worst soiling with a damp sponge before using the Pyro function. We recommend only running the Pyro function if the appliance contains heavy soiling or gives off bad odours during cooking.

Press ✨ to show "Pyro" on the display.

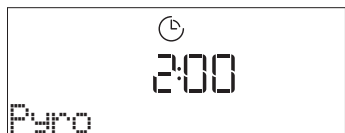

Press + or - to select the desired cycle, then press ✓ to confirm. Once a cycle has been selected, if desired, press + or - to set end time (start delay), then press ✓ to confirm.

Clean the door and remove all accessories as prompted, then close the door and press ▶ when done: the oven will begin the self-cleaning cycle, while the door locks automatically: a warning message appears on the display, along with a countdown indicating the status of the cycle in progress.

Once the cycle has been completed, the door remains locked until the temperature inside the oven has

returned to a safe level.

### • SMARTCLEAN

Press ✨ to show "Smart Clean" on the display.

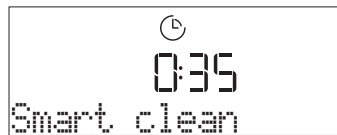

Press ▶ to activate the function: the display will prompt you to do all actions needed to obtain the best cleaning results: Follow the indications and then press ✓ when done. Once you have done all steps, when required press ▶ to activate the cleaning cycle.

Please note: It is recommended to do not open the oven door during the cleaning cycle to avoid a loss of water vapor that could get an adverse effect on the final cleaning result.

An appropriate message will start flashing on the display once the cycle has finished. Leave the oven to cool and then wipe and dry the interior surfaces with a cloth or sponge.

## . DRAIN

The drain function allows the water to be drained in order to prevent stagnation in the boiler. This product has been developed in order to automatically run a drain cycle once cooking has been stopped/has ended.

Approximately 30min after the stop/end of cooking, the oven will automatically drain the system, moving the residual water in the drawer (be careful not to remove the drawer after cooking). Once done, the drawer can be extracted and emptied. We recommend emptying the drawer as soon as the drain is completed.

## . DESCALE

This special function, activated at regular intervals, allows you to keep the steam system in the best condition. Once the function is started, follow all the steps indicated on the display. The average duration of the full function is around 140 minutes.

Descal can be initiated anytime by the user from the Cleaning Menu.

The display will show you when it is time to run a Descal cycle (see the table below).

DESCALE MESSAGE	MEANING
<DESCALE RECOMMENDED> It appears after around 15 hours of steam cycles*	It is recommended to run a Descal cycle.
<DESCALE NEEDED> It appears after around 20 hours of steam cycles*	Descal is mandatory. It is not possible to run a Steam cycle until a Descal cycle will be carried out.

\*considering the default value (4 - Hard) of water hardness level. The number of hours of steam cycles that must pass before the Decale messages are shown



depends on the water hardness level set on the appliance.

The descaling procedure can also be performed whenever the user desires a deeper cleaning of the internal steam circuit.

Before to run the descaling phase, the appliance will check if some residual water is contained into the boiler, and a Drain cycle could be performed, if needed. In this case, you will have to empty the drawer after the Drain cycle, before continuing with the Descal Phase.

Please note: to ensure that the water is cold, it is not possible to perform this activity before 30 minutes have elapsed from the last cycle (or the last time the product was powered). During this waiting time, the display will show the following feedback "WATER IS HOT".

#### » PHASE 1/2: DESCALING (70 MIN)

When display will show <ADD 0.25 L OF SOLUTION>, please pour the descaling solution in the drawer. For best results in descaling, we recommend filling the tank with a solution composed of 75 g of the specific WPRO product and 250 ml of drinking water. WPRO descaler is the suggested professional product for the maintenance of the best performance of your steam function in the oven. For orders and information contact the after sales service or [www.whirlpool.eu](http://www.whirlpool.eu).

Whirlpool will not be held responsible for any damage caused by the use of other cleaning products available on the market.

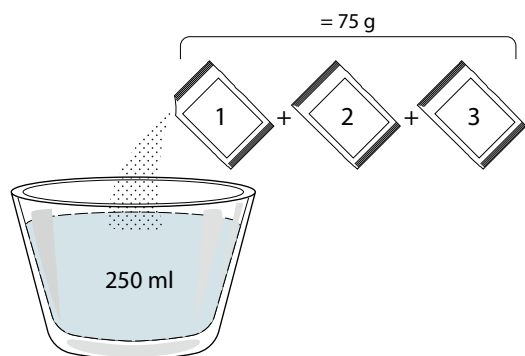

Once the descaling solution is poured inside the drawer, press to start the main descaling process. The descaling phases do not need you to stay in front of the appliance. After each phase is completed, an acoustical feedback will be played and the display will show instructions to proceed with the next phase.

Once the descaling phase has been completed, the boiler will be drained: the descaling solution used during this phase will be poured into the extractable drawer.

#### » PHASE 2/2: RINSING (30 MIN.)

To remove descale residuals from the drawer and the steam circuit, rinse cycle has to be done. When display shows <ADD 0.25 L OF WATER> fill the tank with 0,25 L of drinking water, then press to start the rinsing. Do not turn off the oven until all the steps

required by the function have been completed.

Please note: if needed from the system, it could be requested to empty the drawer and to repeat this operation.

When Descal procedure is completed, it is suggested to dry the cavity from potential water residuals. It will be then possible to use all the steam functions.

Please note: during the Descal cycle, some noise could potentially be heard since the oven pumps are activated in order to guarantee the optimal descale efficiency.

Once the maintenance cycle has started, do not remove the drawer unless requested by the appliance.

Please note: After the boiler gets filled by the descaling solution and the display shows "DESCALING PHASE 1/2", the cycle should not be interrupted, otherwise the entire descaling cycle must be repeated before being able to run any steam function.

#### . MINUTEMINDER

To activate this function press the icon. Press  $+$  or  $-$  to set the length of time you require and then press to activate the timer.

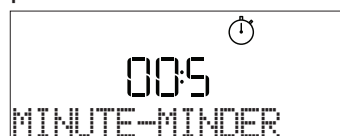

An audible signal will sound and the display will indicate once the minuteminder has finished counting down the selected time.

Please note: The minuteminder does not activate any of the cooking cycles.

The minute minder can be activated also when a function is running.

The timer will continue to count down independently without interfering with the function itself.

During this phase, it isn't possible to see the minuteminder (only the icon will be displayed), that will continue counting down in background. To edit the minuteminder you can press the icon and set the time using the  $+$  or  $-$  icon.

To cancel the minuteminder, press the icon, then select  $-$  until the time displayed is "--:--". Press to confirm.

#### . KEYLOCK

To lock the keypad, press and hold for at least five seconds. Do this again to unlock the keypad.

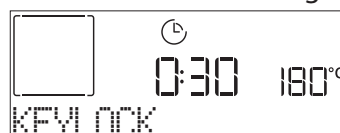

Please note: This function can also be activated during cooking. For safety reasons, the oven can be switched off at any time by pressing .

## • USING THE FOOD PROBE (IF PRESENT)

Using the probe enables you to measure the core temperature of the different food types during cooking to ensure that it reaches the optimum temperature. The temperature of the oven varies according to the function that you have selected, but cooking is always programmed to finish once the specified temperature has been reached.

Once you have inserted the probe, an audible signal is activated and "Probe Plugged" appears on the display.



Select the function you require from those that are compatible (Conventional, Forced Air, Convection Bake, Turbogrill, Eco Forced Air, Maxi Cooking, 6<sup>th</sup> Sense functions): The display prompts to set the target temperature of the probe: Press  $+$  or  $-$  to set it and press  $\checkmark$  to set the following cooking parameters.

As cooking is programmed to finish once the required temperature has been reached, it is not possible to set the cooking time or set a specific time for cooking to end. The light will remain switched on until the probe is removed.

If the probe is removed during cooking, it will continue by the traditional mode (untimed).

An audible signal will sound and the display will indicate when the probe has reached the required temperature.

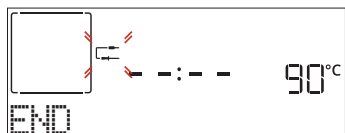

Please note: To change the settings subsequently, press  $+$  or  $-$  for the probe temperature or press  $\llcorner$  for other settings. An audible signal and a message will tell you if use of the probe is not compatible with the action done. If this is the case, remove the probe.

Place the food in the oven and connect the plug by inserting it into the connection provided on the righthand side of the oven's cooking compartment.

The cable is semi-rigid and can be shaped as needed to insert the probe into different food types in the most effective way. Make sure that the cable does not touch the top heating element during cooking.

**MEAT:** Insert the probe deep into the meat, avoiding bones or fatty areas. For poultry, insert the probe lengthways into the centre of the breast, avoiding hollow areas.

**FISH (whole):** Position the tip in the thickest part, avoiding the thorns.

**BAKERY & PASTA:** Insert the tip deep into the dough by shaping the cable to achieve the optimum probe angle.

It is required to use the compatible 6<sup>th</sup> Sense functions in order to perform a probe controlled cooking for these food types. If you use the probe when cooking with the 6<sup>th</sup> Sense functions, cooking will be stopped automatically when the selected recipe reaches the ideal core temperature, without the need to set the oven temperature.

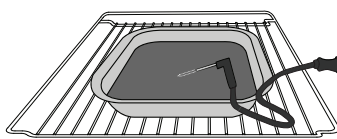

Lasagna

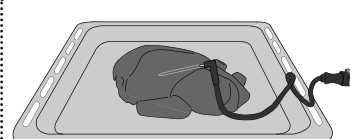

Whole Chicken

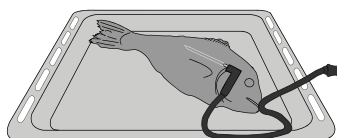

Fish

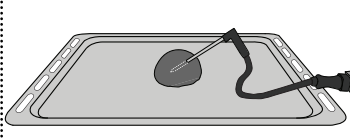

Rolls

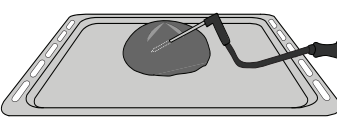

Big Bread

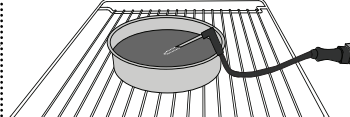

Cake

## • NOTES

- Do not cover the inside of the oven with aluminium foil.
- Never drag pots or pans across the bottom of the oven as this could damage the enamel coating.
- Do not place heavy weights on the door and do not hold on to the door.

---

## USEFUL TIPS

---

### HOW TO READ THE COOKING TABLE

The table lists the best function, accessories and level to use to cook different types of food. Cooking times start from the moment food is placed in the oven, excluding preheating (where required). Cooking temperatures and times are approximate and depend on the amount of food and the type of accessory used. Use the lowest recommended settings to begin with and, if the food is not cooked enough, then switch to higher settings. Use the accessories supplied and preferably dark-coloured metal cake tins and baking trays. You can also use Pyrex or stoneware pans and accessories, but bear in mind that cooking times will be slightly longer.

---

### COOKING DIFFERENT FOODS AT THE SAME TIME

Using the "Forced Air" function, you can cook different foods which require the same cooking temperature at the same time (for example: fish and vegetables), using different shelves. Remove the food which requires a shorter cooking time and leave the food which requires a longer cooking time in the oven.

---

### MEAT

Use any kind of oven tray or pyrex dish suited to the size of the piece of meat being cooked. For roast joints, it is best to add some stock to the bottom of the dish, basting the meat during cooking for added flavour. Please note that steam will be generated during this operation. When the roast is ready, let it rest in the oven for another 10-15 minutes, or wrap it in aluminium foil.

When you want to grill meat, choose cuts with an even thickness all over in order to achieve uniform cooking results. Very thick pieces of meat require longer cooking times. To prevent the meat from burning on the outside, lower the position of the wire shelf, keeping the food farther away from the grill. Turn the meat two thirds of the way through cooking. Take care when opening the door as steam will escape.

To collect the cooking juices, we recommend placing a dripping pan filled with half a litre of drinking water directly underneath the wire shelf on which the food is placed. Top-up when necessary.

### DESSERTS

Cook delicate desserts with the conventional function on one shelf only.

Use dark-coloured metal baking pans and always place them on the wire shelf supplied. To cook on more than one shelf, select the forced air function and stagger the position of the cake tins on the shelves, aiding optimum circulation of the hot air.

To check whether a leavened cake is cooked, insert a wooden toothpick into the centre of the cake. If the toothpick comes out clean, the cake is ready.

If using non-stick baking pans, do not butter the edges as the cake may not rise evenly around the edges.



















































If the item "swells" during baking, use a lower temperature next time and consider reducing the amount of liquid you add or stirring the mixture more gently.

For desserts with moist fillings or toppings (such as cheesecake or fruit tarts), use the "Convection bake" function. If the base of the cake is soggy, lower the shelf and sprinkle the bottom of the cake with breadcrumbs or biscuit crumbs before adding the filling.





---





























### RISING

It is always best to cover the dough with a damp cloth before placing it in the oven. Dough proving time with this function is reduced by approximately one third compared to proving at room temperature (20-25°C). The rising time for pizza starts at around one hour for 1 kg of dough.





FOOD CATEGORIES		QUANTITY	DONENESS LEVEL	BROWNING LEVEL	TURN (OF COOK TIME)	LEVEL AND ACCESSORIES	
LASAGNA	Lasagna	0.5 - 3 kg*	-	0	-	 	
MEAT	Beef	Roast 	0.6 - 2 kg*	0	0	-	 
		Burger	1.5 - 3 cm	0	-	3/5	 
		Roast - Slow cooking	0.6 - 2 kg*	0	-	-	 
	Pork	Roast 	0.6 - 2.5 kg*	-	0	-	 
		Shank 	0.5 - 2.0 kg*	-	0	-	 
		Sausages & Wurstel	1.5 - 4.5 cm	-	-	2/3	 
	Veal 		0.6 - 2.5 kg*	-	0	-	 
	Lamb	Roast 	0.6 - 2.5 kg*	0	0	-	 
		Leg 	0.5 - 2.0 kg*	0	0	-	 
	Poultry	Roast Chicken 	0.6 - 3 kg*	-	0	-	 
		Whole - stuffed 	0.6 - 3 kg*	-	0	-	 
		Fillet & Breast	1 - 5 cm	-	-	2/3	 
Whole Turkey		0.6 - 3 kg*	-	0	-	 	
Kebabs		one grid	-	-	1/2	 	
FISH	Fillets	0.5 - 3 (cm)	-	-	-	 	
	Fillets - frozen	0.5 - 3 (cm)	-	-	-	 	
VEGETABLES	Roasted vegetables	Roasted Potatoes	0.5 - 1.5 kg	-	0	-	
		Stuffed Vegetables	0.1 - 0.5 kg [each]	-	-	-	
		Roasted Vegetables	0.5 - 1.5 kg	-	0	-	
	Gratin Vegetables	Potatoes Gratin	one tray	-	-	-	
		Tomatoes Gratin	one tray	-	-	-	
		Peppers Gratin	one tray	-	-	-	
		Broccoli Gratin	one tray	-	-	-	
		Cauliflower Gratin	one tray	-	-	-	
Vegetables Gratin	one tray	-	-	-			

\* Suggested quantity

ACCESSORIES					
	Wire shelf	Oven tray / Cake tray / Round pizza tray on wire shelf	Drip tray / Baking tray	Drip tray with 500 ml of water	Food Probe

FOOD CATEGORIES		QUANTITY	DONENESS LEVEL	BROWNING LEVEL	TURN (OF COOK TIME)	LEVEL AND ACCESSORIES	
SALTY BAKERY	Salty cake	0.8 - 1.2 kg	-	0	-	2 	
	Bread	Bread Rolls 	60 - 150g [each]*	-	-	-	3 
		Sandwich Loaf 	400 - 600 g [each]	-	-	-	2 
		Big Bread 	0.7 - 2.0kg *	-	-	-	2 
		Baguettes 	200 - 300g [each]*	-	-	-	3 
	Pizza	Round Pizza	round	-	-	-	2 
		Thick Pizza	tray	-	-	-	2 
		Pizza [frozen]	1 layer*	-	-	-	2 
			2 layers*	-	-	-	4  1 
			3 layers*	-	-	-	5  3  1 
4 layers*	-		-	-	5  4  2  1 		
SWEET BAKERY	Sponge Cake	0.5 - 1.2 kg*	-	-	-	2  	
	Cookies	0.2 - 0.6 kg	-	-	-	3 	
	Choux Pastry	one tray*	-	-	-	3 	
	Tart	0.4 - 1.6kg	-	-	-	3 	
	Strudel	0.4 - 1.6kg	-	-	-	3 	
	Fruit rising cake	0.5 - 1.2 kg*	-	-	-	2  	

\* Suggested quantity

ACCESSORIES					
	Wire shelf	Oven tray / Cake tray / Round pizza tray on wire shelf	Drip tray / Baking tray	Drip tray with 500 ml of water	Food Probe



# AIR FRY COOKING TABLE

	RECIPE	FUNCTION	SUGGESTED QUANTITY	PREHEAT	TEMPERATURE (°C)	DURATION (MIN.)	SHELF AND ACCESSORIES
FROZEN FOOD	Frozen French Fries		650 - 850g	Yes	200	25 - 30	4  2
	Frozen Chicken Nugget		500g	Yes	200	15 - 20	4  2
	Fish Sticks		500g	Yes	220	15 - 20	4  2
	Onion Rings		500g	Yes	200	15 - 20	4  2
VEGETABLES	Fresh Breaded Zucchini		400g	Yes	200	15 - 20	4  2
	Homemade Fries		300 - 800 g	Yes	200	20 - 40	4  2
	Mixed Vegetables		300 - 800 g	Yes	200	20 - 30	4  2
MEAT AND FISH	Chicken Breasts		1 - 4 cm	Yes	200	20 - 40	4  2
	Chicken Wings		200 - 1500 g	Yes	220	30 - 50	4  2
	Breaded Cutlet		1 - 4 cm	Yes	220	20 - 50	4  2
	Fish Fillet		1 - 4 cm	Yes	220	15 - 25	4  2

For cooking fresh or homemade foods, spread a thin layer of oil across the food surface.  
In order to guarantee uniform cooking results, mix food halfway through the recommended cooking time.

FUNCTIONS	 Air Fry		
ACCESSORIES	 Air Fry tray	 Oven tray or cake tray on wire shelf	 Drip tray / Baking tray or oven tray on wire shelf





















































































# STEAM + AIR COOKING TABLE













RECIPE	STEAM LEVEL*	PREHEAT	TEMPERATURE (°C)	DURATION (MIN.)	SHELF AND ACCESSORIES
Shortbread / Cookies	1	YES	140 - 150	35 - 55	3
Small cake / Muffin	1	YES	160 - 170	30 - 40	3
Leavened cakes	1	YES	170 - 180	40 - 60	2
Sponge cakes	1	YES	160 - 170	30 - 40	2
Focaccia	1	YES	200 - 220	20 - 40	3
Bread loaf	1	YES	170 - 180	70 - 100	3
Small bread	1	YES	200 - 220	30 - 50	3
Baguette	1	YES	200 - 220	30 - 50	3
Roast potatoes	2	YES	200 - 220	50 - 70	3
Veal / Beef / Pork 1 kg	2	YES	180 - 200	60 - 100	3
Veal / Beef / Pork (pieces)	2	YES	160 - 180	60 - 80	3
Roast Beef rare 1 kg	2	YES	200 - 220	40 - 50	3
Roast Beef rare 2 kg	2	YES	200	55 - 65	3
Leg of lamb	2	YES	180 - 200	65 - 75	3
Stew pork knuckles	2	YES	160 - 180	85 - 100	3
Chicken / guinea fowl / duck 1 - 1.5 kg	2	YES	200 - 220	50 - 70	3
Chicken / guinea fowl / duck (pieces)	2	YES	200 - 220	55 - 65	3
Stuffed vegetables (tomatoes, courgettes, aubergines)	2	YES	180 - 200	25 - 40	3
Fish fillet	3	YES	180 - 200	15 - 30	3

\*Please consider the In case of selecting Steam Auto function this correlation must be skipped. The oven will automatically select the best level of steam suited for the temperature selected.

ACCESSORIES	 Oven tray or cake tray on wire shelf	 Drip tray / Baking tray or oven tray on wire shelf
-------------	--	--

# COOKING TABLE

RECIPE	FUNCTION	PREHEAT	TEMPERATURE (°C)	DURATION (MIN.)	SHELF AND ACCESSORIES
Leavened cakes / Sponge cakes		Yes	170	30 - 50	
		Yes	160	30 - 50	
		Yes	160	30 - 50	 
Filled cakes (cheesecake, strudel, apple pie)		Yes	160 - 200	30 - 85	
		Yes	160 - 200	30 - 90	 
Cookies		Yes	150	20 - 40	
		Yes	140	30 - 50	
		Yes	140	30 - 50	 
		Yes	135	40 - 60	  
Small cakes / Muffin		Yes	170	20 - 40	
		Yes	150	30 - 50	
		Yes	150	30 - 50	 
		Yes	150	40 - 60	  
Choux buns		Yes	180 - 200	30 - 40	
		Yes	180 - 190	35 - 45	 
		Yes	180 - 190	35 - 45 *	  
Meringues		Yes	90	110 - 150	
		Yes	90	130 - 150	 
		Yes	90	140 - 160 *	  
Pizza / Bread / Focaccia		Yes	190 - 250	15 - 50	
		Yes	190 - 230	20 - 50	  
Pizza (Thin, thick, focaccia)		Yes	310	7 - 12	
		Yes	220 - 240	25 - 50 *	  
Frozen pizza		Yes	250	10 - 15	
		Yes	250	10 - 20	 
		Yes	220 - 240	15 - 30	  
Savoury pies (vegetable pie, quiche)		Yes	180 - 190	45 - 55	
		Yes	180 - 190	45 - 60	 
		Yes	180 - 190	45 - 70 *	  

FUNCTIONS								ECO	
	Conventional	Forced Air	Convection Bake	Grill	Turbo Grill	MaxiCooking	Cook 4	Eco Cycle	Pizza
ACCESSORIES									
	Wire shelf	Oven tray or cake tray on wire shelf		Drip tray / Baking tray or oven tray on wire shelf		Drip tray / Baking tray		Drip tray with 500 ml of water	



RECIPE	FUNCTION	PREHEAT	TEMPERATURE (°C)	DURATION (MIN.)	SHELF AND ACCESSORIES
Vols-au-vent / Puff pastry crackers		Yes	190 - 200	20 - 30	
		Yes	180 - 190	20 - 40	
		Yes	180 - 190	20 - 40 *	
Lasagna / Flans / Baked pasta / Cannelloni		Yes	190 - 200	45 - 65	
Lamb / Veal / Beef / Pork 1 kg		Yes	190 - 200	80 - 110	
Roast pork with crackling 2 kg	XL	-	170	110 - 150	
Chicken / Rabbit / Duck 1 kg		Yes	200 - 230	50 - 100	
Turkey / Goose 3 kg		Yes	190 - 200	80 - 130	
Baked fish / en papillote (fillets, whole)		Yes	180 - 200	40 - 60	
Stuffed vegetables (tomatoes, courgettes, aubergines)		Yes	180 - 200	50 - 60	
Toast		-	3 (High)	3 - 6	
Fish fillets / Steaks		-	2 (Mid)	20 - 30 **	
Sausages / Kebabs / Spare ribs / Hamburgers		-	2 - 3 (Mid - High)	15 - 30 **	
Roast chicken 1-1.3 kg		-	2 (Mid)	55 - 70 ***	
Leg of lamb / Shanks		-	2 (Mid)	60 - 90 ***	
Roast potatoes		-	2 (Mid)	35 - 55 ***	
Vegetable gratin		-	3 (High)	10 - 25	
Cookies	COOK Cookies	Yes	135	50 - 70	
Tarts	COOK Tarts	Yes	170	50 - 70	
Round pizzas	COOK Pizza	Yes	210	40 - 60	
Complete meal: Fruit tart (level 5) / lasagna (level 3) / meat (level 1)		Yes	190	40 - 120 *	
Complete meal: Fruit tart (level 5) / roasted vegetables (level 4) / lasagna (level 2) / cuts of meat (level 1)	COOK Menu	Yes	190	40 - 120 *	
Lasagna & Meat		Yes	200	50 - 100 *	
Meat & Potatoes		Yes	200	45 - 100 *	
Fish & Vegetables		Yes	180	30 - 50 *	
Stuffed roasting joints	ECO	-	200	80 - 120 *	
Cuts of meat (rabbit, chicken, lamb)	ECO	-	200	50 - 100 *	

\* Estimated length of time: dishes can be removed from the oven at different times depending on personal preference.

\*\* Turn food halfway through cooking.

\*\*\* Turn food two thirds of the way through cooking (if necessary).

FUNCTIONS						XL	COOK	ECO	
	Conventional	Forced Air	Convection Bake	Grill	Turbo Grill	MaxiCooking	Cook 4	Eco Cycle	Pizza
ACCESSORIES									
	Wire shelf	Oven tray or cake tray on wire shelf		Drip tray / Baking tray or oven tray on wire shelf		Drip tray / Baking tray		Drip tray with 500 ml of water	

## HOW TO READ THE COOKING TABLE

The table lists the best function, accessories and level to use to cook different types of food.

Cooking times start from the moment food is placed in the oven, excluding preheating (where required).

Cooking temperatures and times are approximate and depend on the amount of food and the type of accessory used. Use the lowest recommended settings to begin with and, if the food is not cooked enough, then switch to higher settings.

Use the accessories supplied and preferably darkcoloured metal cake tins and baking trays. You can also use Pyrex or stoneware pans and accessories, but bear in mind that cooking times will be slightly longer.

## MAINTENANCE AND CLEANING

**Make sure that the oven has cooled down before carrying out any maintenance or cleaning.**

**Do not use steam cleaners.**

**Do not use wire wool, abrasive scourers or abrasive/corrosive cleaning agents, as these could damage the surfaces of the appliance.**

**Wear protective gloves.**

**The oven must be disconnected from the mains before carrying out any kind of maintenance work.**

### EXTERIOR SURFACES

- Clean the surfaces with a damp microfibre cloth. If they are very dirty, add a few drops of pH-neutral detergent. Finish off with a dry cloth.

- Do not use corrosive or abrasive detergents. If any of these products inadvertently comes into contact with the surfaces of the appliance, clean immediately with a damp microfibre cloth.

### INTERIOR SURFACES

- After every use, leave the oven to cool and then clean it, preferably while it is still warm, to remove any deposits or stains caused by food residues. To dry any condensation that has formed as a result of cooking foods with a high water content, leave the oven to cool completely and then wipe it with a cloth or sponge.

- Activate the "Smart Clean" function for optimum cleaning of the internal surfaces. (Only in some models).

- Clean the glass in the door with a suitable liquid detergent.

- The oven door can be removed to facilitate cleaning.

### ACCESSORIES

Soak the accessories in a washing-up liquid solution after use, handling them with oven gloves if they are still hot. Food residues can be removed using a washing-up brush or a sponge.

Do not clean Food Probe and Meat Probe (if present) in the dishwasher.

Air Fry tray (if present) can be cleaned in the dishwasher.

### WATER DRAWER MAINTENANCE

**Caution:** The water drawer is not suitable for dishwasher use: risk of damage!

At the end of each cooking cycle with steam, after about 30 min the oven automatically performs a drain cycle lasting about one minute, thus transferring all the water in the system to the extractable drawer.

Note: Avoid to leave the water in the system more than 2 days.

In order to completely remove the water inside or clean the internal surfaces, you can open the water drawer:

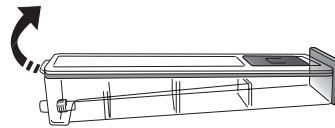

1. Push towards the top the back flap to remove the water drawer top cover.

2. Once the cleaning is done, you can close the drawer by inserting the two front flaps inside the front openings and pushing down the back side.

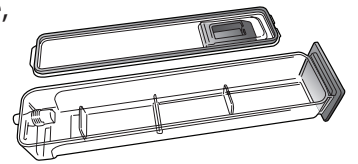

Use only room temperature water when filling the water drawer: hot water may affect the operation of the steam system. Use only drinking water.

### BOILER

To ensure that the oven always works at optimum performance and to help prevent the build-up of limescale deposits over time, we recommend using the "Descale" function regularly. After a long period of non-use of the "Steam" functions, it is highly suggested to activate a cooking cycle with the empty oven by filling completely the tank.

## REMOVING AND REFITTING THE DOOR

**1.** To remove the door, open it fully and lower the catches until they are in the unlock position.

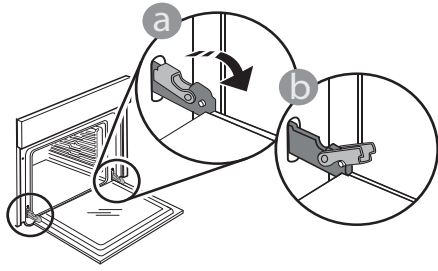

**2.** Close the door as much as you can. Take a firm hold of the door with both hands – do not hold it by the handle.

Simply remove the door by continuing to close it while pulling it upwards at the same time until it is released from its seating. Put the door to one side, resting it on a soft surface.

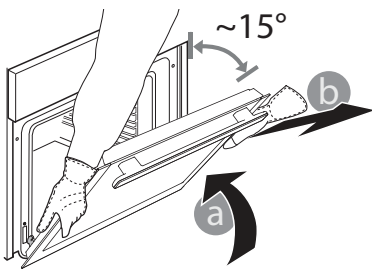

**3.** Refit the door by moving it towards the oven, aligning the hooks of the hinges with their seating and securing the upper part onto its seating.

**4.** Lower the door and then open it fully. Lower the catches into their original position: Make sure that you lower them down completely.

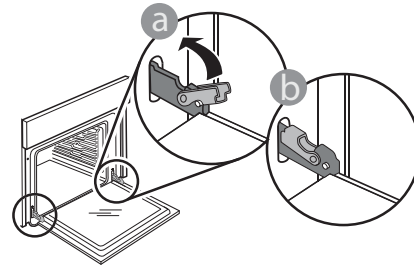

Apply gentle pressure to check that the catches are in the correct position.

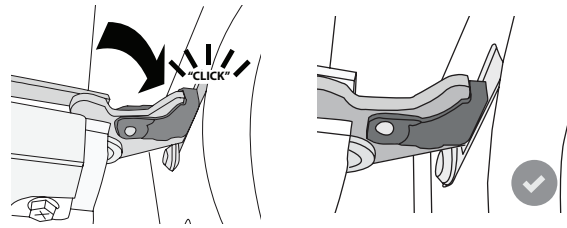

**5.** Try closing the door and check to make sure that it lines up with the control panel. If it does not, repeat the steps above: The door could become damaged if it does not work properly.

## REPLACING THE LAMP

For the replacement of the lamp, contact the after sales service.

# TROUBLESHOOTING

Problem	Possible cause	Solution
The oven is not working.	Power cut. Disconnection from the mains.	Check for the presence of mains electrical power and whether the oven is connected to the electricity supply. Turn off the oven and restart it to see if the fault persists.
The display shows the letter "F" followed by a number.	Software problem.	Contact you nearest Field test reference person and state the number following the letter "F".
A 6th Sense cooking function ends without displaying a countdown. Cooking ends before the end of the countdown.	Amount of food different from the recommended range. Door open during cooking.	Open the door and check the doneness of food. If necessary, complete cooking by selecting a traditional function.
The oven does not heat up.	When "DEMO" is "On" all commands are active and menus available but the oven doesn't heat up. DEMO appears on display every 60 seconds.	Access "DEMO" from "SETTINGS" and select "Off".
The light switches off.	"ECO" mode is "On".	Access "ECO" from "SETTINGS" and select "Off".
The door will not close properly.	The safety catches are in the wrong position.	Make sure that the safety catches are in the correct position by following the instructions for removing and refitting the door in the "Cleaning and Maintenance" section.
The home power goes off.	Power setting wrong.	Verify if your domestic network has at least a rating of more than 3 kW. If no, decrease the power to 13 Ampere. Access "POWER" from "SETTINGS" and select "LOW".
Cooking cycle with probe ended without evident cause or error F3E3 is printed on the screen	Food Probe is not properly connected	Check connection of the food probe

**Policies, standard documentation and additional product information can be found by:**

- Using the QR on your product
- Visiting our website [docs.whirlpool.eu](https://docs.whirlpool.eu)
- Alternatively, **contact our After-sales Service** (See phone number in the warranty booklet). When contacting our After-sales Service, please state the codes provided on your product's identification plate.

