

## SAFETY INSTRUCTIONS

Download the complete instruction manual on <http://docs.whirlpool.eu> or call the phone number shown on the warranty booklet.

Before using the appliance, read these safety instructions. Keep them nearby for future reference. These instructions and the appliance itself provide important safety warnings, to be observed at all times. The manufacturer declines any liability for failure to observe these safety instructions, for inappropriate use of the appliance or incorrect setting of controls.

⚠ **WARNING:** If the hob surface is cracked, do not use the appliance - risk of electric shock.

⚠ **WARNING:** Danger of fire: Do not store items on the cooking surfaces.

⚠ **CAUTION:** The cooking process has to be supervised. A short cooking process has to be supervised continuously.

⚠ **WARNING:** Unattended cooking on a hob with fat or oil can be dangerous - risk of fire. NEVER try to extinguish a fire with water: instead, switch off the appliance and then cover flame e.g. with a lid or a fire blanket.

⚠ Do not use the hob as a work surface or support. Keep clothes or other flammable materials away from the appliance, until all the components have cooled down completely - risk of fire.

⚠ Very young children (0-3 years) should be kept away from the appliance. Young children (3-8 years) should be kept away from the appliance unless continuously supervised. Children from 8 years old and above and persons with reduced physical, sensory or mental capabilities or lack of experience and knowledge can use this appliance only if they are supervised or have been given instructions on safe use and understand the hazards involved. Children must not play with the appliance. Cleaning and user maintenance must not be carried out by children without supervision.

⚠ **WARNING:** The appliance and its accessible parts become hot during use. Care should be taken to avoid touching heating elements. Children less than 8 years of age shall be kept away unless continuously supervised.

### PERMITTED USE

⚠ **CAUTION:** the appliance is not intended to be operated by means of an external switching device, such as a timer, or separate remote controlled system.

⚠ This appliance is intended to be used in household and similar applications such as: staff kitchen areas in shops, offices and other working environments; farm houses; by clients in hotels, motels, bed & breakfast and other residential environments.

⚠ No other use is permitted (e.g. heating rooms).

## IMPORTANT TO BE READ AND OBSERVED

⚠ This appliance is not for professional use. Do not use the appliance outdoors.

### INSTALLATION

⚠ The appliance must be handled and installed by two or more persons - risk of injury. Use protective gloves to unpack and install - risk of cuts.

⚠ Installation, including water supply (if any), electrical connections and repairs must be carried out by a qualified technician. Do not repair or replace any part of the appliance unless specifically stated in the user manual. Keep children away from the installation site. After unpacking the appliance, make sure that it has not been damaged during transport. In the event of problems, contact the dealer or your nearest After-sales Service. Once installed, packaging waste (plastic, styrofoam parts etc.) must be stored out of reach of children - risk of suffocation. The appliance must be disconnected from the power supply before any installation operation - risk of electric shock. During installation, make sure the appliance does not damage the power cable - risk of fire or electric shock. Only activate the appliance when the installation has been completed.

⚠ Carry out all cabinet cutting operations before fitting the appliance and remove all wood chips and sawdust.

⚠ If the appliance is not installed above an oven, a separator panel (not included) must be installed in the compartment under the appliance.

### ELECTRICAL WARNINGS

⚠ It must be possible to disconnect the appliance from the power supply by unplugging it if plug is accessible, or by a multi-pole switch installed upstream of the socket in accordance with the wiring rules and the appliance must be earthed in conformity with national electrical safety standards.

⚠ Do not use extension leads, multiple sockets or adapters. The electrical components must not be accessible to the user after installation. Do not use the appliance when you are wet or barefoot. Do not operate this appliance if it has a damaged power cable or plug, if it is not working properly, or if it has been damaged or dropped.

⚠ Installation using a power cable plug is not allowed unless the product is already equipped with the one provided by the Manufacturer.

⚠ If the supply cord is damaged, it must be replaced with an identical one by the manufacturer, its service agent or similarly qualified persons in order to avoid a hazard - risk of electric shock.

### CLEANING AND MAINTENANCE

⚠ **WARNING:** Ensure that the appliance is switched off and disconnected from the power supply before performing any maintenance operation; never use steam cleaning equipment - risk of electric shock.

---

 Do not use abrasive or corrosive products, chlorine-based cleaners or pan scourers.

### **DISPOSAL OF PACKAGING MATERIALS**

The packaging material is 100% recyclable and is marked with the recycle symbol .

The various parts of the packaging must therefore be disposed of responsibly and in full compliance with local authority regulations governing waste disposal.

### **DISPOSAL OF HOUSEHOLD APPLIANCES**

This appliance is manufactured with recyclable or reusable materials. Dispose of it in accordance with local waste disposal regulations. For further information on the treatment, recovery and recycling of household electrical appliances, contact your local authority, the collection service for household waste or the store where you purchased the appliance. This appliance is marked in compliance with European Directive 2012/19/EU, Waste Electrical and Electronic Equipment (WEEE) and with the Waste Electrical and Electronic Equipment regulations 2013 (as amended).

By ensuring this product is disposed of correctly, you will help prevent negative consequences for the environment and human health.

The symbol  on the product or on the accompanying documentation indicates that it should not be treated as domestic waste but must be taken to an appropriate collection center for the recycling of electrical and electronic equipment.

### **ENERGY SAVING TIPS**

Make the most of your hot plate's residual heat by switching it off a few minutes before you finish cooking.

The base of your pot or pan should cover the hot plate completely; a container that is smaller than the hot plate will cause energy to be wasted. Cover your pots and pans with tight-fitting lids while cooking and use as little water as possible. Cooking with the lid off will greatly increase energy consumption.

**Use only flat-bottomed pots and pans.**

### **DECLARATION OF CONFORMITY**

This appliance meets Ecodesign requirements of European Regulation 66/2014 and The Ecodesign for Energy-Related Products and Energy Information (Amendment) (EU Exit) Regulations 2019 in compliance with the European standard EN 60350-2.



## INSTALLATION

- The cooktop must be set into a worktop at least 20 mm deep.
- There must be nothing between the cooktop and the oven (cross rails, brackets, etc.).
- Make sure the power cord is long enough to allow convenient installation.
- The distance between the lower face of the glass ceramic hob and the cupboard or separating panel must be at least 20 mm.
- For built-in dimensions and installation see the picture in this paragraph.
- A minimum distance must be maintained between the hob and the hood above it. Please refer to the user manual of the hood for more informations.
- Apply the supplied gasket to the cooktop (unless it has already been fitted), after having cleaned its surface.
- **Do not install the cooktop near a dishwasher or washing machine, so that the electronic circuits do not come into contact with steam or moisture, which could damage them.**
- If an oven is installed beneath the cooktop, make sure that it is equipped with a cooling system. If the temperature of the electronic circuits exceeds the maximum permitted temperature, the cooktop will switch off automatically; in this case, wait for a few minutes until the internal temperature of the electronic circuits reaches a tolerable level, at which point it will be possible to switch the hob on again.
- **ATTENTION: to install the hob on other surfaces than wood (marble, plastic, ceramic, marble, stone, etc.) remember to ask After Sales Service for the fixing plates (fig. 2) Code 4819 404 78697.**

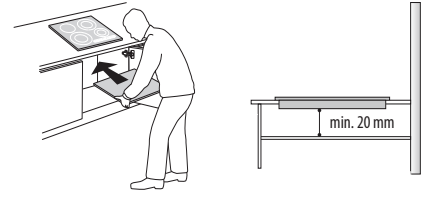

### PLACING THE HOB

**Important: remove any protective film before installing the hob.**

Make sure that the opening in the worktop for the hob is cut according to the dimensions given in the drawing, paying attention to the tolerance range. The hob should not be forced into the worktop. Forcing the glass-ceramic top may cause it to crack (even at a later date)!

**If the worktop is made of wood,** use the spring clips and screws provided. Secure the spring clips (A) (fig. 1) with the screws provided (B) (fig. 1) as shown, paying attention to the specified distances. Fit the hob into the worktop.

**If the worktop is made of marble, plastic, ceramic, stone, etc.,** the hob must be secured with special brackets (C) (fig. 2). Fit the hob into the worktop (fig. 1). Place the 4 brackets (C) in position in accordance with the thickness of the worktop as shown in fig. 2. Fasten the 4 screws (D) in the positions (E) (fig. 2).

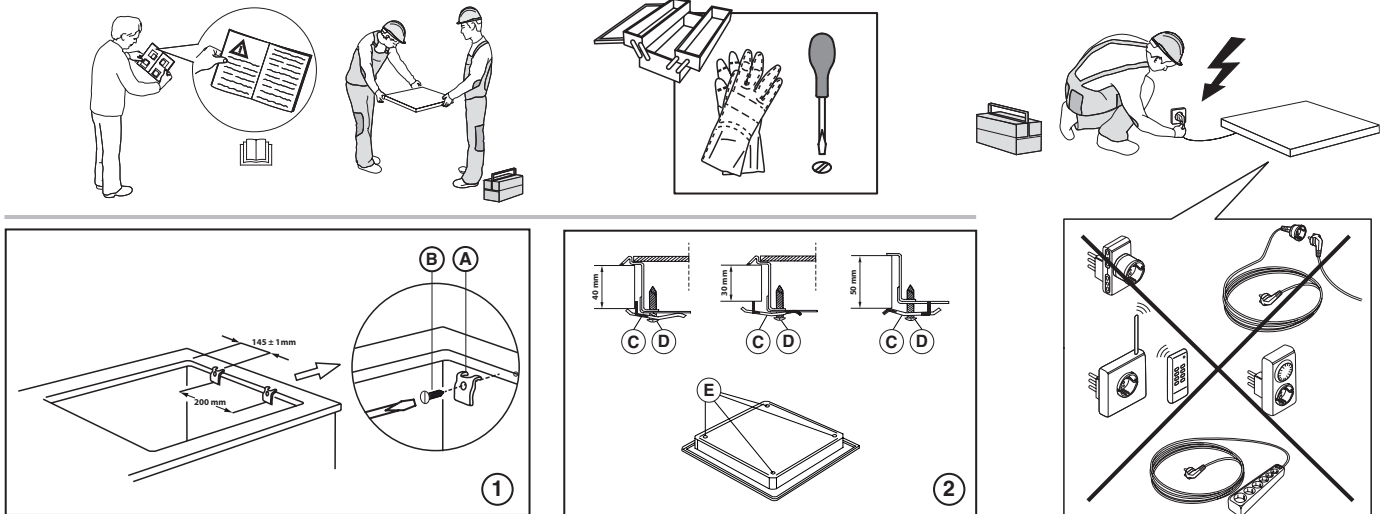

### DIMENSIONS AND DISTANCES TO BE MAINTAINED

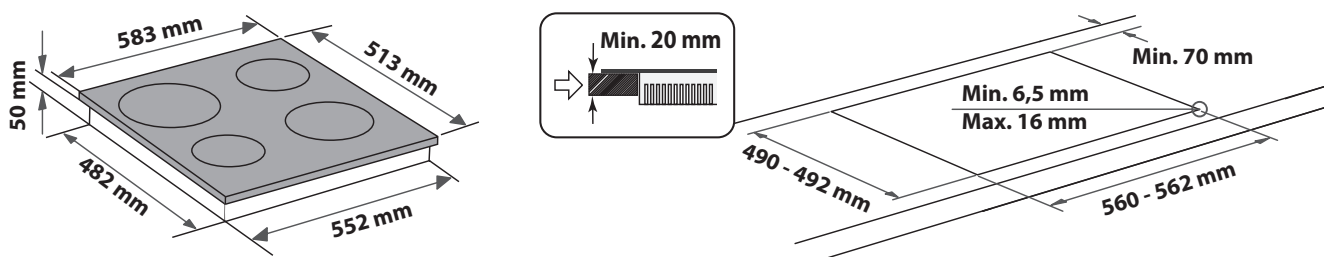
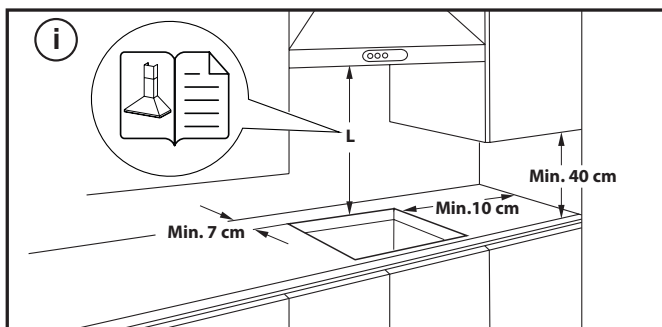

## REMOVING THE HOB:

To remove the hob, first, disconnect it from the electric supply. It is strongly recommended to free the underneath part from the oven, drawer, separator, or other. It allows the technician to access the lower part of the hob to unfasten the four clips with a screwdriver, lift the hob and remove it, avoiding any worktop damage.

## ELECTRICAL CONNECTION

Electrical connection must be made before connecting the appliance to the electricity supply.

The power cord is not included in the package - remember to prepare your own power cord.





Installation must be carried out by qualified personnel who know the current safety and installation regulations. Specifically, installation must be carried out in compliance with the regulations of the local electricity supply company.

Make sure the voltage specified on the data plate located on the bottom of the appliance is the same as that of the home.

Regulations require that the appliance be earthed: use conductors (including the earth conductor) of the appropriate size only.

### CONNECTION TO THE TERMINAL BLOCK

For the electrical connection, use an H05RR-F or H05V2V2-F cable as specified in the table below.

SUPPLY VOLTAGE	CONDUCTORS AMOUNT x SIZE
220-240V ~ + 	3 x 4 mm <sup>2</sup>
220-240V 3~ + 	4 x 1,5 mm <sup>2</sup>
380-415V 3N~ + 	5 x 1,5 mm <sup>2</sup>
380-425V 2N~ + 	4 x 1,5 mm <sup>2</sup>

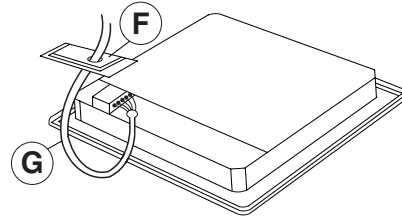

The appliance must be connected to the electricity supply by means of an all-pole disconnect switch with minimum contact gap of 3 mm.

**ATTENTION:** the power supply cable must be long enough to allow the cooktop to be removed from the worktop and must be positioned so as to avoid damage or overheating caused by contact with the base.

**NOTE:** the yellow/green earth wire must be connected to the terminal with the symbol  and must be longer than the other wires.

- Remove approx. 70 mm of the cable sheath from the power supply cable (G).
- Strip approx. 10 mm of sheath from the wires. Insert the cable (G) through the opening in the lid (F).
- Insert the cable into the cable clamp and connect the wires to the terminal block as indicated in the diagram printed on the lid.
- Secure the power supply cable (G) by means of the cable clamp.
- Refit the protection lid (F).
- After the electrical connection, fit the hob from the top and hook it to the support springs, according to the illustration.

## PRODUCT DESCRIPTION

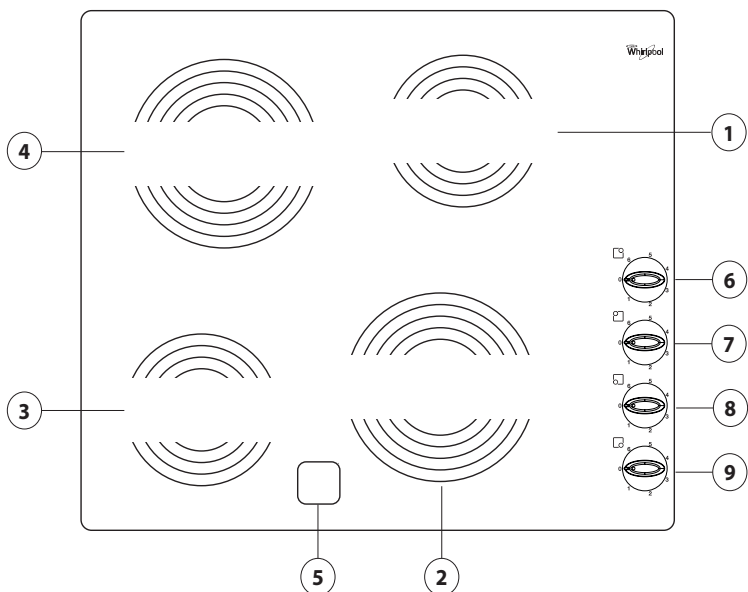

1. Radiant cooking zone Ø 145
2. Radiant cooking zone Ø 180
3. Radiant cooking zone Ø 145
4. Radiant cooking zone Ø 180
5. Residual heat indicator
6. Rear right cooking zone control knob
7. Rear left cooking zone control knob
8. Front left cooking zone control knob
9. Front right cooking zone control knob



## FIRST TIME USE

Before use, remove:

- adhesives stuck on the hob;
- cardboard guards and protective plastic film;

- check whether the hob has been damaged during transport. If in doubt, contact the After Sales Service.

## DAILY USE

### SWITCHING THE HOB ON/OFF

To use the hob, turn the knob(s) clockwise and set it/them to the required power.

To turn the hob off, turn the knob(s) back to position "0".

### RESIDUAL HEAT INDICATOR

The hob is fitted with residual heat indicators. These light up when the cooking zones reach temperatures that could cause burns. These indicators remain alight after the cooking zones are switched off, and turn off only when the zones are no longer hot enough to be dangerous.

**IMPORTANT:** To avoid a permanent damage the hob:

- do not use pots with bottoms that are not flat;
- do not use metal pots with enamelled bottom;
- do not place hot pots/pans over the control panel.

### ACCESSORY

Child guard AMH 122. This accessory can be obtained from the After Sales Service under code number 4819 310 18436 or from your dealer under reference number 017124.

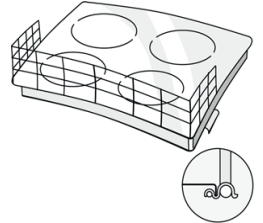

## POWER LEVEL TABLE

POWER LEVEL		TYPE OF COOKING	LEVEL USE (indicating cooking experience and habits)
Maximum power	6	Boiling	Ideal to boil water.
	4 – 5	Grilling – Boil maintenance	Ideal to keep the water boiling and to grill meat, fish and poultry.
High power		Frying	Ideal for sauteing and pan frying.
	Medium power	Gentle frying	Eggs (fried or scrambled), omelette.
3		Simmering – braising – stewing	Ideal for long cooking liquid recipes (sauces, broths, mulled wine) and stewing (goulash and similar).
Low power	2 – 3	Defrosting*	Ideal for thawing delicate food, sauces and creams).
	1	Melting*	Ideal for softening butter, gently melting chocolate, and keeping just-cooked food warm.
Zero	0	–	Hob in stand-by or off mode (possible end of cooking residual heat, indicated by an "H").

\* Supervise the cooking, and once melted, do not leave the food on the cooktop.

## MAINTENANCE AND CLEANING

**⚠ Disconnect the appliance from the power supply.**

- Do not use steam cleaning equipment.
- Do not use abrasive sponges or scouring pads as they may damage the glass.
- After each use, clean the hob (when it is cool) to remove any deposits and stains from food residue.

- Sugar or foods with a high sugar content can damage the hob and must be immediately removed.
- Salt, sugar and sand could scratch the glass surface.
- Use a soft cloth, absorbent kitchen paper or a specific hob cleaner (follow the Manufacturer's instructions).
- Spills of liquid in the cooking zones can cause the pots to move or vibrate.
- After cleaning the hob, dry thoroughly.

## TROUBLESHOOTING

If the hob will not operate correctly, before calling the After-Sales Service, refer to the Troubleshooting Guide to determine the problem.

- Read and follow the instructions given in the section "Daily use".
- Check that the electricity supply has not been shut off.
- Turn the hob off and on again, to make sure that the problem has been solved.

- Make sure that the knob is not turned to "0". Turn the multi-pole switch to "Off" for a few minutes and then turn it back to "On".
- The hob will not switch off: disconnect the hob immediately from the power supply.

If after the above checks the fault still occurs, get in touch with the nearest After Sales Service.

---

## AFTER-SALES SERVICE

---

In order to receive a more complete assistance, please register your product on [www.whirlpool.eu/register](http://www.whirlpool.eu/register).

### BEFORE CALLING THE AFTER-SALES SERVICE:

1. See if you can solve the problem by yourself with the help of the suggestions given in the **TROUBLESHOOTING**.
2. Switch the appliance off and back on again to see if the fault persists.

---

### IF AFTER THE ABOVE CHECKS THE FAULT STILL OCCURS, GET IN TOUCH WITH THE NEAREST AFTER-SALES SERVICE.

To receive assistance, call the number shown on the warranty booklet or follow the instructions on the website [www.whirlpool.eu](http://www.whirlpool.eu).

When contacting our Client After sales service, always specify:

- a brief description of the fault;
- the type and exact model of the appliance;

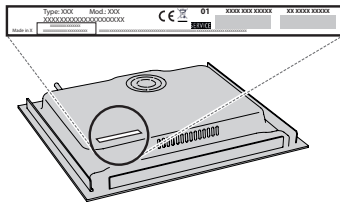

- the serial number (number after the word SN on the rating plate located under the appliance). The serial number is also indicated in the documentation;



Mod. **XXX XXX**

Ind.C. **XXXX XXXX XXXX**

Prod.N. **86999XXXXXXX** S.N. **XXXX XXXX XXXX**

- your full address;
- your telephone number.

If any repairs are required, please contact an authorized after-sales service (to guarantee that original spare parts will be used and repairs carried out correctly).