



THANK YOU FOR BUYING A WHIRLPOOL PRODUCT
 In order to receive a more complete assistance, please register your product on www.whirlpool.eu/register



Before using the appliance carefully read the Safety Instruction.

PRODUCT DESCRIPTION

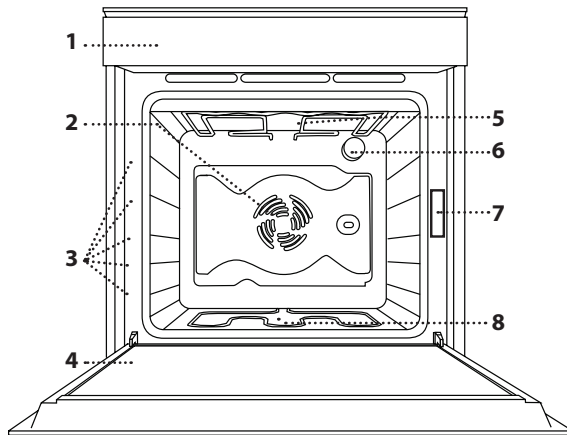

- 1. Control panel
- 2. Fan
- 3. Shelf guides (the level is indicated on the front of the oven)
- 4. Door
- 5. Upper heating element/grill
- 6. Lamp
- 7. Identification plate (do not remove)
- 8. Bottom heating element (non-visible)

CONTROL PANEL

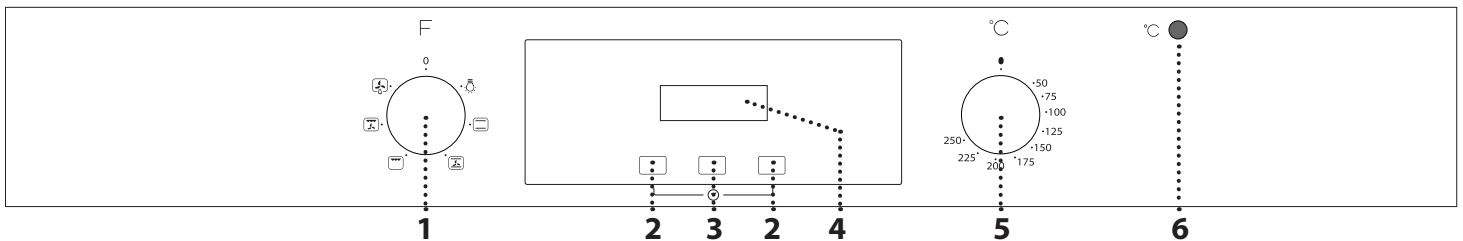

1. SELECTION KNOB

For switching the oven on by selecting a function. Turn to the position 0 to switch the oven off.

2. - / + BUTTONS

To decrease or increase the value shown on the display.

3. TIME BUTTON

For selecting the various settings: duration, cooking end time, timer.

4. DISPLAY

5. THERMOSTAT KNOB

Turn to select a desired temperature, activating the selected function.

6. LED THERMOSTAT / PREHEATING

Switches on during the heating process. Switches off once the desired temperature is reached.

ACCESSORIES

The number and type of accessories may vary depending on which model is purchased. Other accessories that are not supplied can be purchased separately from the After-sales Service.

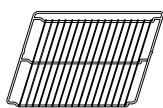

WIRE SHELF. Use to cook food or as a support for pans, cake tins and other ovenproof items of cookware.



DRIP TRAY. Use as an oven tray for cooking meat, fish, vegetables, focaccia, etc. or position underneath the wire shelf to collect cooking juices.

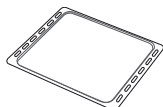

BAKING TRAY. Use for cooking all bread and pastry products, but also for roasts, fish en papillote, etc.

Insert the wire shelf horizontally by sliding it across the shelf guides, making sure that the side with the raised edge is facing upwards.

Other accessories, such as the drip tray and the baking tray, are inserted horizontally in the same way as the wire shelf.

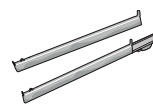

SLIDING RUNNERS.*

To facilitate inserting or removing accessories. Remove the protective plastic off them. Place the drip tray on the telescopic runners fixing it between the rear and front fastener.

The sliding runners can be fitted on any level. To fit the sliding runners, fasten the upper clip of the runner to the shelf guide and slide it along as far as it will go (1). Lower other clip into position. To secure the guide, press the lower portion of the clip firmly against the shelf guide (2). Make sure that the runners can move freely. Repeat these steps on the other shelf guide on the same level.

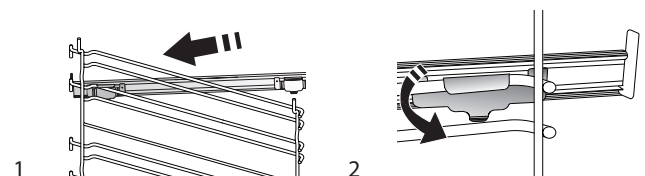

REMOVING AND REFITTING THE SHELF GUIDES

To remove the shelf guides, lift the guides up and then gently pull the lower part out of its seating; the shelf guides can now be removed. To refit the shelf guides, first fit them back into their upper seating. Keeping them held up, slide them into the cooking compartment, then lower them into position in the lower seating.

* Available only on certain models

FIRST TIME USE

1. SETTING THE TIME AND THE TONE

You will need to set the time of the day when you switch on the appliance for the first time: "AUTO" and "0.00" flash on the display.



To set the time of day, press buttons **+** and **-** at the same time: Set the time of day using the **+** and **-** buttons.

Press the *time button* to confirm.

Having selected the desired time value, it is possible to change the alarm tone: the display shows "ton 1".



To select the desired tone, press button **-**, then press the *time button* to confirm.

Please note: To change the time of the day afterwards for example following lengthy power outages, proceed as described above.

FUNCTIONS & DAILY USE

. SELECT A FUNCTION

To select a function, turn the *selection knob* to the symbol for the function you require.



OFF

For switching off the oven.



LAMP

To switch the oven light on.



CONVENTIONAL

For cooking any kind of dish on one shelf only.

Icon	Checkmark	Temp (°C)	Time	Shelf
Leavened cakes	✓	160 - 180	35 - 55	2
Biscuits/tartlets	✓	170 - 180	15 - 40	3
Frozen Pizza	✓	250	10 - 15	2
Lasagne / baked pasta / cannelloni / flans	✓	190 - 200	40 - 65	2
Lamb / veal / beef /pork 1 kg	✓	190 - 200	90 - 110	2
Chicken / rabbit / duck 1 kg	✓	190 - 200	65 - 85	2
Baked fish / en papillote 0,5 kg (fillets, whole)	✓	180 - 200	40 - 60	2



SMART CLEAN (Only in some models)

The action of the steam released during this special low-temperature cleaning cycle allows dirt and food residues to be removed with ease. This function should be activated only when the oven is cold and after having poured 200 ml of drinking water into the bottom of the oven. Set the timer for 30 minutes and the temperature at 90°C. Once the cycle is finished, wait about 15 minutes before opening the door.



CONVECTION BAKE

For cooking meat or baking cakes with liquid centre on a single shelf. This function delivers an even, golden, crisp top and base.

Icon	Checkmark	Temp (°C)	Time	Shelf
Filled cake	✓	180 - 200	50 - 60	2
Salty cakes	✓	180 - 200	35 - 55	2
Stuffed vegetables	✓	175 - 200	40 - 60	2

2. HEAT THE OVEN

A new oven may release odours that have been left behind during manufacturing: this is completely normal. Before starting to cook food, we therefore recommend heating the oven with it empty in order to remove any possible odours.

Remove any protective cardboard or transparent film from the oven and remove any accessories from inside it.

Heat the oven to 250 °C for about one hour. The oven must be empty during this time. Follow the instructions for setting the function correctly.

Please note: It is advisable to air the room after using the appliance for the first time.



GRILL

For grilling steaks, kebabs and sausages, cooking vegetables au gratin or toasting bread. When grilling meat, we recommend using a drip tray to collect the cooking juices: position the tray on any of the levels below the wire shelf and add 500 ml of drinking water.

Icon	Checkmark	Temp (°C)	Time	Shelf
Toasted bread	✓	200	2 - 5	4
Fish fillets / slices	✓	200	30 - 40 *	4 3
Sausages / kebabs / spare ribs / hamburgers	✓	200	30 - 50 *	4 3

* Turn food halfway through cooking



TURBO GRILL

For roasting large joints of meat (legs, roast beef, chicken). We recommend using a drip tray to collect the cooking juices: position the pan on any of the levels below the wire shelf and add 500 ml of drinking water.

Icon	Checkmark	Temp (°C)	Time	Shelf
Roast chicken 1-1,3 kg	—	200	55 - 70 *	2 1
Roast beef rare 1 kg	—	200	30 - 40 **	2
Roast potatoes	—	200	45 - 55 **	2

* Turn food halfway through cooking





** Turn food two thirds of the way through cooking (if necessary).







DEFROST

For defrosting food more quickly. Place food on the middle shelf. Leave food in its packaging in order to prevent it from drying out on the outside.

HOW TO READ THE COOKING TABLES

The table lists recipes , if preheating is needed , temperature , cooking time , accessories and level  suggested for cooking. Cooking times start from the moment food is placed in the oven, excluding preheating (where required). Cooking temperatures and times are approximate and depend on the amount of food and the type of accessory used. Use the lowest recommended settings to begin with and, if the food is not cooked enough, then switch to higher settings. Use the accessories supplied and preferably dark-coloured metal cake tins and baking trays. You can also use Pyrex or stoneware pans and accessories, but bear in mind that cooking times will be slightly longer.

Accessories showed:

-  Wire Shelf
-  Cake tin on wire shelf
-  Drip tray / baking tray
-  Cake tin on wire shelf or drip tray / baking tray
-  Tray with water

. ACTIVATE A FUNCTION

To start the function you have selected, turn the *thermostat knob* to set the temperature you require.

To interrupt the function at any time, switch off the oven, turn the *selection knob* and the *thermostat knob* to  and .

Once the function has been activated, the LED thermostat lights up, switching off again when the oven reaches the selected temperature: At this point, place the food inside and proceed with cooking.

Please note: placing the food in the oven before preheating has finished may have an adverse effect on the final cooking result.

. USING THE ELECTRONIC PROGRAMMER



By pressing the *time button* it is possible to select various mode to keep or program the cooking time.

Please note: After few seconds without any interaction, a buzzer sounds and all settings will be confirmed.

SETTING THE MINUTE MINDER

This option does not interrupt or activate cooking but allows you to use the display as a timer, both while a function is active and when the oven is off.

To activate the timer, long press the *time button*: the  symbol flashes on the display (1).

Use the  and  buttons to set the desired duration: the countdown begins after a few seconds. The display shows the time of the day and the  remains lit, confirming the timer has been set (2).

At the end, long press the *time button* to deactivate the alarm.





Please note: To view the countdown and change it if necessary, press the time button 2 seconds again.

SETTING THE DURATION

After selecting and activating the function, in order to stop it automatically, you can set a cooking time.

Long press the *time button*: the  symbol flashes (3).

Press the *time button* again: DUR and AUTO will flash on the display (4).

Set the duration using the  and  buttons.



After a few seconds, the display will show the time of the day while AUTO remains lit, confirming the setting (5).



Please note: To see how much time is left and change the remaining cooking time repeat the steps above.

When the set cooking time is over, an alarm will sound and the cooking will be stopped (6).



Long press the *time button* to deactivate the alarm. Return the *selection knob* and *thermostat knob* to  and  to switch off the oven.

FULLY AUTOMATIC PROGRAM / DELAYED START

You can delay the start of the function by programming its end time.

After setting the duration, press the *time button* until the display shows END (7).



Press the buttons  and  to select the desired cooking end time.

After a few seconds the display shows the time of the day, while the symbol  switches off and AUTO remains lit, confirming the setting (8).

Please note: To see and change the settings set repeat the steps above.

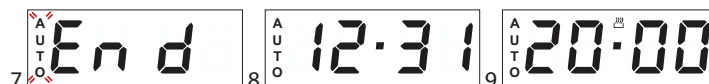
The function will remain paused until the symbol  lights up: at that point the oven proceeds automatically with the selected cooking mode (9).



At the end, long press the *time button* to deactivate the alarm. Return the *selection knob* and *thermostat knob* to  and  to switch off the oven.

Please note: By only selecting the end time (with no duration setting), the function will immediately start. The cooking will continue up to the required end time.

CLEANING AND MAINTENANCE

Make sure that the oven has cooled down before carrying out any maintenance or cleaning.

Do not use steam cleaners.

Do not use wire wool, abrasive scourers or abrasive/corrosive cleaning agents, as these could damage the surfaces of the appliance.

Wear protective gloves.

The oven must be disconnected from the mains before carrying out any kind of maintenance work.

EXTERIOR SURFACES

Clean surfaces with a damp microfibre cloth. If they are very dirty, add a few drops of pH-neutral detergent. Finish off with a dry cloth. Do not use corrosive or abrasive detergents. If any of these products inadvertently comes into contact with the surfaces of the appliance, clean immediately with a damp microfibre cloth.

INTERIOR SURFACES

After every use, leave the oven to cool and then clean it, preferably while it is still warm, to remove any deposits or stains caused by food residues. To dry any condensation that has formed as a result of cooking foods with a high water content, leave the oven to cool completely and then wipe it with a cloth or sponge. Clean the glass in the door with a suitable liquid detergent. The oven door can be removed to facilitate cleaning.

ACCESSORIES

Soak the accessories in a washing-up liquid solution after use, handling them with oven gloves if they are still hot. Food residues can be removed using a washing-up brush or a sponge.

REPLACING THE LAMP

Disconnect the oven from the power supply, unscrew the cover from the light, replace the bulb and screw the cover back on the light. Reconnect the oven to the power supply.

Please note: Only use 20-40 W/230 V type G9, T300 °C halogen bulbs. The bulb used in the product is specifically designed for domestic appliances and is not suitable for general room lighting within the home (EC Regulation 244/2009). Light bulbs are available from our After-sales Service. Do not handle bulbs with your bare hands as your fingerprints could damage them. Do not use the oven until the light cover has been refitted.

REMOVING AND REFITTING THE DOOR

To remove the door, open it fully and lift the catches, pushing them forwards until they are in the unlock position (1). Close the door as much as you can. Take a firm hold of the door with both hands – do not hold it by the handle. Simply remove the door by continuing to close it while pulling it upwards at the same time until it is released from its seating (2). Put the door to one side, resting it on a soft surface.

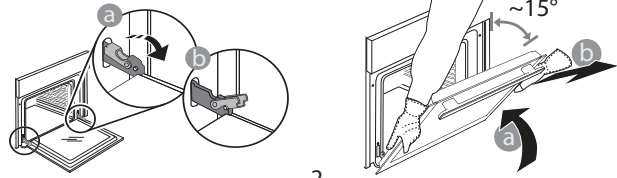

1

2

Refit the door by moving it towards the oven, aligning the hooks of the hinges with their seating and securing the upper part onto its seating. Lower the door and then open it fully. Lower the catches into their original position (3): Make sure that you lower them down completely. Apply gentle pressure to check that the catches are in the correct position.

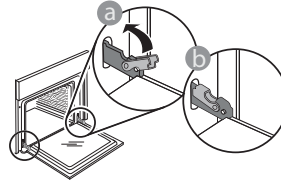

3

Try closing the door and check to make sure that it lines up with the control panel. If it does not, repeat the steps above: The door could become damaged if it does not work properly.

TROUBLESHOOTING

What to do if...	Possible reasons	Solutions
The oven is not working.	Power cut. Disconnection from the mains.	Check for the presence of mains electrical power and whether the oven is connected to the electricity supply. Turn off the oven and restart it to see if the fault persists.



You can download the Safety Instructions, User Manual, Product Fiche and Energy data by:

- Visiting our website docs.whirlpool.eu
- Using QR Code
- Alternatively, **contact our After-sales Service** (See phone number in the warranty booklet). When contacting our After-sales Service, please state the codes provided on your product's identification plate.

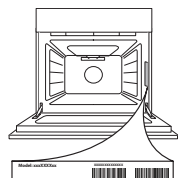

Whirlpool



400011626946