



THANK YOU FOR BUYING A HOTPOINT PRODUCT.
In order to receive a more complete assistance,
please register your product on
www.hotpoint.eu/register



**Before using the appliance carefully
read the Safety Instruction.**



PLEASE SCAN THE QR CODE ON YOUR APPLIANCE IN ORDER TO REACH MORE INFORMATION.

CONTROL PANEL

- 1 ON/OFF Button (hold for Reset)
- 2 Programme Selection Knob
- 3 Start/Pause
- Options Buttons***
- 4 Crease Care
- 5 Dryness Level
- 6 Start Delay
- 7 Timed Drying
- 8 Cycle End
- 9 Gentle (hold for Key Lock)
- 10 Rapid (hold for Mute)

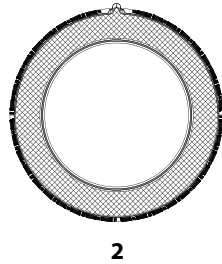

2

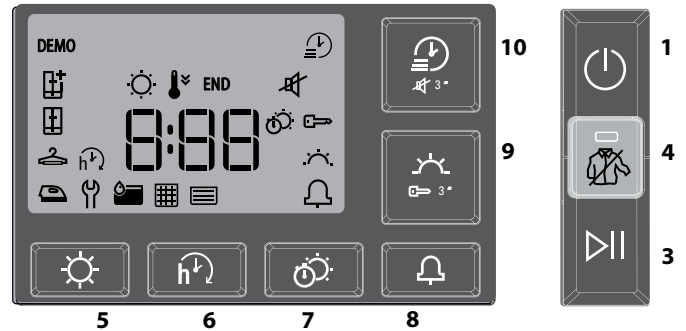

*Note: some models may have the wording in full instead of the icons.

INDICATORS

Dryness Level: ☀ Iron Dry - 🚪 Hanger Dry - 📦 Cupboard Dry - 🏠 Extra Dry

Cycle Phase: ☀ Drying - 🚿 Cool Down - **END** End of Cycle

🚰 Empty water tank - 🧺 Clean door filter - 📄 Clean bottom filter

Refer to troubleshooting section: 🛠 Failure: Call after sales service

FIRST TIME USE

Make sure that the water tank is correctly inserted. Make sure that the drain hose on the back of the dryer is fixed correctly, either to the dryer's water tank, or to your domestic drainage system.

The dryer must be installed in a room with a temperature ranging between 5°C and 35°C to ensure proper operation. Before using the dryer make sure it has been in an upright position for at least 6 hours.

Should you wish to change the opening side of the door, please contact our After-sales Service. (See phone number in the warranty booklet).

DAILY USE

Doing this will keep your machine working at its BEST:

- remember to empty your water tank after each drying cycle.

- remember to clean your filters after each drying cycle.

Refer to the Care & Maintenance section.

1. Plug the dryer into the power supply socket.
2. Open the door and load garments; always refer to instructions on clothing labels and the max loads indicated in the programme section. Empty pockets. Make sure garments do not get caught between the door and/or the door filter. Do not load items that are dripping wet. Do not tumble dry large, very bulky items. For optimal drying result, garments should be loaded one by one.
3. Close the door.
4. Press the "On/Off" button.
5. Select the most suitable programme for the type of fabric in that load.
6. Select the options, if necessary.
7. Press the "Start/Pause" button to begin drying.
8. At the end of the drying cycle, a buzzer will beep. An indicator on the control panel signals the end of the cycle. Turn the machine off by pressing the "On/Off" button, open the door and pull the clothing immediately out to prevent the formation of creases on laundry.

If the machine is not switched off manually, after about a quarter of an hour from the end of the cycle, the appliance turns off automatically to save energy.

Note that some programme/option accords with "Crease Care" system. This means that for some hours, after the end of the drying cycle, the drum rotates at regular intervals to prevent the formation of creases.

Note that some models perform a final cool tumble phase, for this reason the fabrics may not feel hot.

In case of power failure, it is necessary to press the "Start/Pause" button to restart the cycle.

Opening The Door During The Cycle

The tumble dryer door can be opened at any time during the cycle to check progress and remove any garments already dry.

However, since opening the door can extend the drying time, the recommendation is to keep the door closed throughout the cycle process to save time and energy.

After closing the door, press the "Start/Pause" button within 15 minutes to resume the machine operation.

CARE LABEL

Always check the care labels, especially when placing garments in the tumble dryer for the first time. Below are the most commonly used symbols:

- ☐ May be tumble dried.
- ☒ Do not tumble dry.
- ☀ Tumble dry – high heat.
- ☁ Tumble dry – low heat.



PROGRAMS

The duration of these programs will depend on the size of the load, types of textiles, the spin speed used in your washer and any extra options selected. **In machines equipped with display, the duration of the cycles is shown on the control panel.** The remaining time is constantly checked and adjusted during the drying cycle to show the best possible estimate.
Option to use - If all your loads on Automatic Cycles are consistently less dry or more dry than you would like, you may increase or decrease the dryness level using the specific option.

 **Mixed** **kg 4**
This programme is ideal for drying cotton and synthetic fabrics together.

 **Eco** **kg Max***
This is the most efficient programme in terms of energy consumption and is suitable for drying normal wet cotton laundry. The values on the Energy Label are based on this programme.

NOTE: For optimal energy efficiency this cycle by default is set up to "Cupboard Dry" level. For a higher dryness level we suggest using the Cotton cycle.

 **Cotton** **kg Max***
Cycle suitable for drying all types of cotton, ready to be placed in the cupboard.

 **Synthetics** **kg 4**
For drying synthetic fabrics.

 **Wool** **kg 1**
Programme for drying wool clothes. It is advisable to turn the items inside out before drying. If heavy edges remain damp, leave them to dry naturally.

 **Silk** **kg 0.5**
Gentle drying of silk garments.

 **Anti Allergy** **kg Max***
This cycle has the "Allergy UK" approval of "The British Allergy Foundation" attesting the effective reduction and elimination of allergens. It can be used both with damp load (drying and treatment) and dry load (half load only).

 **Cuddly Toys** **kg 2.5**
This cycle preserves the appearance of cuddly toys, keeping them at their best. Remove all accessories before proceeding with drying. Each single piece must not exceed 600 gr.

 **Pre-Iron**
This cycle relaxes fibres, thus making ironing and folding easier. Suitable for small load of damp or dry cotton and cotton blend fabrics. Not for wet items.

 **Refresh**
A short programme suitable for refreshing fibres and garments through the emission of fresh air. Do not use on wet items. It can be used on with any load size but is more effective with small loads. It lasts about 20 minutes.

 **Duvet**
Programme intended to dry bulky items, such as a single duve.

 **Bed & Bath** **kg Max***
This programme is intended for drying cotton towels and sheets.

 **Baby** **kg 2**
A programme intended to dry garments and linen of new-born babies (cotton and chenille), as well as delicate garments. Do not dry garments having plastic covering.

 **Jeans** **kg 3**
For drying sturdy cotton including denim trousers and jackets.

 **Shirts** **kg 3**
This is a programme for cotton or cotton blend/synthetics shirts.

OPTIONS

These buttons allow you to personalise the selected programme according to personal requirements.
Not all options are available for all programmes. Some options may be incompatible with ones you have previously set; if so, you will be alerted by the buzzer and/or blinking indicators. If the option is available, the option indicator will stay on. The programme may retain some options selected in previous drying cycles.

 **Dryness Level**
Press the relevant button several times to obtain a different level of residual moisture on your laundry. An indicator signals the level being selected.

 **Iron Dry:** very delicate drying. Items will be more easily ironed immediately after the cycle.

 **Hanger Dry:** a level intended for delicate garments ready to be hanged.

 **Cupboard Dry:** the laundry is ready to be folded and put away.

 **Extra Dry:** for laundry intended to be worn at the end of the cycle.

 **Start Delay**
This option is for delaying the start of the cycle. Press the corresponding button several times to find the required delay. Once the max time is reached, the option is reset by pressing the button again. An indicator on the control panel signals the time being selected. After pressing the "Start/Pause" button, the machine signals the time remaining to the start of the cycle. If the door is opened, press the "Start/Pause" button once the door has been closed.

 **Timed Drying**
This option is to manually set the drying time. Press the corresponding button to set the required time for drying. An indicator on the control panel signals the time being selected.

 **Cycle End**
This option activates a prolonged buzzer at the end of the cycle. Enable it if you do not think you will hear the normal sound at the end of the cycle. This option remains in memory, if selected in previous drying.

 **Gentle**
Enables a more gentle treatment of the laundry by reducing the drying temperature.

 **Key Lock**
This option makes all machine controls inaccessible, except the "On/Off" button. When the machine is on:
• to activate the option, keep the button pressed until the machine signals that the option has been enabled.
• to disable the option, keep the button pressed until the machine signals that the option has been disabled.
This option remains in memory if selected in previous drying.

 **Crease Care**
This option add a crease treatment at the end of the cycle by means of a periodic rotation of the drum (duration up to 10 hours). It is particularly suitable when it is not possible to remove the laundry as soon as the drying ends. If this option is used together with the Start Delay, the crease treatment is added also in the Start Delay phase. This option remains in memory if selected in the previous drying.

 **Mute**
This option turns off all sounds of control panel. Only warnings remain active. When the machine is on:
• to activate the option, keep the button pressed until the machine signals that the option has been enabled.
• to disable the option, keep the button pressed until the machine signals that the option has been disabled.

 **Rapid**
Enables quicker drying.

***MAX LOAD 9 Kg (Dry load)**

CARE AND MAINTENANCE

WARNING: unplug the dryer during the cleaning and maintenance procedures.

Emptying the water tank after each cycle (see Fig. A).

Pull the container out of the dryer and empty it into a sink or other suitable drain, then place it back properly. Do not use the dryer without having inserted the container back in place.

Cleaning the door filter after each cycle (see Fig. B).

Pull the filter out and clean it by removing the lint from the filter surface under running water or using a vacuum cleaner. For optimal performance, dry up the filter before inserting it back in place.

Do not use the dryer without having reinserted the filter in place.

Remove the door filter as described below:

1. Open the door and pull the filter upwards.
2. Open the filter and remove the lint from all its parts. Replace the filter correctly making sure it is fully seated.

Cleaning the bottom filter when the relevant indicator turns on (see Fig. C).

Pull the filter out and remove the lint from its surface by washing it under running water or by using a vacuum cleaner.

However, it is advisable to clean this filter after each cycle to optimise drying performance.

Do not use the dryer without having reinserted the filter in place.

Remove the bottom filter as described below:

C1. Open the bottom cover; take the handle and pull the filter out.

C2. Open the rear side of the filter and remove the lint from the inner surface of the mesh.

C3 / C4. Check the bottom filter chamber every month. If you see residual lint accumulated on the metal fins, clean it with a vacuum cleaner, using a nozzle with a brush.

It's crucial to do vertical movements, you may destroy the component if you try to clean it in horizontal direction. Avoid the direct contact of the hand with the fins - risk of cut.

C5. Close the rear side of the filter and place it back by checking it is perfectly integrated into its seat, then lower the filter handle.

C6. Close the bottom cover.

Make sure the air intake is free.

The filters are essential parts for drying. They are intended to collect the lint formed during the drying process. In case of clogged filters, the air flow inside the dryer would be seriously affected: the drying times would be longer, the energy consumption would increase and the dryer could be damaged. If these procedures are not carried out properly, the dryer may not start.

NOTE: After cleaning the filters the relevant indicator remains on; this is normal, it will disappear when you start a new drying cycle.



TRANSPORT AND HANDLING

Never lift the dryer by holding it at the worktop.

1. Unplug the dryer.
2. Remove the water from the water tank completely.
3. Make sure that door and water tank are properly closed.
4. If the drain hose is connected to your drainage system, re-connect it to the back of the dryer (see "Installation" section in the Safety Instruction guide).

Cleaning the tumble dryer

- The external metal, plastic and rubber parts can be cleaned with a damp cloth.
- Clean the front air intake grille regularly (every 6 months) with a vacuum cleaner to remove any lint, fluff or dust deposits. Furthermore, remove any lint deposits from the filters area, using a vacuum cleaner every so often.
- Do not use solvents or abrasives.

Power consumption			
off-mode (Po) - Watts			0.42
left-on mode (Pl) - Watts			2.00
Programs	kg	kWh	Minutes
Eco* 	9	2.13	211
Eco 	4.5	1.19	131
Synthetics	4	0.73	95
*This is the reference programme for the energy label and suitable to dry normal wet cotton laundry. This is the most efficient programme in terms of energy consumption for drying wet cotton laundry. (Standard/Default starting configuration)			

Heat Pump System

The heat pump contains fluorinated greenhouse gases, contained in a hermetically sealed unit. This sealed unit contains 0.18 kg of the R134a gas. GWP = 604 (1 t CO₂).

PRODUCT DESCRIPTION

1. Water Tank
2. Air Intake
3. Bottom filter
4. Door filter

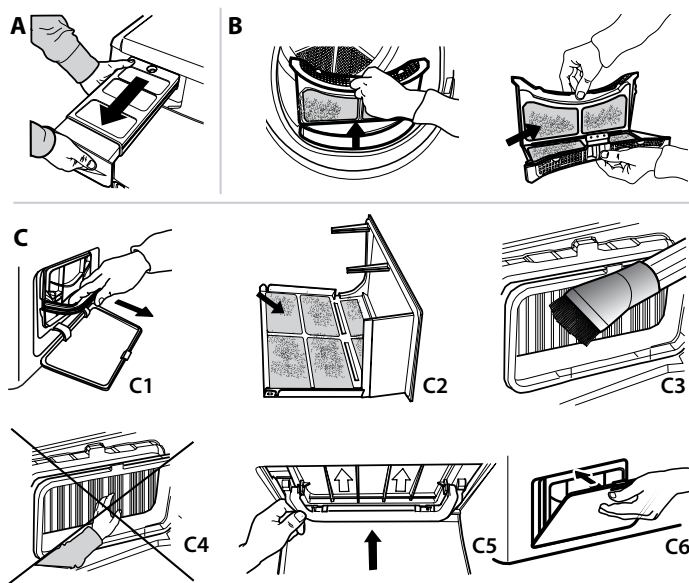
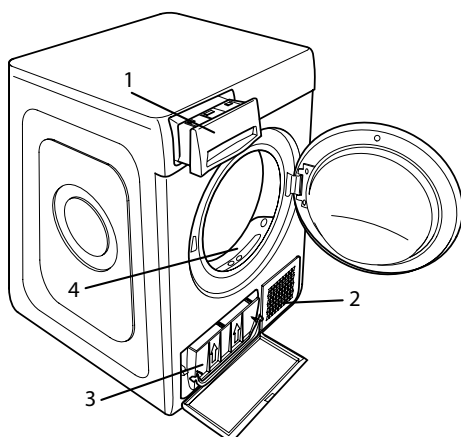

Before contacting the After-sales Service, refer to the table below. Often the malfunctions are minor and can be solved in few minutes.

Malfunction	Possible cause	Solution
The drying times are very long.	An appropriate maintenance was not carried out.	Refer to the Cleaning & Maintenance section and perform the operations described.
	The garments are too wet.	Carry out a washing cycle with higher spin speed to remove as much water as possible.
	Room temperature.	The drying time may be longer if the room temperature falls outside the 14–30°C range.
	The programme, the time and/or the drying level set are not suitable for the type and the amount of load inserted into the dryer.	Refer to Programmes and Options sections to find the programme and options most suitable for the type of load.
	The dryer may be overloaded.	Refer to the Programmes section to check the max load for each programme.
The tumble dryer does not turn on.	The "On/Off" button was not pressed.	Press the "On/Off" button.
	The plug is not inserted into the socket.	Insert the plug into the socket.
	The socket is faulty.	Try to plug another appliance in the same socket. Do not use connecting electrical devices to the socket, such as adapters or extensions.
	A power failure occurred.	Wait for the power supply to be restored and switch the fuse on again if necessary.
The tumble dryer does not start.	The door has not been closed properly.	Close the door.
	A time delay was set to the start of the cycle.	For machines equipped with this function: wait for the set delay to end or switch the machine off to reset it. Refer to the Options section.
	The "Start/Pause" button was not pressed.	Press the "Start/Pause" button.
	The Key Lock function was enabled (for machines equipped with this option).	If Key Lock was selected, disable it. Switching the machine off will not disable this option. Refer to the Options section.
Garments are wet at cycle completion.	Small load.	The automatic programme has not sensed the required final moisture so that the dryer completes the programme and stops. If this happens simply select an additional short period of drying or select Extra Dry option if available.
	Large loads or heavier fabrics.	Dryness levels can be modified to the specific dryness desired. Extra Dry is recommended for ready to wear items.
	The drying cycle was paused and then not reactivated within 15 minutes, causing the machine to shut down.	The drying cycle has to be set up once more and restarted.
	A power failure might have occurred, causing the machine to shut down.	The drying cycle has to be set up once more and restarted.
Lights on or flashing		
Water tank	The water tank is full.	Empty the water tank. Refer to the Cleaning & Maintenance section.
Door filter	Failure of the air flow necessary for machine operation.	Clean the door filter and check whether air intake is free. Carrying out these operations improperly may cause damages. Refer to Cleaning & Maintenance section.
Bottom filter*	The bottom filter requires cleaning.	Clean the bottom filter. Refer to Cleaning & Maintenance section.
The presence of wrench symbol signals a malfunction.	The machine sensors detected a failure.	Switch the dryer off and unplug it. Open the door immediately and pull laundry out, to allow the heat to dissipate. Wait for about 15 minutes. Reconnect the dryer to the power supply, load the laundry and restart the drying cycle. If the problem still occurs, contact the After-Sales Service Centre and communicate the letters and digits flashing on the display. For instance: F3 and E2.

*Note: some models are auto-cleaning and not equipped with bottom filter. Please refer to the Cleaning & Maintenance section.

Policies, standard documentation, ordering of spare parts and additional product information can be found by:

- Using QR code in your appliance
- Visiting our website docs.hotpoint.eu and parts-selfservice.whirlpool.com
- Alternatively, **contact our After-sales Service** (See phone number in the warranty booklet). When contacting our After-sales Service, please state the codes provided on your product's identification plate.

