

# CONTENTS

## QUICK REFERENCE GUIDE

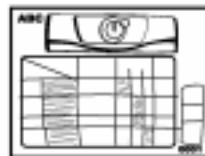

### PROGRAMME CHART

PREPARING THE LAUNDRY

SELECTING A PROGRAMME AND OPTIONS

STARTING AND COMPLETING A PROGRAMME

CHANGING A PROGRAMME

INTERRUPTING A PROGRAMME

DAILY MAINTENANCE AND CLEANING

## INSTRUCTIONS FOR USE

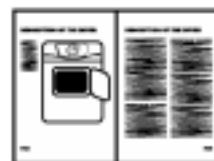

### BOOKLET

BEFORE USING THE DRYER / CONNECTIONS PAGE 11

ELECTRICAL CONNECTION PAGE 12

PRECAUTIONS AND GENERAL  
RECOMMENDATIONS PAGE 13

DESCRIPTION OF THE DRYER PAGE 14

DRAINAGE SYSTEM PAGE 15

DOOR REVERSIBILITY / CHILD SAFETY LOCK PAGE 16

HEAT EXCHANGER PAGE 17

TROUBLESHOOTING GUIDE / AFTER-SALES  
SERVICE PAGE 18

# BEFORE USING THE DRYER / CONNECTIONS

## 1. Removing the packaging and check

- After unpacking, make sure that the dryer is undamaged. If in doubt, do not use the dryer. Contact After-Sales Service or your local retailer.
- Keep the packaging materials (plastic bags, polystyrene parts, etc.) out of reach of children, as they are potentially dangerous.
- Remove the protective foil from the control panel.

## 2. Electrical Connections

- Electrical connections must be carried out by a qualified technician in compliance with the manufacturer's instructions and current standard safety regulations.
- Electrical connection must comply with local Electricity Board regulations.
- Voltage information, power consumption and the required fuse protection is shown on the rating plate mounted at the rear of the dryer.
- The manufacturer cannot accept any liability for personal injury or damage to property resulting from failure to adhere to these instructions.
- The dryer must be earthed as prescribed by law.
- Do not use extension leads or multiple adaptors.
- Before any maintenance on the dryer disconnect it from the mains supply.
- Do not operate the dryer if it has been damaged during transport. Contact one of our After-Sales Service technicians.
- Mains cable replacement is only to be carried out by After-Sales Service.
- After installation access to the mains plug has to be guaranteed, or the all-pole disconnection has to be possible with a switch.

## 3. Installation

- Do not install your dryer where it can be subject to extreme conditions, such as: poor ventilation, temperatures around freezing or above 35° C.
- Before running the first cycle ensure the water container and heat exchanger are correctly positioned.
- Only for water container top version: if possible use a hose to drain the water directly into the domestic plumbing system. This will avoid having to empty the water container at the end of each drying cycle since the condensation water can be directly drained away. See also chapter "Drainage System".
- Take care not to install the dryer on a deep-pile carpet.
- Take care not to trap the mains cable between the dryer and the wall.

## Stability:

When installing the dryer always carefully level the dryer adjusting the four feet and check the correct levelling with a spirit level.

## To built in the dryer

Remove the work-top and replace it with the Built-In kit UBS 10 (according to Eec Electrical Regulations), available at your dealer.

## Stacking kit

Your dryer can be stacked on top of your front loading washing machine. The type of stacking kit is stated in the Instruction for use of your washing machine or pls. contact your dealer or our After Sales Service.

## Minimum housing dimensions:

Width: 600 mm

Height: 850 mm

Depth: 600 mm



# ELECTRICAL CONNECTION

## 1) For Great Britain only

**Warning - this appliance must be earthed**

### Fuse replacement

If the mains lead of this appliance is fitted with a BS 1363A 13amp fused plug, to change a fuse in this type of plug use an A.S.T.A. approved fuse to BS 1362 type and proceed as follows:

1. Remove the fuse cover (A) and fuse (B).
2. Fit replacement 13A fuse into fuse cover.
3. Refit both into plug.

### Important:

The fuse cover must be refitted when changing a fuse and if the fuse cover is lost the plug must not be used until a correct replacement is fitted.

Correct replacement are identified by the colour insert or the colour embossed in words on the base of the plug.

Replacement fuse covers are available from your local electrical store.

## 2) For the Republic of Ireland only

The information given in respect of Great Britain will frequently apply, but a third type of plug and socket is also used, the 2-pin, side earth type.

## 3) Socket outlet / plug (valid for both countries)

If the fitted plug is not suitable for your socket outlet, please contact Whirlpool Service for further instruction. Please do not attempt to change plug yourself. This procedure needs to be carried out by a qualified Whirlpool technician in compliance with the manufactures instructions and current standard safety regulations.

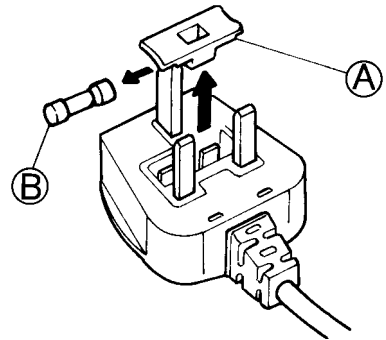

# PRECAUTIONS AND GENERAL RECOMMENDATIONS

## 1. Packing



The packing box may be fully recycled as confirmed by the recycling symbol .

## 2. Energy saving tips

- Always dry a full load: depending on the type of laundry and the programme/drying time.
- By preference use the maximum spin speed allowed by your washing machine, since draining the water mechanically requires less energy. You will save time and energy when running your drying cycle.
- Do not overdry the laundry.
- Clean the lint filter after **every** drying cycle.
- Place your dryer in a room with a temperature between 15° C and 20° C. In case of higher temperature ventilate the room.
- Always select the correct programme/drying time for the load in order to obtain the desired drying results.
- Select the *gentle* option only with small loads.
- When drying cotton, for example, dry *iron dry* and *cupboard dry* loads together. Start with the *iron dry* programme/drying time setting, remove the laundry to be ironed at the end of that cycle and dry the remainder of the load on the *cupboard dry* setting.

## 3. Disposing of packaging and old Dryer:

The dryer is built from reusable materials. The dryer must be disposed of in compliance with local waste disposal regulations.

- Before scrapping, cut off the power cable so that the dryer cannot be connected to the mains.

## 4. Child safety:

Children must not be allowed to play with the dryer.

## 5. General recommendations:

- Always set the programme/time selector knob to the "0" position after use. This prevents the dryer from being switched on accidentally.
- Before cleaning or carrying out maintenance, switch off the dryer and disconnect it from the mains supply.
- To clean the outside of the dryer, use a neutral detergent and a damp cloth.
- Do not use abrasive detergents.
- Wipe away lint from the door seal and the door using a damp cloth.
- If the lint filter mesh is clogged, clean it with water and a soft brush.
- Since lint can go through the filter it is necessary to clean, from time to time, the complete filter area (including below the filter) with a brush, a damp cloth or with a vacuum cleaner.
- If necessary, the power cable may be replaced with an identical one obtained from our After-Sales Service. The power cable must only be replaced by a qualified technician.

### EC Declaration of Conformity

- This dryer has been designed, constructed and distributed in compliance with the safety requirements of EC Directives:
  - 73/23/EEC Low Voltage Directive
  - 89/336/EEC EMC Directive
  - 93/68/EEC CE Marking Directive.



- The dryer must only be used in the household for the prescribed uses.

# DESCRIPTION OF THE DRYER

- A. Work top.
- B1. Water Container bottom version or
- B2. Water Container top version.
- C. Contact pin.
- D. Door:  
To open the door: pull the handle.  
To close the door: push gently until closed.
- E. Filter.
- F. Child Safety Lock.
- G. Button for heat exchanger flap opening.
- H. Heat exchanger.

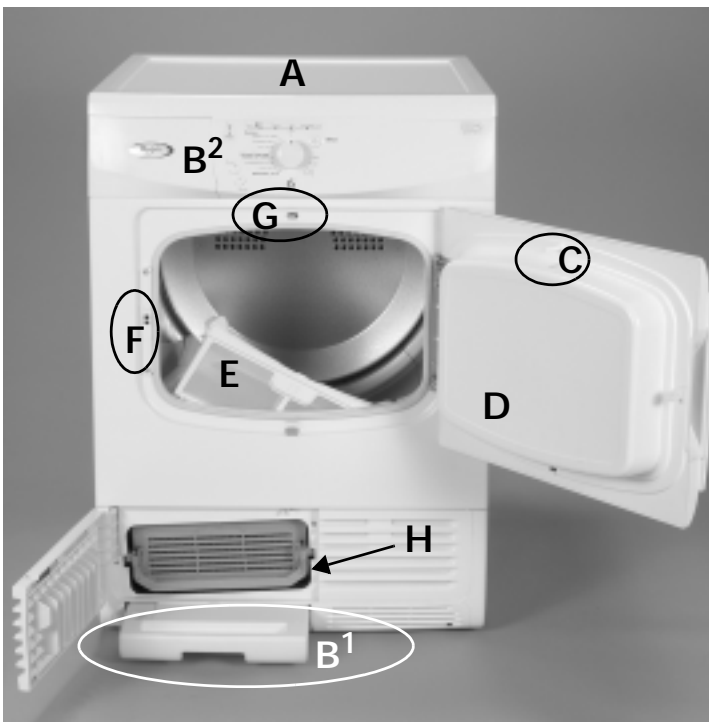

## Reminder - Maintenance and Cleaning

### Clean the lint filter at the end of every drying cycle.

- Open the door
- Pull the filter upwards
- Open the filter
- Remove lint using a soft brush or your fingertips
- Close the filter
- Push the filter back into place.

## Heat exchanger

### Clean the heat exchanger at least every 3 months (See "HEAT EXCHANGER" chapter).

- Wipe away any lint/fluff from the door seal and interior using a damp cloth.

# DRAINAGE SYSTEM

For water container top only

To avoid having to empty the water container at the end of each cycle, the condensation water can be drained away.

**Note:** Normally the drain hose is not supplied; the accessory AMH 883 kit, available at your dealer or our After Sales Service, should be used.

**The connection for direct draining is at the rear of the dryer.**

- A. Place an absorbent cloth underneath to collect water spillage.
- B. Remove the hose located at the lower rear part of the dryer and insert it in the nearby hole.
- C. Fix the hose (length: 1.5 m) to the outlet connection. The height difference between the two drainage connections should not exceed 1m.

**Notice:** To avoid siphoning, the end of the hose must not be immersed in the drain water. Avoid bending and twisting the hose.

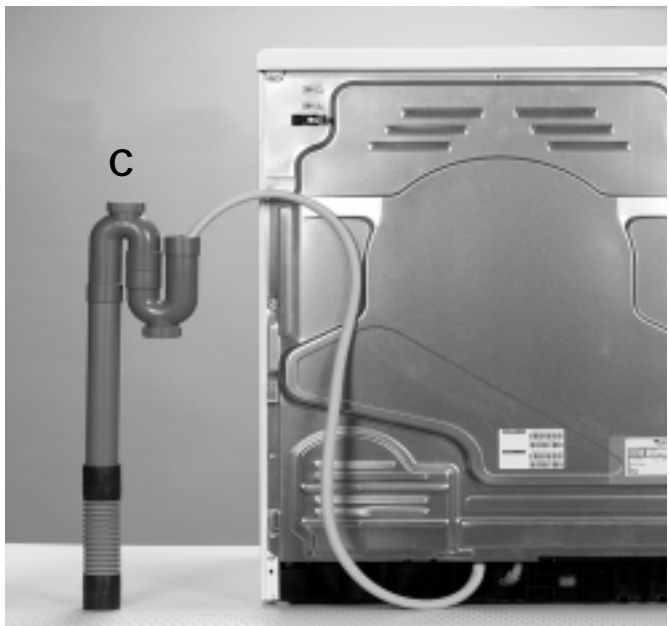
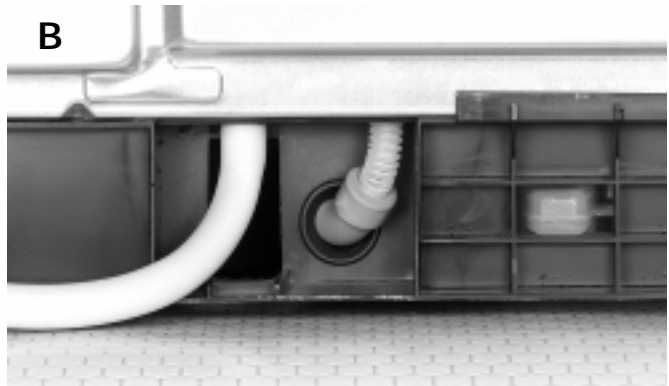

# DOOR REVERSIBILITY / CHILD SAFETY LOCK

## Door Reversibility

- A. Unplug the dryer.
- B. Open the door.
- C. Using a spanner, turn the contact pin in the upper part of the door by 90° and remove it.
- D. Unscrew the 2 screws of the door hinge and remove the door.
- E. Removing the door lock:  
Unscrew the 2 screws above and below the door lock system.  
Lift the door lock from the bottom, sliding it upwards about 1.5 cm, and remove it.
- F. Reverse the door:  
Fasten the door on the desired side with the 2 screws.
- G. Insert the door lock system on the opposite side of the hinge fixation and push it down 1.5 cm.
- H. Fix the 2 screws above and below the door lock system.
- I. Take care not to reverse the sense of the door lock system. The child safety must be above the locking mechanism.
- J. Replace the contact pin in the inside of the door (top).

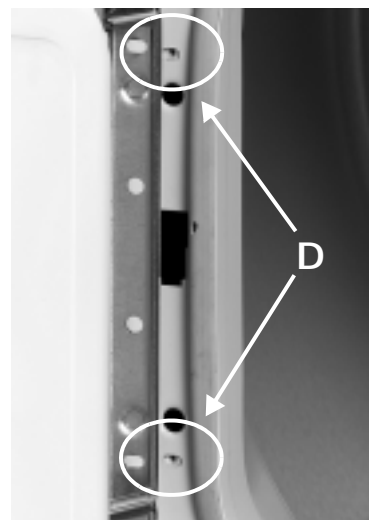
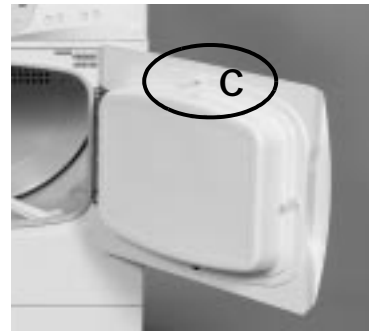

## Child Safety Lock

### How to use the child safety lock

1. Open the door.
2. Using a coin or a screwdriver, turn the plastic screw (J) clockwise 90°.  
Slot vertical: the door cannot be locked.  
Slot horizontal: the door can be locked.

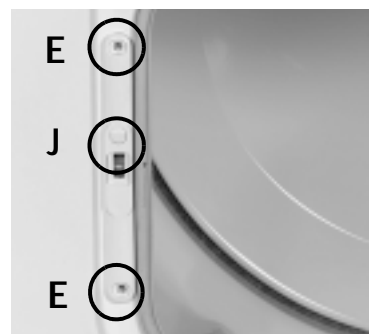

# HEAT EXCHANGER

Before cleaning or carrying out maintenance, switch off the dryer.

Clean the heat exchanger at least every three months, proceeding as follows:

- A. Open the door and press the heat exchanger flap button on the bottom of the door entrance.
- B. The heat exchanger flap opens.
- C. Fold the heat exchanger handle upwards to the horizontal position and remove the heat exchanger.
- D. Clean the heat exchanger under running water by turning it around to reach all sides.
- E. Wipe away dust and lint from the seals and the heat exchanger.
- F. Remove the lint in the heat exchanger housing. Keep the drainage hole (left side in front in the housing) free from lint.
- G. Replace the heat exchanger in its housing (TOP or HAUT mark upwards) and press the handle.
- H. Close the flap.

The heat exchanger aluminium plates may become discoloured over time.

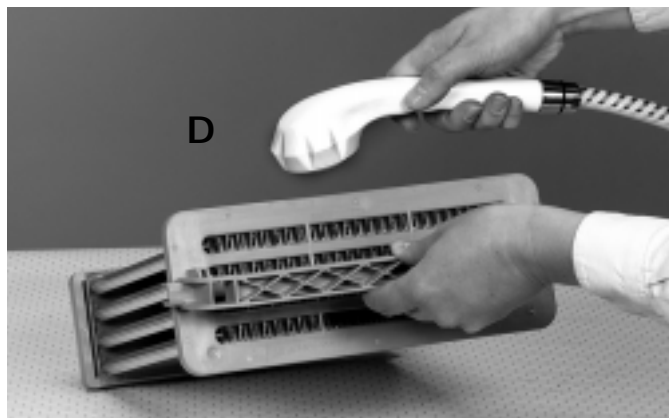
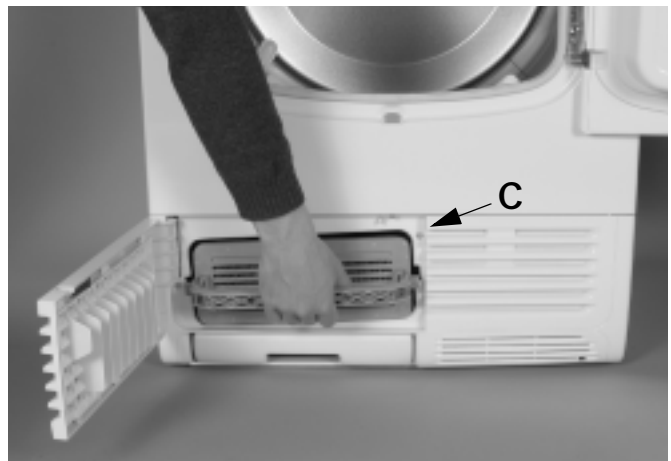
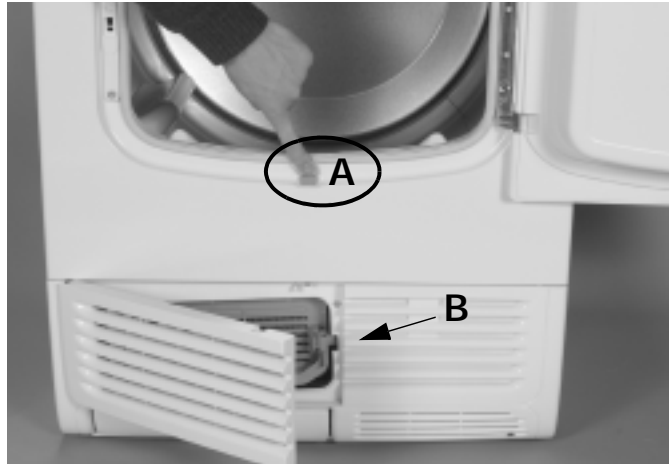



# TROUBLESHOOTING GUIDE / AFTER-SALES SERVICE

## Troubleshooting Guide

If a fault occurs, before contacting our After-Sales Service, make the following checks to try and remedy the problem:

### Drying takes too long / laundry is not dry enough:

- Was the correct programme selected?
- Was the inserted laundry too wet (Washing machine spin speed less than 800 rpm? When the spinning speed is less than 800 rpm the water container fault may occur during the drying cycle)?
- Is the lint filter dirty (filter indicator lamp on)?
- Is the heat exchanger dirty? (refer to the Instructions for use)
- Is the ambient temperature too high?
- Does "END" and "Anti-Crease" LED's are lights up? - The drying cycle is terminated, the laundry can be taken out.

### The dryer does not operate:

(after a power failure and/or interruption to the mains supply, always press the Start/Pause button).

- Is the plug properly inserted into the mains electricity socket?
- Is there a power failure?
- Has the fuse blown?
- Is the door properly closed?
- Has the programme been selected?
- Has the start delay option been selected?
- Has the **Start/Pause** button been pressed?

### Lint filter or water container indicator lamp light on:

- Is the lint filter clean?
- Is the water container empty?
- Is the water container correctly positioned?
- Is the heat exchanger clean?

### Water droplets underneath the dryer:

- Is the heat exchanger correctly positioned?
- Has any fluff on the heat exchanger seal been wiped away?
- Has any fluff on the door seal been wiped away?
- Has the water container been positioned correctly?

## After-Sales Service

If, after carrying out the above checks the malfunction persists or appears again, turn the dryer off and call our After-Sales Service (refer to guarantee).

### Please specify:

- The nature of the fault.
- The dryer type and model.
- The service code (the number after the word Service on the adhesive rating plate) on the right-hand side when the door is open.
- Your full address and phone number.

**SERVICE** 0000 000 00000

