

SAFETY INSTRUCTIONS

Before using the appliance, read these safety instructions. Keep them nearby for future reference.

These instructions and the appliance itself provide important safety warnings to be observed at all times. The manufacturer declines any liability for failure to observe these safety instructions, for inappropriate use of the appliance or incorrect setting of controls.

⚠ **WARNING:** If the hob surface is cracked, do not use the appliance - risk of electric shock.

⚠ **WARNING:** Danger of fire: Do not store items on the cooking surfaces.

⚠ **CAUTION:** The cooking process has to be supervised. A short cooking process has to be supervised continuously.

⚠ **WARNING:** Unattended cooking on a hob with fat or oil can be dangerous - risk of fire. NEVER try to extinguish a fire with water: instead, switch off the appliance and then cover flame e.g. with a lid or a fire blanket.

⚠ Do not use the hob as a work surface or support. Keep clothes or other flammable materials away from the appliance, until all the components have cooled down completely - risk of fire.

⚠ Metallic objects such as knives, forks, spoons and lids should not be placed on the hob surface since they can get hot.

⚠ Very young children (0-3 years) should be kept away from the appliance. Young children (3-8 years) should be kept away from the appliance unless continuously supervised. Children from 8 years old and above and persons with reduced physical, sensory or mental capabilities or lack of experience and knowledge can use this appliance only if they are supervised or have been given instructions on safe use and understand the hazards involved. Children must not play with the appliance. Cleaning and user maintenance must not be carried out by children without supervision.

⚠ After use, switch off the hob element by its control and do not rely on the pan detector.

⚠ **WARNING:** The appliance and its accessible parts become hot during use. Care should be taken to avoid touching heating elements. Children less than 8 years of age shall be kept away unless continuously supervised.

⚠ The food must not be left in or on the product for more than one hour before or after cooking.

PERMITTED USE

⚠ **CAUTION:** the appliance is not intended to be operated by means of an external switching device, such as a timer, or separate remote controlled system.

⚠ This appliance is intended to be used in household and similar applications such as: staff kitchen areas in shops, offices and other working environments; farm houses; by clients in hotels, motels, bed & breakfast and other residential environments.

⚠ No other use is permitted (e.g. heating rooms).

⚠ This appliance is not for professional use. Do not use

IMPORTANT TO BE READ AND OBSERVED

the appliance outdoors.

⚠ **WARNING:** Induction hob may generate the acoustic sound when something is left on the control panel. Switch off the cooktop through the ON/OFF button.

INSTALLATION

⚠ The appliance must be handled and installed by two or more persons - risk of injury. Use protective gloves to unpack and install - risk of cuts.

⚠ Installation, including water supply (if any), electrical connections and repairs must be carried out by a qualified technician. Do not repair or replace any part of the appliance unless specifically stated in the user manual. Keep children away from the installation site. After unpacking the appliance, make sure that it has not been damaged during transport. In the event of problems, contact the dealer or your nearest After-sales Service. Once installed, packaging waste (plastic, styrofoam parts etc.) must be stored out of reach of children - risk of suffocation. The appliance must be disconnected from the power supply before any installation operation - risk of electric shock. During installation, make sure the appliance does not damage the power cable - risk of fire or electric shock. Only activate the appliance when the installation has been completed.

⚠ Carry out all cabinet cutting operations before fitting the appliance and remove all wood chips and sawdust.

ELECTRICAL WARNINGS

⚠ It must be possible to disconnect the appliance from the power supply by unplugging it if plug is accessible, or by a multi-pole switch installed upstream of the socket in accordance with the wiring rules and the appliance must be earthed in conformity with national electrical safety standards.

⚠ Do not use extension leads, multiple sockets or adapters. The electrical components must not be accessible to the user after installation. Do not use the appliance when you are wet or barefoot. Do not operate this appliance if it has a damaged power cable or plug, if it is not working properly, or if it has been damaged or dropped.

⚠ Installation using a power cable plug is not allowed unless the product is already equipped with the one provided by the Manufacturer.

⚠ If the supply cord is damaged, it must be replaced with an identical one by the manufacturer, its service agent or similarly qualified persons in order to avoid a hazard - risk of electric shock.

CLEANING AND MAINTENANCE

⚠ **WARNING:** Ensure that the appliance is switched off and disconnected from the power supply before performing any maintenance operation; never use steam cleaning equipment - risk of electric shock.

⚠ Do not use abrasive or corrosive products, chlorine-based cleaners or pan scourers.

DISPOSAL OF PACKAGING MATERIALS

The packaging material is 100% recyclable and is marked with the recycle symbol .

The various parts of the packaging must therefore be disposed of responsibly and in full compliance with local authority regulations governing waste disposal.

DISPOSAL OF HOUSEHOLD APPLIANCES

This appliance is manufactured with recyclable or reusable materials. Dispose of it in accordance with local waste disposal regulations. For further information on the treatment, recovery and recycling of household electrical appliances, contact your local authority, the collection service for household waste or the store where you purchased the appliance. This appliance is marked in compliance with European Directive 2012/19/EU, Waste Electrical and Electronic Equipment (WEEE) and with the Waste Electrical and Electronic Equipment regulations 2013 (as amended).

By ensuring this product is disposed of correctly, you will help prevent negative consequences for the environment and human health.

The symbol  on the product or on the accompanying documentation indicates that it should not be treated as domestic waste but must be taken to an appropriate collection center for the recycling of electrical and electronic equipment.

ENERGY SAVING TIPS

Make the most of your hot plate's residual heat by switching it off a few minutes before you finish cooking.

The base of your pot or pan should cover the hot plate completely; a container that is smaller than the hot plate will cause energy to be wasted.

Cover your pots and pans with tight-fitting lids while cooking and use as little water as possible. Cooking with the lid off will greatly increase energy consumption.

Use only flat-bottomed pots and pans.

DECLARATION OF CONFORMITY

This appliance meets Ecodesign requirements of European Regulation 66/2014 and The Ecodesign for Energy-Related Products and Energy Information (Amendment) (EU Exit) Regulations 2019 in compliance with the European standard EN 60350-2.

NOTE

People with a pacemaker or similar medical device should use care when standing near this induction cooktop while it is on. The electromagnetic field may affect the pacemaker or similar device. Consult your doctor, or the manufacturer of the pacemaker or similar medical device for additional information about its effects with electromagnetic fields of the induction cooktop.

The Manufacturer, Whirlpool Management Emea S.r.l., declares that this I300 EMEA model of household appliance with radio equipment is compliant with directive 2014/53/UE and Radio Equipment Regulations 2017.

The complete text of the declaration of conformity is present at the following website: <https://docs.whirlpool.eu>.

The radio equipment operates in the 2.4 GHz ISM frequency band, the maximum radio-frequency power transmitted does not exceed 20 dBm (e.i.r.p.).

This product includes certain open source software developed by third parties. The open source license usage statement is available at the following website: <https://docs.whirlpool.eu>.



ELECTRICAL CONNECTION

Electrical connection must be made before connecting the appliance to the electricity supply.

Installation must be carried out by qualified personnel who know the current safety and installation regulations. Specifically, installation must be carried out in compliance with the regulations of the local electricity supply company.

Make sure the voltage specified on the data plate located on the bottom of the appliance is the same as that of the home.

Regulations require that the appliance be earthed: use conductors (including the earth conductor) of the appropriate size only.

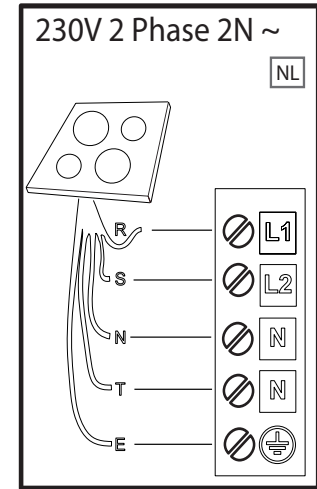
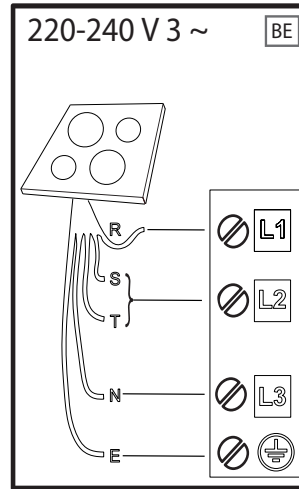
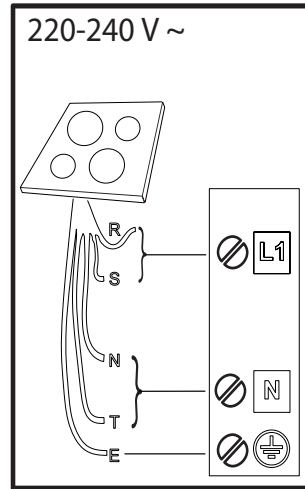
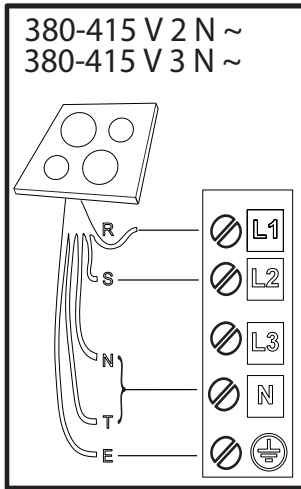

R

black-nero-negro-preto-μαύρος-must-melns-juodas-czarny-schwarz-noir-zwart-negru-черно-црн-črna-срно-черный-чорний-қара-černá-čierna-fekete-svart-musta-svart-sort-siyah-dubh-svartur

S

brown-marrone-marrón-marrom-καφέ-pruun-brūns-rudas-brązowy-braunen-brun-bruin-marò-кафяв-браон-rjava-smeđ-коричневый-коричневий-қоңыр-hnědý-hnedý-barna-brunt-ruskea-brunt-brun-kahverengi-donn-brúnn

T

blue (gray)-blu (grigio)-azul (gris)-azul (cinza)-μπλε (γκρι)-sinine (hall)-zila (pelēka)-mėlyna (pilkas)-niebieski (szary)-blau (grau)-bleu (gris)-blauw (grijs)-albastru (gri)-синьо (сиво)-плава (сива)-modro (sivo)-plava (siva)-синий (серый)-синий (сірий)-көк (сұр)-modrý (šedá)-modrý (sivá)-kék (szürke)-blå (grå)-sininen (harmaa)-blå (grå)-blåt (gråt)-mavi (gri)-gorm (liath)- blár (grár)

 = **E**

yellow/green-giallo/verde-amarillo/verde-amarelo/verdekίτρινο/πράσινο-kollane/roheline-dzeltens/zař-geltona/žalia-žółty/zielony-gelb/grün-jaune/vert-geel/groen-galben/verde-жълто/зелено-жүто/зелена-румено/zeleno-žuto/zelena-желтый/зеленый-жовтий/зелений-жасыл/сары-žlutá/zelená-žltá/zelená-sárga/zöld-gul/grønn-keltainen/vihreä-gul/grön-gul/grøn-sarı/yeşil-bui/glas- gulur/grænn

N

blue-blu-azul-azul-μπλε-sinine-zila-mėlyna-niebieski-blau-bleu-blauw-albastru-синьо-плава-modro-plava-синий-синий-көк-modrý-modrý-kék-blå-sininen-blå-blåt-mavi-gorm- blár



THANK YOU FOR BUYING A WHIRLPOOL PRODUCT
In order to receive a more complete assistance, please register your product on www.whirlpool.eu/register.

PLEASE SCAN THE QR CODE ON YOUR APPLIANCE IN ORDER TO REACH MORE INFORMATION

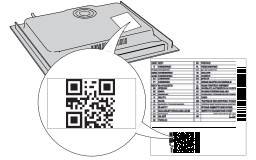

Before using the appliance carefully read the Safety Instruction.

PRODUCT DESCRIPTION

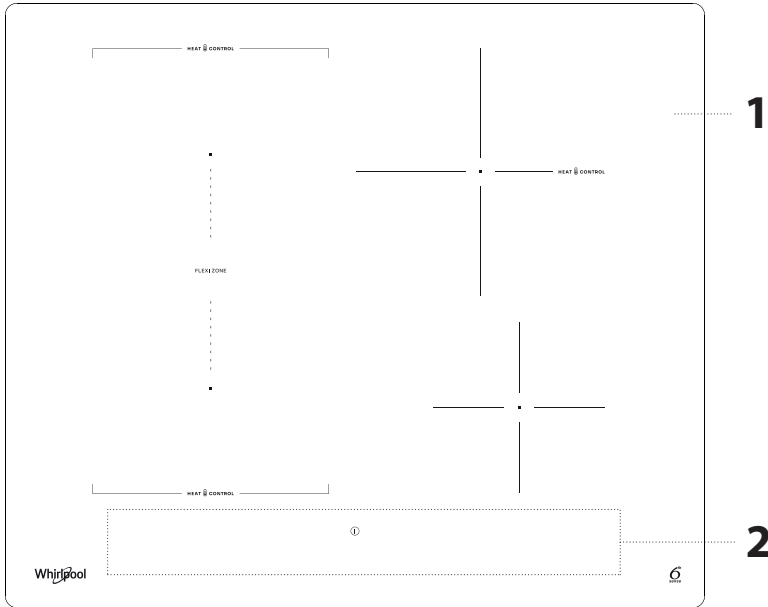

- 1. Cooktop
- 2. Control panel

CONTROL PANEL

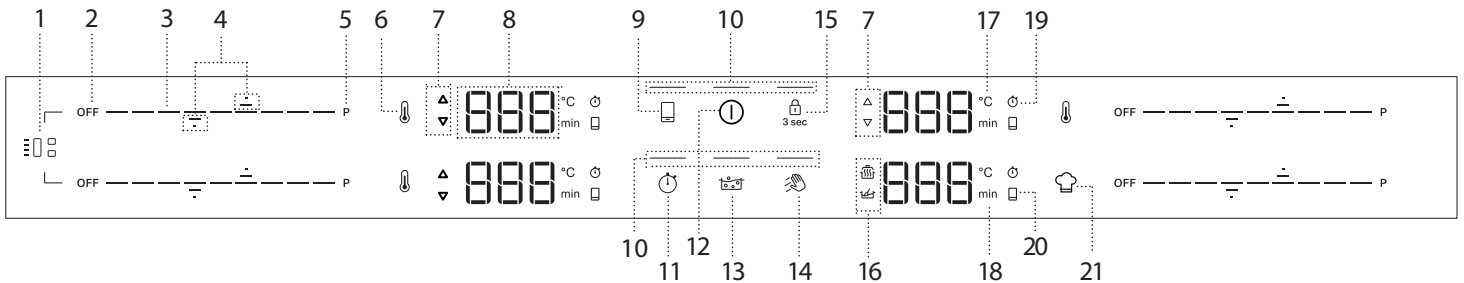





- | | | |
|--|--|--|
| <ul style="list-style-type: none"> 1. Flexi Zone button 2. Cooking zone OFF button 3. Scroll keypad 4. Arrows to set Temperature/Timer 5. Fast heating button (Booster) 6. Heat control button 7. Preheat/Cool down indicator | <ul style="list-style-type: none"> 8. Cooking zone display 9. Remote Key 10. Indicator light – function active 11. Timer button 12. On/Off button 13. Boil button 14. Wipe button | <ul style="list-style-type: none"> 15. Key lock button – 3 seconds 16. Symbols/Activation of special functions 17. Temperature indicator (Degree Celsius) 18. Minutes indicator 19. Timer indicator symbol 20. Remote control indicator 21. Special function button |
|--|--|--|

NOTE: Press ON/OFF button (9); all the available functions will become visible for a few moments, after which only the main ones will remain active; the others can be used, and will be activated, subsequently, during use of the device.

IMPORTANT: all the available functions will be illuminated in dim light intensity, which will become more intense only when they are activated.

ACCESSORIES

Only use pots and pans made from ferromagnetic material suitable for induction hobs. Check for the  symbol (generally stamped on the bottom) to determine whether a pot is suitable. A magnet may also be used to check whether the cookware base is magnetic.

COOKWARE	MATERIAL	PROPERTIES
Recommended cookware 	Base is made of stainless steel with sandwich design, enamelled steel, cast iron.	Ensures optimum efficiency, heats up quickly, and distributes heat evenly.
Suitable cookware 	Base is not fully ferromagnetic (magnet sticks only in a portion of the cookware base).	Only the ferromagnetic area heats up. As a result, may heat up less quickly and heat may be distributed less evenly.
Suitable cookware 	Ferromagnetic base contains areas with aluminium or has a recessed area in the center.	The ferromagnetic area is smaller than the actual cookware base area. As a result, less power may be delivered and cookware may not heat sufficiently. Cookware may not be detected.
Not suitable	Normal thin steel, glass, clay, copper, aluminium and other non-ferromagnetic materials, cookware with rubber feet	Cookware is not detected and will not heat up.

NOTE: All cookware must have a flat base. Periodically check the base for any sign of warping, as some cookware may undergo deformation due to high heat.

ADAPTERS FOR POTS/PANS UNSUITABLE FOR INDUCTION

The use of adapter plates affects efficiency and therefore increases the time required to heat water or food. Make sure that the ferromagnetic diameter of the cookware base aligns with both the diameter of the adapter plate

and the diameter of the cooking zone. If these measurements don't match, it can significantly decrease efficiency and performance. Not following these guidelines could lead to heat build up that is not effectively transferred to the pot or pan, potentially causing blackening of the plate and hob.

EMPTY POTS AND PANS

The hob is equipped with an internal safety system that activates the "Automatic off" function when too high temperature is detected. The use of empty pots and pans with a thin base is not recommended. However, when doing so, the temperature might rise quicker than the time needed for the "Automatic off" to be triggered promptly, with the risk of damaging the pan or the hob surface. If this occurs, do not touch the pan nor the hob surface and wait for all components to cool down. If any error message is displayed, call the Service Centre.

SUITABLE SIZE OF PAN/POT BASE FOR THE DIFFERENT COOKING ZONES

To ensure that the hob works properly, use pots of a suitable base diameter for each zone (refer to the table below). Please note that cookware manufacturers often provide the size of the upper diameter of the cookware, rather than the base diameter.

To ensure that the hob works with the expected performance, always use a cooking zone with a size matching the ferromagnetic size of the cookware base. Place the pan/pot making sure it is well centred on the cooking zone in use. It is recommended not to use pots larger than the size of the cooking zone.

COOKWARE USAGE BY ZONE

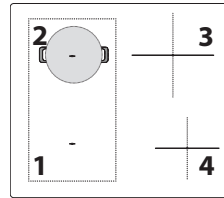

Zone	Suitable cookware shape	Suitable ferromagnetic base (cm)
1 or 2	Round or Square	16-21
3	Round	16-21
4	Round	10-15
1+2 (Flexi Zone)	Oval or Rectangular	Short side 16-21 Long side 24 - 38

FIRST TIME USE

POWER MANAGEMENT

At the time of purchase, the hob is set to the maximum power. Adjust the setting concerning the limits of your home's electrical system as described in the following paragraph.

NOTE: Depending on the power selected for the hob, some of the cooking zone power levels and functions (e.g. boil or fast heating) could be automatically limited to prevent the selected limit from being exceeded.

The table below shows the power used by each zone for each function to help you understand the possible limitations in the usage based on the chosen power setting.

ZONE	1 or 2	1 + 2	3	4
POWER LEVEL 18 (KW)	2.2	2.2	2.5	1.5
BOOSTER (KW)	3.7	3.7	3.7	2.2
HEAT CONTROL (KW)	1.4	NA	1.4	NA
BOIL & COOK (KW)	3.0	NA	3.0	NA
MELTING (KW)	NA	NA	NA	0.045
KEEP WARM (KW)	NA	NA	NA	0.145

Examples with reference to the values in the table above:

If you set the "Power management setting" of your hob to 2.5 kW, booster (fast boil) of zone 1 or 2 or 1+2 or 3 is automatically limited to level 18 since there is no more power available (2.5 kW available power lower than 3.7kW power necessary for the booster function). Instead, if you set zone 4 with booster, you will still be able to use 0.3kW on other zones (2.5kW available power - 2.2kW used power = 0.3kW remaining available power).

If you set the "Power management setting" of your hob to 2.5 kW and you set one zone among zones 1 or 2 or 1+2 or 3 at level 18, you cannot activate other zones at the same time on the hob not to overcome the power available (2.5 kW available power - 2.5 kW necessary power from level 18 = 0kW, no remaining power). In this case, you may reduce the power level of the first zone activated (e.g., power level 13) in order to have some remaining power available to be used on other zones (e.g., level 10).

Setting Menu: Changing the basic settings

Once you have connected the device to the mains power supply, you can change the default settings by entering the Setting Menu:

- Press and hold the On/Off button (ⓘ) to turn on the hob.
- Press the Key-lock button (Ⓚ) for at least 6 seconds to enter the setting menu. Ignore the key-lock activation sound that will occur after 3 seconds of pressure.
- The setting type (eg."PL") will be shown on the top-left cooking zone display, and its default (or eventually current) value (eg."2_5") will be shown the bottom-left cooking zone display.
- You can select the setting type by using up (⬆) and down (⬇) arrows of the top-left cooking zone. You can change its value from the possible ones by using up (⬆) and down (⬇) arrows of the bottom-left cooking zone. See the table below for the setting types, default values and possible values.
- Press the On/Off button to confirm.
- Without the confirmation the hob will exit from the setting menu and return to the previous values within 30 seconds.

ORDER	SETTING TYPE	TOP-LEFT	BOTTOM-LEFT (DEFAULT)	POSSIBLE VALUES
1	Power Limitation	PL	2_5	2_5 kW; 4_0 kW; 6_0 kW; 7_4 kW
2	Audio tone	Aud	On	On/Off
3	Demo mode	dE	Off	Off/On

WI-FI SETUP

Function currently not available.

DAILY USE

SWITCHING THE HOB ON/OFF

To turn on the hob, press and hold the power button for up to 3 seconds. To turn the hob off, press the same button again, and all cooking zones will be deactivated.

POSITIONING

Do not cover the control panel symbols with the cooking pot.

Please note: In the cooking zones close to the control panel, it is advisable to keep pots and pans inside the markings (taking both the bottom of the pan and the upper edge into consideration, as this tends to be larger).

This prevents excessive overheating of the keypad. When grilling or frying, please use the rear cooking zones wherever possible.



ACTIVATING/DEACTIVATING COOKING ZONES AND ADJUSTING POWER LEVELS



To activate the cooking zones:

Upon turning the product ON, the scroll keypad (SLIDER) of all available cooking zones will turn ON in low luminosity. Place your finger on the scroll keypad (SLIDER) of the zone you would like to activate and gently slide it horizontally to the right if you would like to increase the power level or, to the left to decrease the power level. You will notice that the control keypad segments will turn to high luminosity based on the selected power level and the display digits will show the number corresponding to the power level selected (ranging 1 to 18). The "P" button can be used to select the fast heating function (Booster) to quickly boil water.

To deactivate the cooking zones:

Select the "OFF" button at the beginning of the scroll keypad. Water spillage, food overflow and/or object positioned on the control panel buttons can mimic one's finger, which can accidentally activate or deactivate any of the hob buttons. If such presence is not removed within 8 seconds, the hob automatically switch off while producing a sound.

CONTROL PANEL LOCK

The control panel lock function is designed to lock the hob settings, thus preventing it from accidentally change any setting and switching on. You may need to use this function for various reasons, such as in case of possible liquid or food spillage while cooking, or for safety reasons in case of accidental interaction by children with the hob to prevent any accidental turning on of the hob. To use the control panel lock function press and hold the  button for 3 seconds. The button switches to high luminosity and a beep and a light

above the symbol indicate that this function has been activated. To unlock the controls, repeat the activation procedure.

NOTE: The control panel is locked except for the switching off function. If you turn off your hob with the control panel lock active, after pressing the ON/OFF button keep pressing for 3sec the lock button to unlock the hob.

WIPE FUNCTION

The wipe function temporarily locks the buttons of the user interface to prevent settings changes during the cleaning process. The function doesn't interrupt the cooking process.

Wipe function helps to prevent any sounds if water spills over the user interface during the cooking process or during your habitual cleaning.

For safety reasons, the ON/OFF button can be activated, even involuntarily, during cleaning.





To activate the Wipe function:

1. Press Wipe button . An acoustic signal sound will be provided when the function is active.
2. The LED above the button will turn on and stay solid while the button is flashing for the entire duration of the function activity.
3. The control panel remains locked for 30 seconds.

TIMER

The timer controls all the active cooking zones.

To activate the timer:

1. Select the cooking zone and set the desired power level.
2. The timer button will turn on approximately 5 seconds after the cookware is recognized. Press it until an indicator light turns on in line with the specific symbol on the chosen cooking zone.
3. Use the up  and down  arrows to set the time. The time will change from 000 seconds to 30 minutes, increasing by 1 minute each time; from 30 to 150 minutes, the time will increase in steps of 5 minutes. If you need to change the time by 10 minutes, use the side dashes. The dash on the left will subtract 10 minutes, while the dash on the right will add 10 minutes.
4. To confirm the time set, you can press the clock button , or the time will be automatically confirmed after 5 seconds of no action.
5. You can change the time at any point and activate multiple timers simultaneously.
6. During the countdown, tap with your finger on the slider to see the power level. Tap the up  or down  arrow to see the set temperature. After 3 seconds, the countdown will reappear.
7. Once the timer has elapsed, a beep will sound, and the cooking zone will switch off automatically.

To deactivate the timer:

Press the down arrow  until it shows 000, and it will be deactivated after 5 seconds.

TIMER INDICATOR

This LED (when ON) indicates that the timer has been set for the cooking zone.

COOKING ZONES AND FUNCTIONS MAXIMUM WORKING TIME

Power level or function	OFF	1-3	4-6	7-9	10-12	13-15	16-18	Booster *	Booster **	Melting	Keep warm
Maximum working time	-	8 h	6 h	4 h	3 h	2 h	1.5 h	10 min.	5 min.	8 h	8 h
Power level after time-out	-	0	0	0	0	0	0	18	18	0	0

* Cooking Zone 1, 2, 3

** Cooking Zone 4

Examples regarding the values in the table above:

If you turn on a cooking zone and set its power to level 14, the cooking zone will continue working for a maximum of 2 hours. After 2 hours, the power level will reduce to level 0 and the cooking zone will turn off automatically. If there are no other active cooking zone, and there is no interaction with the control panel buttons within 30 seconds, the hob will turn off automatically.

If you activate the Booster function on cooking zone 4, it will automatically reduce to power level 18 after 5 minutes. Instead, if you activate the Booster function on cooking zones 1, 2, or 3 it will automatically reduce to power level 18 after 10 minutes. After 1.5 hours, the power level will reduce to level 0 and the cooking zone will turn off automatically. If there are no other active cooking zone, and there is no interaction with the control panel buttons within 30 seconds, the hob will turn off automatically.

FUNCTIONS

P BOOSTER FUNCTION

Booster is a special mode with a higher power than level 18, that allows the fastest heating. Depending on the zone used, this mode can have a different duration (refer to table below). After the Booster time has elapsed, the power will be automatically reduced to level 18.

IMPORTANT: Do not use with an empty pan or oil/butter. This function is perfect for boiling water.

NOTE: Depending on the Power Management setting, the Booster function may not be available for certain cooking zones. Also, if you set one cooking zone to Booster and then activate another zone, the first one will be reduced to the maximum level available, even much lower than level 18, to allow the second one to be used. The second cooking zone will be set or limited based on the remaining power available on that side of the hob.

Additionally, please keep in mind that the power delivery may vary based on the size and material of the cookware being used.

ZONE DESCRIPTION

Zone	Nominal power (Level 18, kW)	Power Booster (kW)	Booster Duration (min.)
1 or 2	2.5	3.7	10
3	2.5	3.7	10
4	1.5	2.2	5
1+2 (Flexi Zone)	2.2	3.7	10

NOTE: values in the table refer to testing conditions as described in the normative standard for evaluating the performance of cooking appliances. The power shown may vary depending on the size or material of the cookware used.

☐ FLEXIBLE COOKING ZONE (FLEXI ZONE)

With this function you can combine two cooking zones into a single, longer one, to accommodate rectangular, oval, or elongated cookware, and use a single setting for the whole combined zone.

To ensure proper performance, use only pots and pans with a ferromagnetic base long enough to cover the two zones at the same time. Place the cookware in the centre of the flexible cooking rectangular area.

Please refer to the figure below for examples of correct and incorrect usage.

NOTE: A large round pot used in the middle may heat up less quickly and heat may be distributed less evenly.

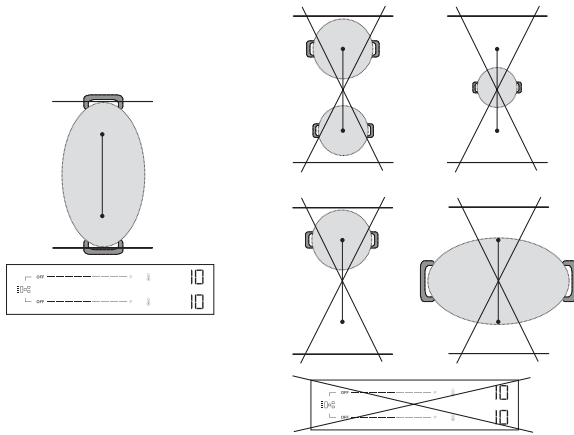

IMPORTANT: With pots and pans with a ferromagnetic base of 21 cm or smaller, it is recommended to use the single cooking zones **without activating the flexible cooking mode (Flexi Zone)**. Place the cookware either on the front or rear zone and activate the zone.

Please refer to the figure below for examples of correct and incorrect usage.

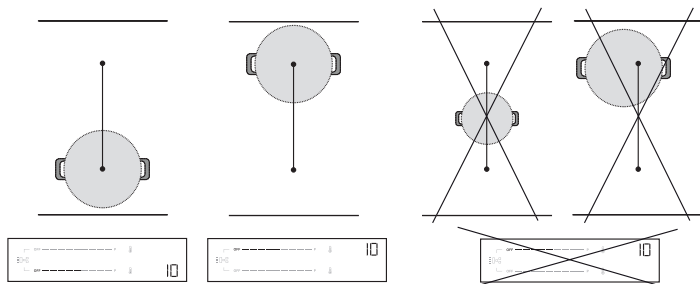

Flexi Zone used as two individual zone's

When used with two pots or pan at the same time, it is recommended to place the first one on the rear zone and the other one on the front zone (refer to figure below). In this case, the zones shall be activated **without using the flexible cooking mode (Flexi Zone)**.

For optimal performance, make sure that both cookware are centred in their respective zones. Do not move one pot/pan off-centre to make space for the other one. When placing the cookware, do not go outside the cooking zone area nor on top of the control panel.

Please refer to the figure below for examples of correct and incorrect usage.

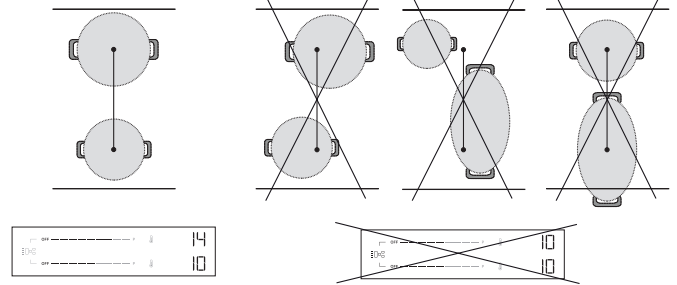

AUTOMATIC FUNCTIONS

This hob provides you some automatic functions to assist you in the cooking process. Please note that they may not be available depending on the power management setting (see Power Management section). For example, if the power management has been set to 2.5kW and some zone is already on use, the remaining power might not be enough to activate an automatic function. The hob will notify you with an acoustic feedback.

MELTING

The function automatically sets the ideal power for melting. This function allows you to melt delicate food, such as chocolate or butter, and maintain it melted without the risk of burning or sticking to the pot or pan.

KEEP WARM

The function automatically sets the ideal power for keeping food warm after cooking and before serving. Please note that liquids are reduced over time when keeping the food warm.

These automatic functions are only available on standard cooking zones (zones with the icon ☪).

How to activate automatic functions:

To activate the automatic functions, press the icon ☪. The display will show two dimly lit icons (☪) (keep warm) on the top and ☪ (melting) on the bottom.

Use the up (↑) and down (↓) arrows to select the desired function.

The display will show "A1" for melting and "A2" for keep warm and the corresponding icon will become brighter.

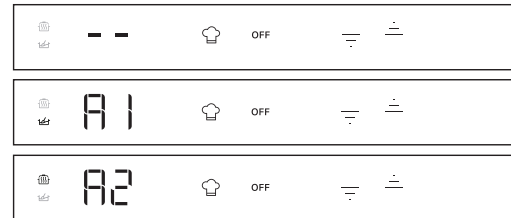

HEAT CONTROL - ASSISTED COOKING WITH TEMPERATURE

The function allows you to select and cook at your desired temperature, similarly to what you would do with an oven, rather than using standard power levels.













With this feature, the hob will automatically adjust the heat and maintain a stable cookware temperature, eliminating the need for constant adjustments.

This function is available only on cooking zones with the ☪ icon.

NOTE: The displayed temperature refers to the centre of the empty cookware. Depending on the specific cookware you are using, the temperature shown might be different from the actual cookware temperature. For optimal performance, it is advisable to place the cookware in the centre of the cooking zone and to activate the function when there is no 'residual heat' indicator ☪ present.

IMPORTANT: This function is not meant to be used for boiling water or deep-frying. Because of this, even if you select a temperature higher than 100 °C the water won't boil. Please, refer to "Assisted Boil" section or use the Booster function for quick boiling.

How to activate Heat Control:

1. Place the cookware on the zone with the icon .
2. Press the  icon.
3. Use the up arrow () to select the desired temperature. Default setting is 45° C. You may increase the temperature up to 200°C, according to your needs (refer to the table below for cooking tips). Use the down arrow () to reduce the temperature.
4. During the heat up phase, an up arrow () will flash next to the selected temperature.
5. The hob will notify you with an audible tone once the cookware has reached the set temperature and the up arrow () will stop flashing. Now you may add food.
6. After the set point has been reached, you can use the up () and down () arrows to adjust the selected temperature in steps of 5°C.
7. If the new selected temperature is lower than current one, a down arrow () will flash next to the selected temperature until the new set point has been reached. If the new selected temperature is higher than the current temperature, an up arrow () will flash next to the selected temperature until the new set point has been reached.
8. If you set a timer on a zone where the Heat Control function is active, the timer will start only after the set point is reached. The display will show the timer countdown instead of the temperature. During the countdown, tap the up  or down  arrow to see the set temperature. After 3 seconds, the countdown will reappear.

HEAT CONTROL - COOKING TIPS

Suggestions on cooking techniques for each temperature are provided in the table below.

LOW HEAT		MEDIUM HEAT		HIGH HEAT	
45°C 130°F	80°C 170°F	130°C 265°F	150°C 300°F	180°C 350°F	200°C 390°F
Melt (Chocolate, Butter)	Keep Warm	Gentle fry (Soffritto)	Deglaze	Scramble (Eggs)	Stir-fry/Toast
Defrost (Meat, Fish)	Thickening, Creaming (risotto)	Confit (Vegetables, Meat)	Caramelise (Sugar, Vegetables)	Stir-fry	Grill (Beef, Vegetables)
	Slow cooking (at low temp.)	Simmer	Sauté	Roast/Grill (Fish, Chicken)	Sear (Steak, Roast)
		Braise/Stew		Brown (Pancakes, Toast)	

Refer to app/website (add URL/QR code) for additional cooking tips. Please, refer to "Assisted Boil" section or use the Booster function for quick boiling.

NOTE:

- If you select a temperature higher than 100 °C the water won't boil.
- The system is able to monitor the cooking temperature, but it is always recommended to stay present when the hob is in use.
- Depending on the cooking zones activation sequence, Heat Control function might not be available. The hob will notify you with an acoustic feedback.



ASSISTED BOIL (BOIL&COOK)

This function brings water to a boil and automatically adjusts the power to maintain the water in a gently boiling state, ready for adding your food. This function also helps you prevent over boiling and avoid wasting energy when compared to Booster mode. To save energy, we recommend covering the pot with a lid.





Assisted Boil is available only on cooking zones with the  icon.

NOTE: When using this function, the pot must be filled with water between 1/2 and 3/4 full. Do not add salt to the water before it has reached the boil, as this will prevent the system from working as expected.

For optimal performance, it is advisable to place the cookware in the centre of the cooking zone, to use water at room ambient temperature, and to activate the function when there is no 'residual heat' indicator present.

IMPORTANT: This function is meant to be used for boiling water only, not for milk or other types of liquid.

How to activate Assisted Boil:

1. Fill the pot with water (see the notes above).
2. Place the cookware on a cooking zone with the .
3. Select the Assisted Boil button .
4. Press the Assisted Boil button  one time if Heat Control is available on one cooking zone only. Press the button  multiple times if Heat Control is available on more than one cooking zones until you reach the cooking zone where you want to run the Assisted Boil function. A "-b-" indication will appear in the display to guide you through the zones.
5. When the zone is selected you will see -b- on the zone display blinking for a few seconds and then the function will start automatically.
6. When the Assisted Boil function starts, an animation will appear in the display during the heat-up phase.
7. The hob will provide an audible tone once the water has reached the boiling point and power will be automatically reduced to level 15.
8. Add your food and, if needed, change the power level to adjust the vigor of the boil to your preference. The power selection will be limited only to levels that are suitable for boil maintenance, so in a range of level 10 to 18.

NOTE:

- Depending on the Power Management setting or on the cooking zones activation sequence, Assisted Boil function might not be available. The hob will notify you with an acoustic feedback.
- When using this function, you will not be able to set a timer during the water heat up phase. Timer can be enabled only after receiving the audible notification that the water has reached the boil.
- The system is able to monitor the boiling process, but it is always recommended to stay present when the hob is in use.



REMOTE KEY

Function not currently available.

INDICATORS

HOT RESIDUAL HEAT

If "Hot" appears on the display, this means that the cooking zone is hot. The indicator lights up even if the zone has not been activated but has been heated due to the adjacent zones' use or because a hot pot has been placed on it. When the cooking zone has cooled down, the "Hot" disappears.



POT INCORRECTLY POSITIONED OR MISSING

This symbol appears if the pot is not suitable for induction cooking, is not positioned correctly or is not of an appropriate size for the cooking zone selected. If no pot is detected within 30 seconds of making the selection, the cooking zone switches off.

COOKING TABLE

The cooking table offers cooking tips for each power level. The actual power delivered for each power level depends on the cooking zone dimension and on the cookware used.

POWER LEVEL	COOKING TIPS
Maximum power (P)	Booster* - Bring the water to a boil as quickly as possible. Do not use with an empty pan or oil/butter.
17 – 18	Bring the water to a boil, deep fry** frozen products.
15 – 16	Maintain a lively boil, quick-sear, blister, stir-fry, brown.
10 – 14	Maintain a gentle boil, preheat, grill (for a long period of time), stir-fry, sauté, caramelize, brown, pancakes.
5 – 9	Simmer, Stew, Thicken, Slow Cook.
3 – 4	Keep warm, Defrost.
1 – 2	Melting, creaming (risotto).
Zero power (OFF)	Hob is in stand-by or off mode (possible end-of-cooking residual heat, indicated by “Hot”).

*Booster is a special mode with a higher power than level 18, that allows you to heat up water faster. This mode can be maintained for a maximum time of 10min depending on the zone used. After this time the power will be automatically reduced to level 18.

** For deep frying frozen products such as french fries, it is recommended to use non Flexi Zone cooking zones. If you want to deep-fry using Flexi Zone cooking zones, it is recommended to use the front one.

CLEANING AND MAINTENANCE



WARNING

- **Do not use steam cleaning equipment.**
- **Before cleaning, make sure the cooking zones are switched off and that the residual heat indicator (“H”) is not displayed.**

Important:

- Do not use abrasive sponges or scouring pads as they may damage the glass.
- After each use, clean the hob (when it is cool) to remove any deposits and stains from food residue.
- A surface that is not kept suitably clean may reduce the sensitivity of control panel buttons.
- Use a scraper only if residues are stuck to the hob. Follow the scraper manufacturer's instructions to avoid scratching the glass.
- Sugar or foods with a high sugar content can damage the hob and must be immediately removed.
- Salt, sugar and sand could scratch the glass surface.
- Use a soft cloth, absorbent kitchen paper or a special hob cleaner (follow the Manufacturer's instructions).
- Spills of liquid in the cooking zones can cause the pots to move or vibrate.
- After cleaning the hob, dry thoroughly.

If the CleanProtect logo is present on the glass, the hob has been treated with CleanProtect technology. This exclusive coating ensures excellent cleaning results and keeps the hob surface shiny for longer. Daily cleaning after each use is suggested.

To clean CleanProtect hobs, follow these recommendations:

- Soak the zones that need to be cleaned with water making sure to cover the entire stained area and being careful not to drop water on the control panel.
- For the water soaking:
 - In normal conditions, wait at least 2 minutes.
 - In heavy-dirt conditions, wait for at least 5 minutes.
 - If the water dries on the hob it is necessary to repeat the soaking step.
- Use a non-abrasive sponge to remove deposits and dry the hob after cleaning.

TROUBLESHOOTING

- Check that the electricity supply has not been shut off.
- If you cannot to turn the hob off after using it, disconnect it from the power supply.
- If alphanumeric codes appear on the display when the hob is switched on, consult the following table for instructions.

Please note: The presence of water, liquid spilled from pots or any objects resting on any of the hob buttons can accidentally activate or deactivate the control panel lock function.

DISPLAY CODE / ISSUE DETECTED	DESCRIPTION	POSSIBLE CAUSES	SOLUTION
F9E0	Wrong power cord connection.	The power supply connection is not exactly as indicated in "ELECTRICAL CONNECTION" paragraph.	Adjust the power supply connection according to "ELECTRICAL CONNECTION" paragraph.
F0EA	The control panel switches off because of excessively high temperatures.	The internal temperature of electronic parts is too high.	Wait for the hob to cool down before using it again.
F0E9 The power level is automatically decreased. A cooking zone turns OFF automatically. The hob turns OFF automatically..	The cooking zone turns off when the temperatures are too high. The power level is decreased, or the cooking zone turns off or the hob turns off when the temperatures are too high.	The internal temperature of electronic parts is too high. Ventilation of the hob may not be adequate to ensure proper functioning of the hob.	Wait until the cooking area has cooled off before using it again. To ensure proper operation of the appliance, the hob must have adequate ventilation through sufficient fresh air supply. Verify and ensure that the hob is installed respecting the indications described in the installation section. Ensure that no object is obstructing the rear and bottom-rear part of the hob.
F0E2, F0E4, F0E6, F0E8, F1E1, F2E1, F6E1, F6E2, F7E5, F7E6, FCE1, FCE2, FCE3	Disconnect the hob from the power. Wait a few seconds (more than 10) then reconnect the hob to the power supply. If the problem persists, call the service centre and specify the error code that appears on the display.		
d E [when the hob is off]	The hob does not heat up. The functions do not come on.	DEMO MODE on.	Follow the instructions in the "FIRST TIME USE" paragraph.
A special function does not turn on and the hob produces an acoustic feedback.	The hob does not allow a special function to be activated.	The power regulator limits the special function activation in accordance with the power management setting selected for the hob (e.g. 2.5 kW).	See paragraph "Power management".
When you choose a power level or use the Booster function, the power level automatically decreases.	The hob automatically sets the maximum available power level, even lower than the set one, to ensure that the cooking zone can be used.	The power regulator limits the special function activation in accordance with the power management setting selected for the hob (e.g. 2.5 kW). The Booster function can have a different duration depending on the zone used. After the Booster time has elapsed, the power will be automatically reduced to level 18. Ventilation of the hob may not be adequate to ensure proper functioning of the hob.	See paragraph "Power management" or "Booster function". To ensure proper operation of the appliance, the hob must have adequate ventilation through sufficient fresh air supply. Verify and ensure that the hob is installed respecting the indications described in the installation section. Ensure that no object is obstructing the rear and rear-lower part of the hob.
	Cookware is not detected. Cooking zone switches off after 30 seconds.	This symbol appears if the pot is not suitable for induction cooking, is not positioned correctly or is not of an appropriate size for the cooking zone selected. If no pot is detected within 30 seconds of making the selection, the cooking zone switches off.	If your cookware is suitable for induction cooking (see the Accessories section) and correctly positioned on the desired cooking zone, try using it on a smaller cooking zone. Otherwise, please use appropriate cookware (See the Accessories section).
The hob produces two short acoustic sounds and switches OFF by itself while showing the "OFF" message (for a maximum of 30 seconds without the chance to turn the hob on). Every 5 seconds the hob emits two short acoustic sounds.	Water spillage, food overflow and/or object positioned on the control panel buttons can mimic one's finger, which can accidentally activate or deactivate any of the hob buttons, including: <ul style="list-style-type: none"> • the ON/OFF button, causing the undesired turning off of the hob, • the key-lock button, causing the undesired activation of the key-lock function, if pressed continuously for more than 3 seconds. The function remains active even after the hob's switch off, with the Key-lock icon and LED on, • the scroll keypad, causing the undesired change of power levels. 		Dry and/or clean and/or remove the object. In case the key lock function has been accidentally activated press the Key-lock button for 3 seconds to turn off this function. Press the ON/OFF button to switch on the hob.
Water is not boiling while using HeatControl ()	Water is not boiling while having set the temperature using Heat Control function.	You are using Heat Control to boil water.	Use Assisted Boil (Boil & Cook) or booster function.
Click and/or tick-tack sound with a positioned cookware.	Such continuous click and/or tick-tack noise occurs when the used pan is not able to receive full power delivered for the level of power set. The diameter of the pan/pot might be lower than the minimum described in the user manual for specific cooking zones. Even if you use the pan/pot with the correct dimensions, some models of pan have a base partially covered by metal inserts (or without a uniform ferromagnetic distribution), and they do not always perform as expected.		Use a pan/pot with larger diameter than the minimum diameter described in the manual for the specific cooking zones, or use a more performing pot/pan (refer to accessories section).

The hob has been found turned off.	<p>The hob will automatically turn off in the following situations:</p> <ol style="list-style-type: none"> 1. In case of water spillage, food overflow, or objects positioned on the control panel buttons that could accidentally activate the ON/OFF button. If such a presence is not removed within 8 seconds, the hob will automatically switch off while producing a sound. 2. If there is no interaction with the control panel for longer than 30 seconds and no cooking zone is active. 3. If no cookware has been detected for longer than 30 seconds and there has been no interaction with the control panel for the same time. 4. The maximum working time for a power level or function had elapsed, and if there is no interaction with the hob for longer than 30 seconds, the appliance turns off automatically. 5. Other cases not specified here. 	See paragraph "Daily use" for further information. Manually turn on the hob.
------------------------------------	---	--

WI-FI FAQ

Not available yet

SOUNDS PRODUCED DURING OPERATION

Induction hobs may whistle or creak during normal operation.

These noises actually come from the cookware and are linked to the pan bottoms' characteristics (for example, when the bottoms are made from different layers of material or are irregular).

These noises may vary according to the type of cookware used and the amount of food it contains and not the symptom of something wrong.

Induction hobs may produce continuous click and/or tick-tack sounds with a positioned pot/pan. Such sounds may occur when the used pan is not able to receive full power delivered for the level of power set. Use a pan/pot with larger diameter than the minimum diameter described in the manual for the specific cooking zones, or use a more performing pot/pan (refer to accessories section).

Water spillage, food overflow and/or object positioned on the control panel buttons can mimic one's finger, which can accidentally activate or deactivate any of the hob buttons and can create one or more acoustic signals due to the contact of the objects on the buttons. If such presence is not removed within 8 seconds, the hob will automatically switch off while producing a sound. It will continue every 5 seconds until the object or water is removed from the control panel, even after the switch off. In order to avoid the switch off, in case of liquids spillage, dry thoroughly the user interface within 8 seconds from the water spillage or use the wipe function to have 30 seconds for cleaning and drying. Please consider that the ON/OFF button will be always active.

AFTER-SALES SERVICE

To receive complete assistance, please register your product on www.whirlpool.eu/register.

BEFORE CALLING THE AFTER-SALES SERVICE:

1. See if you can solve the problem by yourself with the help of the **TROUBLESHOOTING** suggestions.
2. Switch the appliance off and back on again to see if the fault persists.

IF AFTER THE ABOVE CHECKS THE FAULT STILL OCCURS, GET IN TOUCH WITH THE NEAREST AFTER-SALES SERVICE.

To receive assistance, call the number shown on the warranty booklet or follow the website's instructions on www.whirlpool.eu.

When contacting our Client After sales service, always specify:

- a brief description of the fault;
- the type and exact model of the appliance;

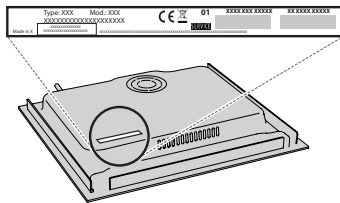

- the serial number (number after the word SN on the rating plate located under the appliance). The serial number is also indicated in the documentation;

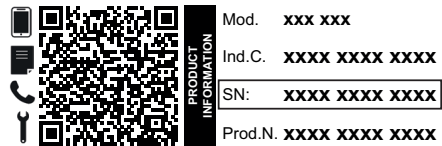

- your full address;
- your telephone number.

If any repairs are required, please contact an authorized after-sales service (to guarantee that original spare parts will be used and repairs carried out correctly).

Policies, standard documentation and additional product information can be found by:

- Using QR code in your appliance;
- Visiting our website docs.whirlpool.eu;
- Alternatively, **contact our After-sales Service** (See phone number in the warranty booklet). When contacting our After-sales Service, please state the codes provided on your product's identification plate.

