

Hotpoint

Refrigerator

User Manual

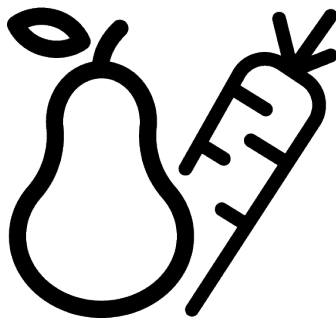

HPK 26411 XP4UK

11 5943 0502/ EN/ AC/ 13.03.26 08:52
7283548823

Please read this manual first!

Our valued customer,

Thank you for choosing product. We want you to get the best results from your product, which is manufactured with high quality and technology. To do this, please read this entire manual and the other documents provided carefully before using the product.

Follow all the information and warnings in the user manual. This will protect you and your product from potential hazards. Keep the user manual. If you give the product to someone else, include the user manual with it.

The following symbols appear in the user manual and on the product:



Read the user manual.



Hazard that may result in death or injury.

  SUPPLIER'S NAME MODEL IDENTIFIER → (*)  	<p>The model information as stored in the product data base can be reached by entering following website and searching for your model identifier (*) found on energy label.</p> <p>https://eprel.ec.europa.eu/</p>
--	--

Table of Contents

1	Safety Instructions	4
1.1	Important Safety Symbols	4
1.2	Intention of Use	4
1.3	Safety of Children, Vulnerable Persons and Pets	5
1.4	Electrical Safety	5
1.5	Handling Safety	6
1.6	Installation Safety.....	6
1.7	Operational Safety.....	9
1.8	Food Storage Safety.....	12
1.9	Maintenance and Cleaning Safety	13
1.10	Lighting	13
1.11	Disposal of the Old Product.....	13
2	Environmental Instructions	14
2.1	Compliance with the WEEE Dir- ective and Disposing of the Waste Product	14
3	Your Refrigerator	15
4	Installation	15
4.1	Right Place For Installation.....	15
4.2	Adjusting the Legs.....	16
4.3	Hot Surface Warning	16
5	Preparation	16
5.1	What To Do For Energy Saving	16
5.2	First Use	17
5.3	Climate Class and Definitions	17
6	Use of Your Appliance	18
6.1	Control Panel of the Product	18
6.2	Storing Food in Your Product	20
6.3	Crisper	24
6.4	Crisper Technologies	24
6.5	Dairy Products Cold Storage Area	24
6.6	Reversing the Door Opening Side.	24
6.7	Door Open Alert	24
6.8	Replacing the Illumination Lamp..	25
7	Maintenance and Cleaning	25
8	Troubleshooting	26

1 Safety Instructions

- This section includes the safety instructions necessary to prevent the risk of personal injury or material damage.
- Our company shall not be held responsible for damages that may occur if these instructions are not observed.
- Always have installation and repair operations performed by manufacturer, authorized service or a person who will be described by importer company.
- Use original spare parts and accessories only.
- Do not repair or replace any component of the product unless it is clearly specified in the user manual.
- Do not perform any modifications on the product.

1.1 Important Safety Symbols

-  Risk of electric shock!
-  Read the user manual.
-  Danger that may result in burns due to contact with hot surfaces.
-  Combustible material, warning against fire hazard.
-  Risk of injury due to contact with sharp surfaces!

 Risk of UV-C radiation

1.2 Intention of Use

- This product is not suitable for commercial use and should not be used for a purpose other than its intended use.
- This product is intended for operating interiors, such as households or similar.

For example;

In the staff kitchens of the stores, offices and other working environments,

In farm houses,

In the units of hotels, motels or other resting facilities that are used by the customers,

In hostels, or similar environments,

In catering services and similar non-retail applications.

- This product shall not be used in open or enclosed external environments such as vessels, camper vans, balconies or terraces. Exposing the product to rain, snow, sunlight and wind may cause risk of fire.

1.3 Safety of Children, Vulnerable Persons and Pets

- This product may be used by children aged 8 years and older and persons with under-developed physical, sensory or mental capabilities or lack of experience and knowledge if they are being supervised or have been given instruction concerning use of the appliance in a safe way and the hazards involved.
- Children between 3 and 8 years are allowed to put and take out food into/from the cooler product.
- Children and pets must not play with, climb on, or get inside the product.
- Children and pets must be kept away from the cabin area (compressor) where electrical parts are located.
- Cleaning and user maintenance must not be performed by children unless there is someone overseeing them.
- Keep the packaging materials away from children. Risk of injury and suffocation.
- If there is a lock available on the product's door, keep the key out of children's reach.

1.4 Electrical Safety

- The product shall not be plugged into the outlet during installation, maintenance, cleaning, repair, and transportation operations.
- If the power cable is damaged, it must be replaced by the person sent by the manufacturer, authorized service provider or the importer to prevent any potential danger.
- Do not tuck the power cable under the product or to the rear of the product. Do not put heavy items on the power cable. The power cable should not be bent, crushed, and come into contact with any heat source.
- Use an original cable only. Do not use cut or damaged cables.
- Do not use an extension cord, multi-plug or adaptor to operate your product.
- Portable multi-plugs or portable power supplies may overheat and cause fire. Thus, do not have a multi-plug, portable power sources behind or in the vicinity of the product.

- Before plugging the product into the power source, please remove the power cable from the condenser hook (if available) during the installation.
- The user should not be able to reach the electrical parts after installation.
- Do not plug the product's power cord in a loose or damaged power outlet. These types of connections may overheat and cause fire.
- The plug shall be easily accessible. If this is not possible, a mechanism that meets the electrical legislation and that disconnects all terminals from the mains (fuse, switch, main switch, etc.) shall be available on the electrical installation.
- The product must not be operated with an external switching device such as a timer, or a remote controlled system.
- Do not use the product when your feet are bare or your body is wet.
- Do not touch the plug with wet hands.
- When unplugging the appliance, don't hold the power cable, but the plug.
- Make sure that the plug is not wet, dirty or dusty.

- Do not ever connect your product to power saving devices. These systems are harmful for the product.

1.5 Handling Safety

- Make sure to unplug the appliance before carrying the product.
- This product is heavy, do not handle it by yourself. Injuries may occur if the product falls on you. Do not bump into places or drop the product while transporting it.
- Always close the doors and do not hold the product by its doors while transporting it.
- Be careful not to damage the cooling system and the pipes while handling the product. Do not operate the product if the pipes are damaged, and contact an authorized service.

1.6 Installation Safety

- To prepare the product for use, see the information in the user and installation manual and make sure the electric and water utilities are as required. If not, call a qualified electrician and plumber to arrange the utilities as necessary.
- **Failure to do so may result in electric shock, fire, problems with the product, or injury.**

- Before starting the installation, switch off the fuse to de-energise the power line to which the product is connected.
- The product should be installed by two or more people. Use protective gloves while removing the product from the packaging and installation.
- This product is designed for use at a maximum altitude of 2000 metres above sea level.
- Keep children away from installation area.
- Check for any damage on the product before installing it. Do not have the product installed if it is damaged.
- Always use personal protective equipment (gloves, etc.) during product installation, maintenance and repair. Risk of injury.
- Do not install or leave the product in places where it may be exposed to external ambient temperatures.
- Place the product on a clean, level and hard surface and balance it with the adjustable legs (by rotating the front feet to the right or left). Otherwise, the refrigerator may tip over and cause injuries.
- Proceed with care to prevent causing any damage to the floors (tiling etc.) while moving the product. Install the product on a floor, or provide sufficient support depending on the size, weight and the use-case of the product. Ensure that the product is not near a heat source, and all four feet are stable and leaning against the floor. Install the product as necessary, and ensure that it is horizontal, using a bubble level. To ensure the complete efficiency of the refrigerant circuit, wait for at least two hours before operating the product.
- The product shall be installed in a dry and ventilated environment. Do not keep carpets, rugs or similar covers under the product. This may cause risk of fire as a result of inadequate ventilation!
- Do not block or cover ventilation holes. Otherwise, power consumption increases and your product may be damaged.
- Leave sufficient space by the sides and above to ensure adequate ventilation. The gap between the back panel and the wall behind the product must be a minimum of 50mm in order to prevent hot surfaces. Reducing this distance may increase the energy consumption of product.

- When placing the product, make sure that the supply cable is not damaged or pinched.
- The product must not be connected to supply systems and power sources which may cause sudden voltage changes (i.e. a portable solar-energy power source). Otherwise, damage to your product may occur as a result of the abrupt voltage fluctuations!
- The more refrigerant a refrigerator contains, the bigger its installation room shall be. In very small rooms, a flammable gas-air mixture may occur in case of a gas leak in the cooling system. At least 1 m³ of volume is required for each 8 grams of refrigerant. The amount of the refrigerant available in your product is specified in the Type Label.
- The product must never be placed in such a way that power cables, the metal hose of the gas stove, metal gas or water pipes come into contact with the product's rear wall (or the condenser).
- The installation place of the product must not be exposed to direct sunlight and it shall not be in the vicinity of a heat source such as stoves, radiators, etc. If you cannot prevent installation of the product in the vicinity of a heat source, use a suitable insulation plate and make sure the minimum distance to the heat source is as specified below:
 - At least 30 cm away from heat sources such as stoves, ovens, heating units and heaters, etc.,
 - And at least 5 cm away from electrical ovens.
- Your product has the protection class of I.
- Plug the product in a grounded socket that conforms with the Voltage, Current and Frequency values specified in the type label. The socket must have a 10A – 16A fuse. Our firm will not assume responsibility for any damages due to usage without earthing and without power connection in compliance with local and national regulations.
- The product's power cable must be unplugged during installation. Otherwise, risk of electric shock and injury may occur!
- Do not plug the product to loose, broken, dirty, greasy sockets or sockets that have come out of their seats or sockets with a risk of water

contact. These types of connections may overheat and cause fire.

- Place the power cable and hoses (if any) of the product so that they shall not cause a risk of tripping over.
- Penetration of humidity and liquid to live parts or to the power cord may cause short circuit. Thus, do not use the product in humid environments or in areas where water may splash (e.g. garage, laundry room, etc.) If the refrigerator is wet by water, unplug it and contact an authorized service.
- Do not ever connect your refrigerator to power saving devices. These systems are harmful for the product.
- There is a risk of contact with electrical parts when removing the electronic board cover and the compressor rear cover (if fitted). Do not remove the electronic board cover and the compressor rear cover (if fitted). There is a risk of electrocution!
- In case of a failure of the product, unplug it (or de-energise the fuse to which it is connected), and do not operate until it is repaired by the authorized service. There is a risk of electric shock!
- Do not place flames (lighted candle, cigarette, etc.) or heat sources (iron, hob, oven, etc.) on or near the product. Do not place flammable/explosive materials near the product...
- Do not get on the product. Risk of falling and injury!
- Do not cause damage to the pipes of the cooling system using sharp and piercing tools. The refrigerant that sprays out in case of puncturing the gas pipes, pipe extensions or upper surface coatings may cause irritation of skin and injury to the eyes.
- Do not intervene in or damage the coolant circuit Risk of explosion.
- Do not place and operate electrical appliances inside the refrigerator/freezer unless it is advised by the manufacturer.
- Do not use any procedures other than those recommended by the manufacturer to speed up defrosting.

1.7 Operational Safety

- Do not ever use chemical solvents on the product. These materials contain an explosion risk.

- Take due care not to jam any parts of your hands or your body to the moving parts inside the product. Be careful to prevent jamming of your fingers between the refrigerator and its door. Be careful while opening or closing the door if there are children around.
- Do not put ice cream, ice cubes or frozen food to your mouth as soon as you take them out of the freezer. Risk of frostbite!
- Do not touch the inner walls, metal parts of the freezer or food kept inside the freezer with wet hands. Risk of frostbite!
- Do not place soda cans or cans and bottles that contain fluids that may be frozen to the freezer compartment. Cans or bottles may explode. Risk of injury and material damage!
- Do not use or place materials sensitive against temperature such as flammable sprays, flammable objects, dry ice or other chemical agents in the vicinity of the refrigerator. Risk of fire and explosion!
- Do not store explosive materials such as aerosol cans with flammable materials inside the product.
- Do not place cans containing fluids over the product an open state. Splashing of water on an electrical part may cause an electric shock or a fire.
- Due to risk of breaking, do not store glass containers with liquid inside in the freezer compartment.
- This product is not intended for storage and cooling of medicines, blood plasma, laboratory preparations or similar materials and products that are subject to the Medical Products Directive.
- If the product is used against its intended purpose, it may cause damage to or deterioration of the products stored inside.
- If your refrigerator is equipped with blue light, do not look at this light with optical devices. Do not stare directly at UV LED light for a long time. Ultraviolet rays may cause eye strain.
- Do not fill the product with more contents than its capacity. Do not use any procedures other than those recommended by the manufacturer to speed up defrosting. Injuries or damages may occur if the contents of the refrigerator fall when the door is opened. Sim-

ilar problems may also occur when an object is placed over the product.

- Ensure that you have removed any ice or water that may have fallen to the floor to prevent injuries.
- Change the locations of the racks/bottle racks on the door of your refrigerator only when the racks are empty. Danger of injury!
- Do not place objects that may fall/tip over on the product. These objects may fall while opening or closing the door and cause injuries and/or material damages.
- Do not hit or exert excessive pressure on glass surfaces. Broken glass may cause injuries and/or material damages.
- For products designed to use an air filter inside an accessible fan cover, the filter must always be in position when the refrigerator is in function.
- Do not block out the fan (if available) with food.
- Damaged gaskets should be replaced as soon as possible.
- Your product may have special compartments (Fresh Food Compartment, Zero Degrees Compartment etc.) Unless otherwise stated in the relevant manual of the product, these

compartments can be removed, and the product can be used with the same performance.

- The cooling system in your product contains R600a refrigerant. The refrigerant type used in the product is specified in the type label. This gas is flammable. Therefore, be careful not to damage the cooling system and the pipes while operating the product. In case of damage to the pipes;
 1. Do not touch the product or the power cable.
 2. Keep the product away from potential sources of fire that may cause the product to catch fire.
 3. Ventilate the area where the product is placed. Do not use a fan.
 4. Contact Authorized Service.Before disposing of old products that shall not be used any more:
 1. Unplug the power cord from the mains socket.
 2. Cut the power cable and remove it from the appliance together with the plug.
 3. Do not remove the racks and drawers from the product to prevent children from getting inside the appliance.
 4. Remove the doors.

5. Store the product so that it shall not be tipped over.
 6. Do not allow children to play with the scrapped product.
 7. If the product is damaged and you observe gas leak, please stay away from the gas. Gas may cause frostbite if it contacts your skin.
- Do not dispose of the product by throwing it into fire. Risk of explosion.
 - If there is a lock available on the product's door, keep the key out of children's reach.

1.8 Food Storage Safety

Please pay attention to the following warnings to avoid food spoilage:

- Leaving the doors open for a long time may cause the temperature inside the product to rise.
- Regularly clean the accessible drainage systems in contact with food.
- Clean the water tanks that have not been used for 48 hours and mains-fed water systems that have not been used for more than 5 days.
- Store raw meat and fish products in appropriate compartments within the product.

Thus, it does not drip on or come into contact with other foods.

- Two-star freezer compartments are used for storing pre-filled foods, making and storing ice and ice cream.
- One, two and three-star compartments are not appropriate for freezing fresh food.
- If the cooling product has been left empty for a long time, turn off the product, defrost, clean, and dry the product in order to protect the housing of the product.
- After the foods are placed, check if the compartment hatches, and especially the freezer door, are properly closed.
- Use the refrigerator compartment for storing fresh foods, and the freezer compartment for storing frozen goods, freezing fresh foods and preparing ice cubes.
- Do not store foods without properly sealing them in the refrigerator and the freezer compartments, to prevent direct contact with the inner surfaces.

1.9 Maintenance and Cleaning Safety

- Unplug the refrigerator or de-energise the fuse before cleaning it or starting to perform maintenance.
- Do not pull by the door or door handle if you are going to move the product for cleaning purposes. The door may cause injuries if the handle is pulled too hard.
- Do not place hands, feet or metal objects under or behind your product. Jamming may occur or any sharp edge may cause personal injuries.
- Do not wash the inside or outside of the product with a pressure washer, steam, spray water or pouring water. Risk of electric shock and fire.
- When cleaning the product, do not use sharp and abrasive tools or household cleaning agents, detergent, gas, gasoline, thinner, alcohol, varnish, and similar substances. Use only cleaning and maintenance agents that are not harmful for food inside the product.
- Do not use paper towels, kitchen sponges or other hard cleaning materials.
- Do not ever use steam or steamed cleaning materials for cleaning the product and thaw-

ing the ice inside it. Steam contacts the live areas in your refrigerator and causes short circuit or electric shock.

- Do not use any mechanical tools or any other tools than the recommendations of the manufacturer to speed up the thawing operation.
- Take care to keep water away from the ventilation holes, electronic circuits or lighting of the product. Otherwise, risk of fire or electric shock may occur.
- Use a clean, dry cloth to wipe the dust or foreign material on the tips of the plugs. Do not use a wet or damp piece of cloth to clean the plug. Otherwise, risk of fire or electric shock may occur.

1.10 Lighting

Contact an authorized service when you shall replace the LED / bulb using for lighting.

1.11 Disposal of the Old Product

When disposing of your old product follow the instructions below:

- To prevent children from accidentally locking themselves into the product, if there is door lock, disable it.

- Splash of coolant is harmful to the eyes. Do not damage any part of the cooling system while disposing of the product.
- It may be fatal if the compressor oil is swallowed or if it penetrates the respiratory tract.
- Cooling system of your product includes R600a gas as specified in the type label. This

gas is flammable. Do not dispose of the product by throwing it into fire. Risk of explosion!

- C-Pentane is used as a blowing agent in insulation foam and it is a flammable substance. Do not dispose of the product by throwing it into fire.

2 Environmental Instructions

2.1 Compliance with the WEEE Directive and Disposing of the Waste Product



This product complies with EU WEEE Directive (2012/19/EU). This product bears a classification symbol for waste electrical and electronic equipment (WEEE).

This symbol indicates that this product shall not be disposed with other household wastes at the end of its service life. Used device must be returned to official collection point for recycling of electrical and electronic devices. To find these collection systems please contact to your local authorities or retailer where the product was purchased. Each household performs important role in recovering and recycling of old appliance. Appropriate disposal of used appliance helps prevent potential negative consequences for the environment and human health.

Compliance with RoHS Directive

The product you have purchased complies with EU RoHS Directive (2011/65/EU). It does not contain harmful and prohibited materials specified in the Directive.



Package information

Packaging materials of the product are manufactured from recyclable materials in accordance with our National Environment Regulations. Do not dispose of the packaging materials together with the domestic or other wastes. Take them to the packaging material collection points designated by the local authorities.



Conformity with standards and test information / Declaration of EC conformity

Development, manufacture and sales stages of this product conform to the safety rules in all relevant guidelines of the European Community. 2014/35/EU, 2014/30/EU, 93/68/EC, IEC 60436/DIN 44990, EN 50242

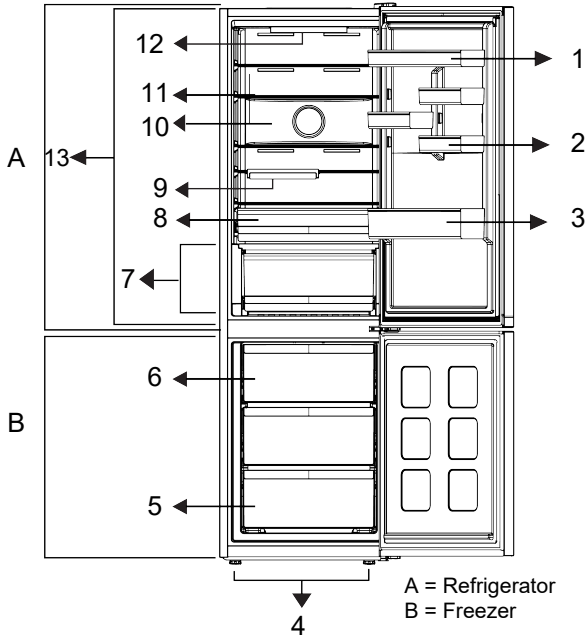

- | | |
|----------------------------|----------------------|
| 1 Adjustable Door Shelf | 2 *Egg Rack |
| 3 * Bottle Rack | 4 * Adjustable Legs |
| 5 * Freezer Compartment | 6 * Ice Cube |
| 7 * Vegetable Drawer | 8 * Vegetable Drawer |
| 9 *Foldable Bottle Rack | 10 *Fan |
| 11 *Adjustable Trunk Shelf | 12 *Lighting Lamp |
| 13 *Fresh Food | |

***Optional** The figures in this user manual are schematic and may not be exactly compatible with your product. If the product you purchased does not contain the relevant parts, they are valid for other models.

4 Installation

Read the "Safety Instructions" first!

4.1 Right Place For Installation

Contact the Authorized Service for the product's installation. To prepare the product for installation, see the information

in the user manual and make sure the electric and water utilities are as required. If not, call an electrician and plumber to arrange the utilities as necessary.

- Place the product on a flat surface to avoid vibration

- Place the product at least 30 cm away from the heater, stove and similar sources of heat and at least 5 cm away from electric ovens.
- When placing two coolers in adjacent position, leave at least 4 cm distance between the two units.
- Keep the product out of direct sunlight and in a dry place.
- Products need to have at least 5cm clearance between side walls and rear wall to reach the declared performance values. If clearance is less than 5cm, energy and performance losses will be at a level that will not affect to end user.

4.2 Adjusting the Legs

If the product is not in balanced position, adjust the front adjustable legs by rotating them to right or left.

5 Preparation

Read the "Safety Instructions" first!

5.1 What To Do For Energy Saving

- This refrigerating appliance is not intended to be used as a built in appliance.
- When loading the food, leave enough space inside the refrigerator to allow sufficient air circulation for cooling.
- Since hot and humid air will not directly penetrate into your product when the doors are not opened, your product will optimize itself in conditions sufficient to protect your food. Under these circumstances, functions and components such as compressor, fan, heater, defrost, lighting, display and so on will operate according to the needs by consuming minimum energy.
- In case that multiple options are present, glass shelves must be placed so that the air outlets at the rear wall are not blocked and preferably, in a way that air outlets remain below the glass shelf. This combination may help improving air distribution and energy efficiency.
- Using the below drawer when storing is strongly recommended.
- For optimum performance, Quick Freezing can be used (if available), 24 hours prior to placing fresh foods in the freezer.
- In most cases, 24 hours is enough for the Quick Freezing function after fresh foods are placed in the freezer. After some time, Quick Freezing function will deactivate automatically.
- When freezing a small amount of food, Quick Freezing function can be deactivated after some time to ensure energy saving.
- Depending on the product's features; defrosting frozen foods in the cooler compartment will ensure energy saving and preserve food quality.
- In order to load the maximum quantity of food into the freezer compartment of your refrigerator, the upper drawers should be taken out and the food should be placed onto the wire/glass shelves.
- Place the food as shown below, keeping a distance from the cooler compartment temperature sensor. If they are in contact with the sensor, energy consumption of the appliance might increase.

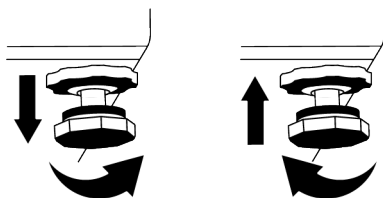

4.3 Hot Surface Warning

The side walls of your product are equipped with cooler pipes to enhance the cooling system. High pressure fluid may flow through these surfaces, and cause hot surfaces on the side walls. This is normal and it does not require servicing.

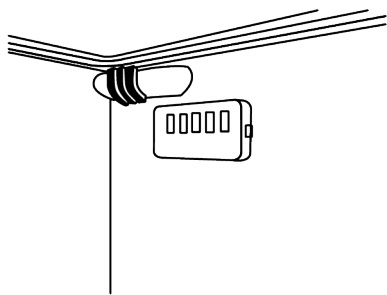

- Store food in the cooler or chill compartment according to proper storage conditions to save energy.
- Food packages shall not be in direct contact with the temperature sensor located in the freezer compartment.

5.2 First Use

Before using your product make sure the necessary preparations are made in line with the instructions in "Safety Instructions" and "Installation" sections.

- Wait for at least 2 hours before operating the product, to ensure the complete efficiency of refrigeration.
- Keep the product running without placing any food inside for 6 hours and the product door should be kept as closed as possible.
- The temperature change caused by opening and closing of the door while using the product may normally lead to condensation on door/body shelves and glassware placed in the product.

- A sound will be heard when the compressor is engaged. It is normal for the product to make noise even if the compressor is not running, as fluid and gas may be compressed in the cooling system.
- It is normal for the front edges of the product to be warm. These areas are designed to warm up in order to prevent condensation
- For some models, indicator panel turns off automatically 1 minute after the door closes. It will be reactivated when the door is opened or any button is pressed.

5.3 Climate Class and Definitions

Please refer to the Climate Class on the rating plate of your device. One of the following information is applicable to your device according to the Climate Class.

- **SN:** Long Term Temperate Climate: This cooling device is designed for use at ambient temperatures between 10 °C and 32 °C.
- **N:** Temperate Climate: This cooling device is designed for use at ambient temperatures between 16°C and 32 °C.
- **ST:** Subtropical Climate: This cooling device is designed for use at ambient temperatures between 16°C and 38°C.
- **T:** Tropical Climate: This cooling device is designed for use at ambient temperatures between 16°C and 43°C.

6.1 Control Panel of the Product

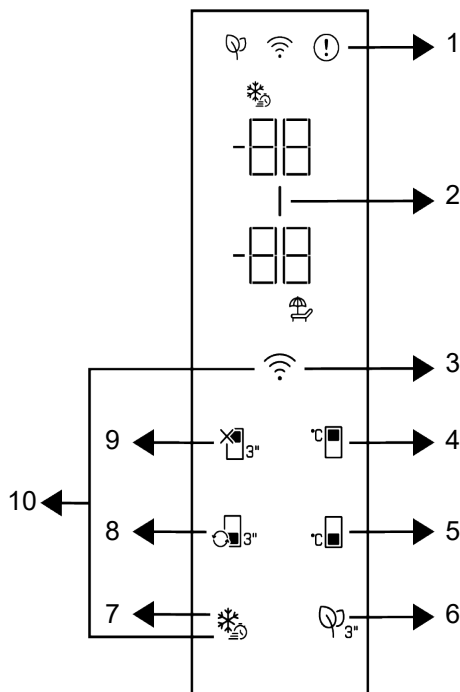

1 * Error Status Indicator

3 *Wireless Key

5 * Freezer Compartment Temperature Setting Key

7 * Quick Freezing Key

9 * Cooler Compartment OFF (Vacation) Function

2 * Energy Saving (Display Off) Indicator

4 * Cooler Compartment Temperature Setting Key

6 * Deodoriser Module Key

8 *Compartment Conversion Key

10 *Key for Resetting Wireless Connection Settings

Read the "Safety Instructions" first!

Auditory and visual functions on the indicator panel will assist you when using the product.

***Optional:** Shown functions are optional, there may be differences of shape and location in functions found on your appliance's indicator panel.

1. Error Condition Indicator

This indicator shall be active when your refrigerator cannot perform adequate cooling or in case of any sensor error. "E" will be displayed on the freezer compartment temperature indicator and figures such as 1,2,3... will be displayed on the cooler compartment temperature indicator. These fig-

ures on the indicator provide information to the authorized service about the error that has occurred. Exclamation mark may be displayed when you load warm food to the freezer compartment or keep the door open for a long period of time. This is not a fault, this warning shall be removed when the food is cooled down or when any key is pressed.

2. Energy Saving (Display Off) Indicator

Energy saving function is enabled automatically and the energy saving symbol lights up when the door of the product is not opened or closed for some period of time. When the energy saving function is active, all symbols on the display except the energy saving symbol shall be turned off. When the energy saving function is active, pressing any key or opening the door will deactivate the energy saving function and the display signals will return to normal. The energy saving function is a function activated ex-factory and cannot be cancelled.

3.*Wireless Key

This key is utilized to connect wirelessly to your appliance through HomeWhiz mobile application. If the key is pressed for a long time (3 seconds), the wireless connection symbol on the display/indicator will blink slowly (in 0.5 second intervals). The home network is initialized on the product this way. After achieving wireless connection with the product, wireless connection symbol illuminates continuously. You may activate/deactivate the connection after the first setting is completed by pressing this key. The wireless connection symbol will flash quickly (at 0.2 second intervals) until the connection is established. When the connection becomes active, wireless connection symbol flashes continuously. If the connection cannot be established for a long period, check your connection settings and refer to the "Troubleshooting" section provided in the user manual. Use HomeWhiz application for wireless connection. The installation steps are described on the application during installation. You may ac-

cess the application by reading the QR code available on the HomeWhiz label on the product. The application can be obtained from App Store for IOS devices or from Play Store for Android devices. For details visit <https://www.homewhiz.com/> address.

4. Cooler Compartment Temperature

Setting Key

Allows setting of temperature for cooler compartment. Pressing the key will enable the cooler compartment temperature to be set at 8 °C, 7 °C, 6 °C, 5 °C, 4 °C, 3 °C, 2 °C, and 1 °C.

5.Freezer Compartment Temperature

Setting Key

Temperature setting is made for freezer compartment. Pressing the key will enable the freezer compartment temperature to be set at -18 °C, 19°C, -20 °C, -21 °C, -22 °C, -23 °C, and -24 °C.

6.*Deodoriser Module Key

Press this key for 3 seconds to activate/deactivate the deodoriser feature. When the deodoriser feature is active, the deodoriser module icon is illuminated. When the feature is active, the deodoriser module will be operated periodically.

7.*Quick Freezing Key

When the quick freezing key is pressed the quick freezing symbol shall be illuminated and the quick freezing function shall be activated. The freezer compartment temperature is set to -27 °C. Press the key again to cancel the function. The quick freezing function will be cancelled automatically. To freeze a large amount of fresh food, press the quick freezing key before placing the food in the freezer compartment.

8.*Compartment Conversion Key

When the compartment conversion key is pressed for 3 seconds, the freezer compartment switches between cooler, off and freezer modes, respectively. When it is operated as cooler compartment, the com-

partment temperature is set as 4 °C. In OFF mode, compartment temperature indicator shall display "--".

9.*Cooler Compartment Off (Vacation)

Function Key 3"

Press the key for 3 seconds to activate the vacation function. Vacation mode is activated and the vacation symbol is illuminated. "--" expression is displayed on the cooler compartment temperature indicator and the cooler compartment does not perform active cooling operation. It is not suitable to keep your food in the cooler compartment when this function is activated. The other compartments continue to cool according to temperatures set before. Press the key for 3 seconds again to cancel this function.

10.*Key for Resetting Wireless Connection Settings +

To reset wireless connection settings, Quick freezing and Wireless connection keys should be pressed simultaneously for 3 seconds. All user information recorded previously are removed on the product where wireless connection settings are reset/restored to factory defaults.

Temperature settings can be set between 1-8 °C for the refrigerator compartment and between -24 and -18 °C for the freezer compartment. Adjustable temperature values may vary within these ranges depending on product specifications.

6.2 Storing Food in Your Product

Food Storage in Refrigerators and Cold Compartments

- Frequent opening and closing of the compartment door, or leaving it open for extended periods, can cause compartment temperatures to rise significantly, reducing food shelf life and leading to spoilage.
- To prevent changes in smell and taste, food should be stored in airtight containers.

- To achieve better and more even cooling, place the food items far apart so that cold air can circulate between them.
- Allow for airflow by leaving a gap between the food and the inside wall. If you place the food against the back wall, it may freeze.
- Allow cooked, hot food to cool to room temperature before refrigerating. Then, you can place the lukewarm food on the lower shelves of your refrigerator. Keep lukewarm food away from perishable foods.
- Pay particular attention to ensuring that frozen foods are not mixed with fresh foods.
- Thaw your frozen foods in the refrigerator compartment. This way, you can use the frozen food to cool the compartment, saving energy.
- Storing unripe tropical fruits (mangoes, various types of melons, papayas, bananas, pineapples) in the refrigerator can accelerate the ripening process. This means a shorter storage time, so it is not recommended.
- Onions, garlic, ginger, and other root vegetables should be stored in a dark, cool room, not in the refrigerator.
- If you notice that food in your refrigerator has spoiled, discard it and clean any accessories that came into contact with it.
- To quickly cool down large pot dishes like soups and stews, you can divide them into shallow containers and store them in the refrigerator.
- Keep unpackaged foods away from eggs.
- Keep fruits and vegetables separate and store all types together (for example, apples with apples, carrots with carrots).
- Remove the greens from the plastic bag, wrap them in paper towels or a dishcloth, and place them in the refrigerator. If you wash these types of foods before putting them in the refrigerator, remember to dry them.

- You can create a moist environment while allowing air circulation by storing fruits and vegetables that are prone to drying out in perforated or open-mouthed plastic bags.
- Except in cases of extreme environmental conditions, food in all compartments will stay fresh longer if your product is set to the set values indicated in the recommended set value table.
- Do not store cold-sensitive vegetables such as leafy greens, tomatoes, and cucumbers in the cold compartment. If the

cold compartment must be used to store vegetables, ensure that your refrigerator's control panel is set to 5°C or warmer.

Food Storage in the Cold Compartment

In the cold compartment, the temperature of the food being stored can vary between +3°C and -3°C. Temperatures may drop below 0°C in the cold compartment, therefore it is not suitable for storing fresh fruits/vegetables. If you need to store fresh food in the cold compartment, make sure you set the refrigerator setting to 5°C or warmer.

Store foods in different places according to their characteristics:	
Food	Location
Egg	Door shelf
Dairy products (butter, cheese)	If available, a zero-degree (breakfast) compartment/cold compartment
Fruits, vegetables and greens	Fruit and vegetable compartment, vegetable drawer or; In the fresh food compartment, provided your refrigerator is set at a temperature above 5°C, in the vegetable drawer or in the Everfresh+ drawer (if available).
Fresh meat, poultry, fish, sausage products, cooked foods.	If available, a zero-degree (breakfast) compartment/cold compartment
Ready-to-eat foods, packaged products, canned goods, and pickles.	Top shelves or door shelf
Beverages, bottles, condiments, and snacks.	Door shelf

Storing Food in the Freezer Compartment

- You can achieve faster cooling by activating the Quick Freeze function 4-6 hours before freezing.
- Allow hot food to reach room temperature before placing it in the freezer compartment.
- Foods to be frozen should be divided into portions large enough for each serving and frozen in separate packages.
- It is recommended to package food before placing it in the freezer.
- To prevent food from going past its expiration date, write the freezing date, storage time, and the name of the food on the package, according to the storage times of different foods.
- Consume thawed food quickly. Thawed food cannot be refrozen unless cooked. It is not safe to consume thawed and refrozen fresh food without cooking it.

- When freezing fresh food, avoid contact between fresh and already frozen foods. Otherwise, the frozen foods will thaw.

Storing Frozen Foods

- When storing food, please follow the storage times specified in these instructions.
- To preserve food quality, try to keep the time between purchase and storage as short as possible.
- Buy frozen foods that are stored at -18°C or lower.
- Avoid buying foods that have ice or similar substances in their packaging. This means the product may have partially thawed and then refrozen. Temperature affects the quality of the food.
- Store food for the time recommended by the manufacturer. Only remove as much food from the freezer as you need.

- Except in extreme environmental conditions, if your product is set to the set values specified in the recommended set value table, food will stay fresh longer in both the fresh food compartment and the freezer compartment.
- Fresh fruits and vegetables may partially freeze if the fresh food compartment is set to a lower temperature.
- The 2-star compartment is suitable for pre-frozen food. Ice cream and ice cubes can be stored there.
- Freeze food only in the 4-star compartment.

Meat and Fish		Preparation Method	Longest storage period (month)	
Meat Products	Veal	Steak	Cut into 2 cm thick pieces and place foil between them or wrap tightly with plastic wrap.	6-8
		Roast	By packaging the meat pieces in a freezer bag or wrapping them tightly with plastic wrap.	6-8
		Flaked	In small pieces	6-8
		Schnitzel, chops	By placing foil between the sliced pieces or wrapping them individually in plastic wrap.	6-8
	Mutton	Chop	By placing foil between the pieces of meat or wrapping them individually with plastic wrap.	4-8
		Roast	By packaging the meat pieces in a freezer bag or wrapping them tightly with plastic wrap.	4-8
		Flaked	By packaging the chopped meat in a freezer bag or wrapping it tightly with plastic wrap.	4-8
	Beef	Roast	By packaging the meat pieces in a freezer bag or wrapping them tightly with plastic wrap.	8-12
		Steak	Cut into 2 cm thick pieces and place foil between them or wrap tightly with plastic wrap.	8-12
		Flaked	In small pieces	8-12
		Boiled meat	By packaging it in small portions using freezer bags.	8-12
	Mince	Unseasoned, in flat packages.	1-3	
	Offal (parts)	In pieces	1-3	
	Sausage - Salami	Even if it's in a casing, it must be packaged.	1-3	
	Ham	By placing foil between the sliced pieces.	2-3	
Poultry and game animals	Chicken and Turkey	Wrapped in foil	4-6	
	Goose	Wrap in foil (portions should not exceed 2.5 kg)	4-6	
	Duck	Wrap in foil (portions should not exceed 2.5 kg)	4-6	
	Deer, Rabbit, Roe Deer	Wrap in foil (portions should not exceed 2.5 kg, and the bones should be removed).	6-8	
Fish and sea-food	Freshwater fish (Trout, Carp, Pike, Catfish)	After thoroughly cleaning the insides and scales, it should be washed and dried, and the tail and head should be cut off if necessary.	2	
	Lean fish (Sea bass, Turbot, Sole)		4-6	
	Oily fish (Bonito, Mackerel, Bluefish, Red Mullet, Anchovy)		2-4	
	shellfish		Cleaned and in bags.	4-6
	Caviar		In its packaging, in an aluminum or plastic container.	2-3

"The storage times indicated in the table are based on a storage temperature of -18°C."

Vegetables and Fruits	Preparation Method	Longest storage period (month)
Ayşekadin and Pole Beans	After washing and cutting into small pieces, blanch for 3 minutes.	10-13
Pea	After cleaning and washing, blanch for 2 minutes.	10-12
Cabbage	After cleaning, blanch for 1-2 minutes.	6-8
Carrot	After cleaning and slicing, blanch for 3-4 minutes.	12
Pepper	After cutting off the stem, splitting it in half and removing the seeds, blanch it for 2-3 minutes.	8-10
Spinach	After washing and cleaning, blanch for 2 minutes.	6-9
Leek	After chopping, blanch for 5 minutes.	6-8
Cauliflower	Separate the leaves, cut the center into pieces, and then blanch it in a little lemon water for 3-5 minutes.	10-12
Aubergine	After washing, cut into 2cm pieces and blanch for 4 minutes.	10-12
Courgette	After washing, cut into 2cm pieces and blanch for 2-3 minutes.	8-10
Mushroom	Lightly sauté in oil and squeeze lemon over it.	2-3
Sweetcorn	After cleaning, package them with the cob or in individual pieces.	12
Apples and Pears	Peel the skin, slice it, and blanch it for 2-3 minutes.	8-10
Apricots and peaches	Cut it in half and remove the seeds.	4-6
Strawberries and Raspberries	By washing and sorting	8-12
cooked fruit	By adding 10% sugar to the container	12
Plum, Cherry, Sour Cherry	After washing and removing the stems	8-12

"The storage times indicated in the table are based on a storage temperature of -18°C."

Dairy products	Preparation Method	Longest Storage Period (Months)	Storage Conditions
Cheese (excluding feta cheese)	In slices, with foil placed in between.	6-8	For short-term storage, it can be left in its original packaging. For long-term storage, it should also be wrapped in aluminum or plastic foil.
Butter, margarine	In its own packaging	6	In its original packaging or plastic containers

"The storage times indicated in the table are based on a storage temperature of -18°C."

"The quantity of fresh food that can be frozen within a specific time period is indicated on the type label."

Freezer Information

According to IEC 62552 standards, for every 100 liters of freezer compartment volume, the product must be able to freeze 4.5 kg of food at 25°C room temperature for 24 hours at -18°C or lower.

Food can only be preserved for extended periods at temperatures of -18°C and below.

You can preserve the freshness of food items for months (in a deep freezer at temperatures of -18°C and lower).

Foods to be frozen should not be brought into contact with previously frozen foods to prevent partial thawing.

To extend the storage time of frozen vegetables, blanch them and drain the water.

After draining, place them in airtight containers and put them in the freezer. Foods such as bananas, tomatoes, lettuce, celery, hard-boiled eggs, and potatoes are not suitable for freezing. Freezing these foods will only negatively affect their nutritional value and eating quality. There is no risk of spoilage that threatens human health.

Food Placement

Freezer compartment shelves: Various frozen foods such as meat, fish, ice cream, vegetables, etc.

Refrigerator compartment shelves: Food in pots, covered dishes and covered containers, eggs (in a covered container)

Refrigerator compartment door shelves: Small, packaged food or beverages

Vegetable storage: Vegetables and fruits

Fresh food compartment: Deli products (breakfast items, meat products to be consumed quickly)

6.3 Crisper

The vegetable compartment of the product is specifically designed to keep vegetables fresh without losing moisture. For this purpose, cold air circulation is concentrated throughout the vegetable compartment. Store your vegetables and fruits in this compartment. To ensure longer storage, do not place leafy green vegetables next to fruits.

6.4 Crisper Technologies

Fruits and vegetables stored in vegetable drawers illuminated with technology retain their antioxidant values for longer thanks to blue, green, and red lights and dark cycles that simulate the day cycle. With this innov-

ative technology, we not only use the power of colors to preserve food quality but also transform it into a visual experience. Each time the door of your product is opened, the vegetable drawer will be illuminated with Red, Yellow, Green, Purple, or Orange colors in sequence, providing both easy visibility in the dark and a vibrant and dynamic visual experience for the user. The dark period will continue when you close your product, representing the night period in the day cycle.

6.5 Dairy Products Cold Storage Area

Cold Storage Compartment

The Cold Storage Compartment provides a lower temperature inside the product. Use this compartment to store deli products (salami, sausages, dairy products, etc.) or meat, chicken, and fish products that need to be kept at a lower temperature for immediate consumption. Do not store fruits and vegetables in this compartment.

6.6 Reversing the Door Opening Side

The door opening side of your refrigerator can be reversed according to the place you put it. For the products that include electronic display when you need this, you should definitely call the nearest Authorized Service.

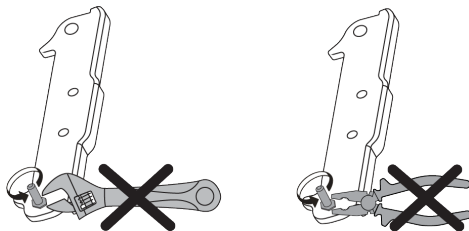

6.7 Door Open Alert

The door open alert system of your refrigerator may differ depending on the model.

Version 1;

If the door of the product remains open for a certain time (between 60 s and 120 s), an audio warning signal sounds; depending on the product model, a visual warning signal

(light flash) can also be displayed. If you close the door of the device or press a button on the screen of the device, if any, the warning sound will stop.

Version 2;

If the door of the device remains open for a certain period of time (between 60 s and 120 s), the door open alert is sounded. The door open alert is sounded gradually. First, an audible warning starts to sound. After 4 minutes, if the door is still not closed, a visual warning (lighting flash) is activated. The door open alert will be delayed for a certain period of time (between 60 s and 120 s) when any key on the product screen,

if any, is pressed. Then the process will start again. When the device door is closed, the door open alert will be cancelled.

6.8 Replacing the Illumination Lamp

Call the Authorized Service when the Bulb/LED used for lighting in your refrigerator will be replaced.

Lamp(s) used in this appliance cannot be used for house lighting. Intended use of this lamp is to help the user place food into the refrigerator / freezer safely and comfortably.

This product contains a lighting source with 'G' energy class.

The lighting source in this product must be replaced by a qualified repair person.

7 Maintenance and Cleaning

Read the "Safety Instructions" first!

- Unplug your appliance before cleaning it.
- The dust on the ventilation grille on the back of the product should be removed (without opening the lid) at least once a year. Cleaning should be done with a dry cloth.
- Be careful not to let water get into the lamp housing and other electrical parts.
- Clean the door with a damp cloth. Remove all contents to take out the door and body shelves. Lift the door shelves upwards to remove them. After cleaning and drying, slide them back in place from top to bottom.
- Never use chlorine-containing water or cleaning agents for cleaning the exterior surface of the product or chrome-plated parts. Chlorine causes rust on these types of metal surfaces.
- To prevent the prints on the plastic part from peeling off or deforming, do not use sharp, abrasive tools, soap, household cleaning products, detergents, gasoline, polish, etc. For cleaning, use a soft cloth with lukewarm water and dry.
- In products without No Frost technology; water droplets and up to a finger's thickness of frost will form on the back wall of

the cooling compartment. Do not clean it, and absolutely do not apply oil or similar substances.

- Use only a slightly damp microfiber cloth for cleaning the exterior surface of the product. Sponges and other types of cleaning cloths may cause scratches.
- To clean the interior surfaces of the product, wash all removable parts with a mild solution of soap, water, and baking soda. Rinse thoroughly and dry completely. Prevent water from getting into the lights and control panel.
- Do not use vinegar, rubbing alcohol, or other alcohol-based cleaners on any interior surfaces.

Stainless Steel Exterior Surfaces

Use a non-abrasive stainless steel cleaner and apply it with a lint-free, soft cloth. To polish, gently wipe the surface with a microfiber cloth dampened with water and use a dry polishing pad. Always follow the grain of the stainless steel.

Preventing Bad Odors

No substances that could cause odor are used in the production of your product. However, odors may arise due to improper food storage and failure to properly clean the product's interior surface.

- To prevent this problem, clean with baking soda water every 15 days.
- Store food in sealed containers, as microorganisms released from open food can cause bad odors.

- Never store expired or spoiled food in your product.

Protection of Plastic Surfaces

If oil spills on plastic surfaces, clean them immediately with warm water, as the oil can damage the surface.

8 Troubleshooting

Read the "Safety Instructions" first!

Check this list before contacting the service. Doing so will save you time and money. This list includes frequent complaints that are not related to faulty workmanship or materials. Certain features mentioned herein may not apply to your product.

If the problem persists after following the instructions in this section, contact your vendor or an Authorized Service. Do not try to repair the product.

The refrigerator is not working.

- The power plug is not fully settled. >>> Plug it in to settle completely into the socket.
- The fuse connected to the socket powering the product or the main fuse is blown. >>> Check the fuse.

Condensation on the side wall of the cooler compartment (MULTI ZONE, COOL CONTROL and FLEXI ZONE).

- The door is opened too frequently. >>> Take care not to open the product's door too frequently.
- The environment is too humid. >>> Do not install the product in humid environments.
- Foods containing liquids are kept in unsealed holders. >>> Keep the foods containing liquids in sealed holders.
- The product's door is left open. >>> Do not keep the product's door open for long periods.
- The thermostat is set to a very cool temperature. >>> Set the thermostat to an appropriate temperature.

Compressor is not working.

- In case of sudden power failure or pulling the power plug off and putting back on, the gas pressure in the product's cooling system is not balanced, which triggers the compressor thermic safeguard. The product will restart after approximately 6 minutes. If the product does not restart after this period, contact the service.
- Defrosting is active. >>> This is normal for a fully-automatic defrosting product. The defrosting is carried out periodically.
- The product is not plugged in. >>> Make sure the power cord is plugged in.
- The temperature setting is incorrect. >>> Select the appropriate temperature setting.
- The power is out. >>> The product will continue to operate normally once the power is restored.

The refrigerator's operating noise is increasing while in use.

- The product's operating performance may vary depending on the ambient temperature variations. This is normal and not a malfunction.

The refrigerator runs too often or for too long.

- The new product may be larger than the previous one. Larger products will run for longer periods.
- The room temperature may be high. >>> The product will normally run for long periods in higher room temperature.
- The product may have been recently plugged in or a new food item is placed inside. >>> The product will take longer to reach the set temperature when recently plugged in or a new food item is placed inside. This is normal.

- Large quantities of hot food may have been recently placed into the product. >>> Do not place hot food into the product.
- The doors were opened frequently or kept open for long periods. >>> The warm air moving inside will cause the product to run longer. Do not open the doors too frequently.
- The freezer or cooler door may be ajar. >>> Check that the doors are fully closed.
- The product may be set to a temperature that is too low. >>> Set the temperature to a higher degree and wait for the product to reach the adjusted temperature.
- The cooler or freezer door washer may be dirty, worn out, broken or not properly settled. >>> Clean or replace the gasket. Damaged / torn door washer will cause the product to run for longer periods to preserve the current temperature.

The freezer temperature is very low, but the cooler temperature is adequate.

- The freezer compartment temperature is set to a very low degree. >>> Set the freezer compartment temperature to a higher degree and check again.

The cooler temperature is very low, but the freezer temperature is adequate.

- The cooler compartment temperature is set to a very low degree. >>> Set the cooler compartment temperature to a higher degree and check again.

The food items kept in cooler compartment drawers are frozen.

- The cooler compartment temperature is set to a very low degree. >>> Set the cooler compartment temperature to a higher degree and check again.

The temperature in the cooler or the freezer is too high.

- The cooler compartment temperature is set to a very high degree. >>> Temperature setting of the cooler compartment has an effect on the temperature in the freezer compartment. Wait until the tem-

perature of relevant parts reach the sufficient level by changing the temperature of cooler or freezer compartments.

- The doors were opened frequently or kept open for long periods. >>> Do not open the doors too frequently.
- The door may be ajar. >>> Fully close the door.
- The product may have been recently plugged in or a new food item is placed inside. >>> This is normal. The product will take longer to reach the set temperature when recently plugged in or a new food item is placed inside.
- Large quantities of hot food may have been recently placed into the product. >>> Do not place hot food into the product.

Shaking or noise.

- The surface is not flat or durable >>> If the product is shaking when moved slowly, adjust the stands to balance the product. Also make sure the ground is sufficiently durable to bear the product.
- Any items placed on the product may cause noise. >>> Remove any items placed on the product.
- The product is making noise of liquid flowing, spraying etc.
- The product's operating principles involve liquid and gas flows. >>> This is normal and not a malfunction.

There is sound of wind blowing coming from the product.

- The product uses a fan for the cooling process. This is normal and not a malfunction.

There is condensation on the product's internal walls.

- Hot or humid weather will increase icing and condensation. This is normal and not a malfunction.
- The doors were opened frequently or kept open for long periods. >>> Do not open the doors too frequently; if open, close the door.
- The door may be ajar. >>> Fully close the door.

There is condensation on the product's exterior or between the doors.

- The ambient weather may be humid, this is quite normal in humid weather. >>> The condensation will dissipate when the humidity is reduced.

The interior smells bad.

- The product is not cleaned regularly. >>> Clean the interior regularly using sponge, warm water and carbonated water.
- Certain holders and packaging materials may cause odour. >>> Use holders and odour-free packaging materials.
- The foods were placed in unsealed holders. >>> Keep the foods in sealed holders. Micro-organisms may spread out of unsealed food items and cause bad odour.
- Remove any expired or spoilt foods from the product.

The door is not closing.

- Food packages may be blocking the door. >>> Relocate any items blocking the doors.

- The product is not standing in full upright position on the ground. >>> Adjust the stands to balance the product.
- The surface is not flat or durable >>> Make sure the surface is flat and sufficiently durable to bear the product.

The crisper is jammed.

- The food items may be in contact with the upper section of the drawer. >>> Re-organize the food items in the drawer.

Temperature on the product surface.

- High temperature may be observed between two doors, on the side panels and on the rear grill area while your product is operated. This is normal and it does not require servicing.

Fan continues to operate when the door is opened.

- Fan may continue to operate when the freezer door is open.

If the problem persists after following the instructions in this section, contact your vendor or an Authorized Service. Do not try to repair the product. This is normal.

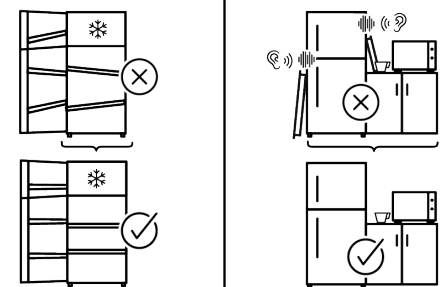
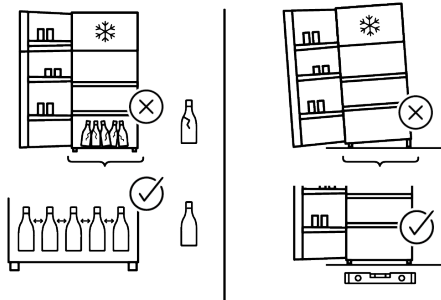
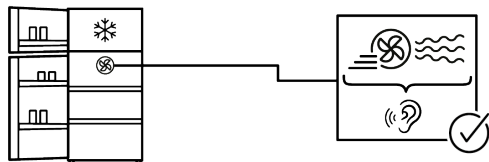
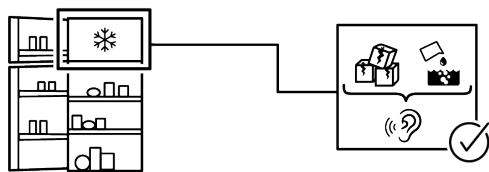
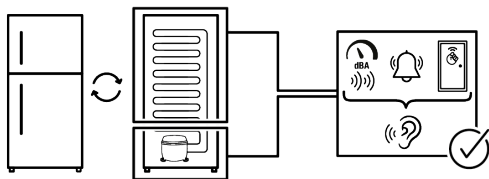

Please scan the QR code which places on the outer packaging of the product to find all the information relating to the packaging and how to manage the packaging waste.

DISCLAIMER

Some (simple) failures can be adequately handled by the end-user without any safety issue or unsafe use arising, provided that they are carried out within the limits and in accordance with the following instructions (see the "Self-Repair" section).

Therefore, unless otherwise authorized in the "Self-Repair" section below, repairs shall be addressed to registered professional repairers in order to avoid safety issues. A registered Professional repairer is a professional repairer that has been granted access to the instructions and spare parts list of this product by the manufacturer according to the methods described in legislative acts pursuant to Directive 2009/125/EC.

However, only the service agent (i.e. authorized professional repairers) that you can reach through the phone number given in the user manual/warranty card or through your authorized dealer may provide service under the guarantee terms. Therefore, please be advised that repairs by professional repairers (who are not authorized by) shall void the guarantee.

Self-Repair

Self-repair can be done by the end-user with regard exclusively to the following spare parts: door handles, door hinges, trays, baskets and door gaskets (an updated list is also available as of 1st March 2021).

Moreover, to ensure product safety and to prevent risk of serious injury, the mentioned self-repair shall be done following the instructions in the user manual for self-repair or which are available in . For your safety, unplug the product before attempting any self-repair.

Repair and repair attempts by end-users for parts not included in such list and/or not following the instructions in the user manuals for self-repair or which are available in ,

might give rise to safety issues not attributable to , and will void the warranty of the product.

Therefore, it is highly recommended that end-users refrain from the attempt to carry out repairs falling outside the mentioned list of spare parts, contacting in such cases authorized professional repairers or registered professional repairers. On the contrary, such attempts by end-users may cause safety issues and damage the product and subsequently cause fire, flood, electrocution and serious personal injury to occur.

By way of example, but not limited to, the following repairs must be addressed to authorized professional repairers: compressor, cooling circuit, main board, inverter board, display board, etc.

The manufacturer/seller cannot be held liable in any case where end-users do not comply with the above.

The spare part availability of the refrigerator that you purchased is 10 years. During this period, original spare parts will be available to operate the refrigerator properly. The minimum duration of guarantee of the refrigerator that you purchased is 24 months.

This product is equipped with a lighting source of the "G" energy class.

The lighting source in this product shall only be replaced by Professional repairer.

