

- EN **Use and Care guide**
- FR **Guide d'utilisation et entretien**
- IT **Istruzioni per l'uso**
- ES **Guía de uso y cuidado**
- PT **Guia de Utilização e Manutenção**
- EL **Οδηγός χρήσης και συντήρησης**

ENGLISH

SAFETY INSTRUCTIONS	5
DAILY REFERENCE GUIDE	7
Installation guide	89

FRANÇAIS

CONSIGNES DE SÉCURITÉ	19
GUIDE D'UTILISATION QUOTIDIENNE	21
Consignes d'installation	89

ITALIANO

NORME DI SICUREZZA	33
GUIDA RAPIDA	35
Istruzioni per l'installazione	89

ESPAÑOL

INSTRUCCIONES DE SEGURIDAD	47
GUÍA DE CONSULTA DIARIA	49
Guía de instalación	89

PORTUGUÊS

INSTRUÇÕES DE SEGURANÇA	61
GUIA DE CONSULTA DIÁRIA	63
Guia de Instalação	89

ΕΛΛΗΝΙΚΑ

ΟΔΗΓΙΕΣ ΓΙΑ ΤΗΝ ΑΣΦΑΛΕΙΑ	75
ΚΑΘΗΜΕΡΙΝΟΣ ΟΔΗΓΟΣ ΑΝΑΦΟΡΑΣ	77
Οδηγός εγκατάστασης	89

SAFETY INSTRUCTIONS

Before using the appliance, read these safety instructions. Keep them nearby for future reference. These instructions and the appliance itself provide important safety warnings, to be observed at all times. The manufacturer declines any liability for failure to observe these safety instructions, for inappropriate use of the appliance or incorrect setting of controls.

⚠ Very young children (0-3 years) should be kept away from the appliance. Young children (3-8 years) should be kept away from the appliance unless continuously supervised. Children from 8 years old and above and persons with reduced physical, sensory or mental capabilities or lack of experience and knowledge can use this appliance only if they are supervised or have been given instructions on safe use and understand the hazards involved. Children must not play with the appliance. Cleaning and user maintenance must not be carried out by children without supervision.

⚠ **WARNING:** The appliance and its accessible parts become hot during use. Care should be taken to avoid touching heating elements. Children less than 8 years of age must be kept away unless continuously supervised.

⚠ Never leave the appliance unattended during food drying. If the appliance is suitable for probe usage, only use a temperature probe recommended for this oven - risk of fire.

⚠ Keep clothes or other flammable materials away from the appliance, until all the components have cooled down completely - risk of fire. Always be vigilant when cooking foods rich in fat, oil or when adding alcoholic beverages - risk of fire. Use oven gloves to remove pans and accessories. At the end of cooking, open the door with caution, allowing hot air or steam to escape gradually before accessing the cavity - risk of burns. Do not obstruct hot air vents at the front of the oven - risk of fire.

⚠ Exercise caution when the oven door is in the open or down position, to avoid hitting the door.

PERMITTED USE

⚠ **CAUTION:** The appliance is not intended to be operated by means of an external switching device, such as a timer, or separate remote controlled system.

⚠ This appliance is intended to be used in household and similar applications such as: staff kitchen areas in shops, offices and other working environments; farm houses; by clients in hotels, motels, bed & breakfast and other residential environments.

⚠ No other use is permitted (e.g. heating rooms).

⚠ This appliance is not for professional use. Do not use the appliance outdoors.

⚠ Do not store explosive or flammable substances (e.g. gasoline or aerosol cans) inside or near the appliance - risk of fire.

IMPORTANT TO BE READ AND OBSERVED

INSTALLATION

⚠ The appliance must be handled and installed by two or more persons - risk of injury. Use protective gloves to unpack and install - risk of cuts.

⚠ Installation, including water supply (if any), electrical connections and repairs must be carried out by a qualified technician. Do not repair or replace any part of the appliance unless specifically stated in the user manual. Keep children away from the installation site. After unpacking the appliance, make sure that it has not been damaged during transport. In the event of problems, contact the dealer or your nearest After-sales Service. Once installed, packaging waste (plastic, styrofoam parts etc.) must be stored out of reach of children - risk of suffocation. The appliance must be disconnected from the power supply before any installation operation - risk of electric shock. During installation, make sure the appliance does not damage the power cable - risk of fire or electric shock. Only activate the appliance when the installation has been completed.

⚠ Carry out all cabinet cutting operations before fitting the appliance and remove all wood chips and sawdust.

Do not obstruct the minimum gap between the worktop and the upper edge of the oven - risk of burns.

Do not remove the oven from its polystyrene foam base until the time of installation.

⚠ After installation, the bottom of the appliance must no longer be accessible - risk of burns.

⚠ Do not install the appliance behind a decorative door - risk of fire.

ELECTRICAL WARNINGS

⚠ The rating plate is on the front edge of the oven (visible when the door is open).

⚠ It must be possible to disconnect the appliance from the power supply by unplugging it if plug is accessible, or by a multi-pole switch installed upstream of the socket in accordance with the wiring rules and the appliance must be earthed in conformity with national electrical safety standards.

⚠ Do not use extension leads, multiple sockets or adapters. The electrical components must not be accessible to the user after installation. Do not use the appliance when you are wet or barefoot. Do not operate this appliance if it has a damaged power cable or plug, if it is not working properly, or if it has been damaged or dropped.

⚠ If the supply cord is damaged, it must be replaced with an identical one by the manufacturer, its service agent or similarly qualified persons in order to avoid a hazard - risk of electric shock.

⚠ In case of replacement of power cable, contact an authorised service centre.

CLEANING AND MAINTENANCE

 **WARNING:** Ensure that the appliance is switched off and disconnected from the power supply before performing any maintenance operation; never use steam cleaning equipment - risk of electric shock.

 Do not use harsh abrasive cleaners or metal scrapers to clean the door glass since they can scratch the surface, which may result in shattering of the glass.

 Ensure the appliance is cooled down before any cleaning or maintenance - risk of burns.

 **WARNING:** Switch off the appliance before replacing the lamp - risk of electric shock.

DISPOSAL OF PACKAGING MATERIALS

The packaging material is 100% recyclable and is marked with the recycle symbol .

The various parts of the packaging must therefore be disposed of responsibly and in full compliance with local authority regulations governing waste disposal.

DISPOSAL OF HOUSEHOLD APPLIANCES

This appliance is manufactured with recyclable or reusable materials. Dispose of it in accordance with local waste disposal regulations. For further information on the treatment, recovery and recycling of household electrical appliances, contact your local authority, the collection service for household waste or the store where you purchased the appliance. This appliance is marked in compliance with European Directive 2012/19/EU, Waste Electrical and Electronic Equipment (WEEE) and with the Waste Electrical and Electronic Equipment regulations 2013 (as amended).

By ensuring this product is disposed of correctly, you will help prevent negative consequences for the environment and human health.

The symbol  on the product or on the accompanying documentation indicates that it should not be treated as domestic waste but must be taken to an appropriate collection centre for the recycling of electrical and electronic equipment.

ENERGY SAVING TIPS

Only preheat the oven if specified in the cooking table or your recipe. Use dark lacquered or enamelled baking trays as they absorb heat better. Food requiring prolonged cooking will continue to cook even once the oven is switched off.

ECO DESIGN DECLARATION

This appliance meets: Ecodesign requirements of European Regulation 66/2014; Energy Labelling Regulation 65/2014; Ecodesign for Energy-Related Products and Energy Information (Amendment) (EU Exit) Regulations 2019, in compliance with the European standard EN 60350-1.

DAILY REFERENCE GUIDE



THANK YOU FOR PURCHASING A WHIRLPOOL PRODUCT

To receive more comprehensive help and support, please register your product at www.whirlpool.eu/register



You can download the Safety Instructions and the Use and Care Guide by visiting our website docs.whirlpool.eu and following the instructions on the back of this booklet.



Before using the appliance carefully read the Health and Safety guide.

PRODUCT DESCRIPTION

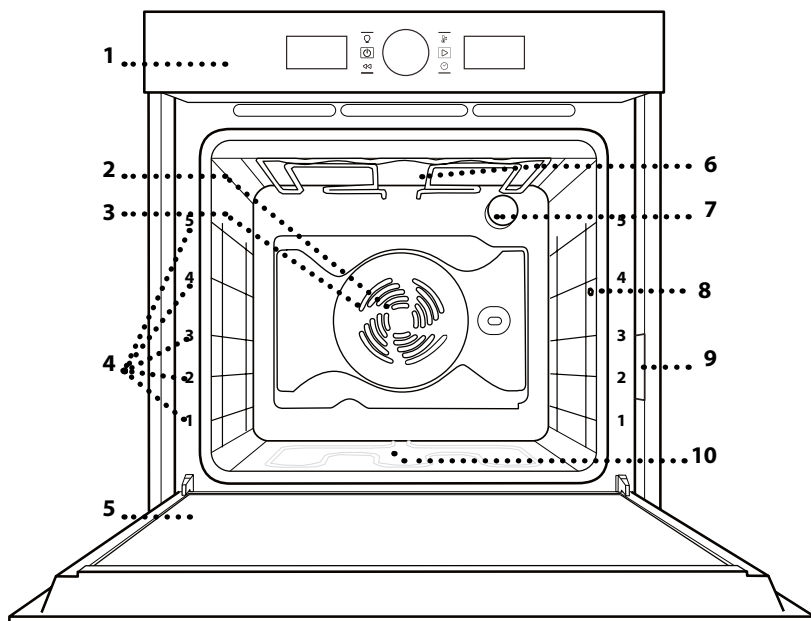

1. Control panel
2. Fan
3. Circular heating element (not visible)
4. Shelf guides (the level is indicated on the front of the oven)
5. Door
6. Upper heating element/grill
7. Lamp
8. Meat probe insert point (if present)
9. Identification plate (do not remove)
10. Lower heating element (not visible)

CONTROL PANEL

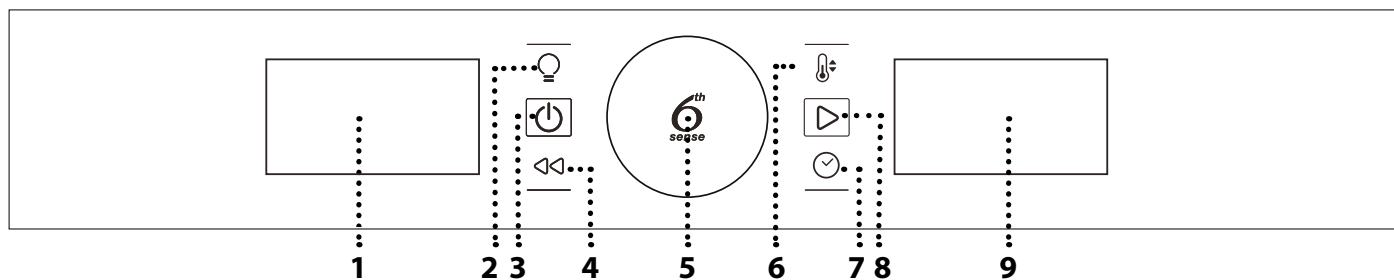

1. LEFT-HAND DISPLAY

2. LIGHT

For switching the lamp on/off.

3. ON/OFF

For switching the oven on and off and for stopping an active function at any time.

4. BACK

For returning to the previous menu when configuring settings.

5. ROTARY KNOB / 6TH SENSE BUTTON

Turn this to navigate through the functions and adjust all of the cooking parameters. Press  to select, set, access or confirm functions or parameters and eventually start the cooking program.

6. TEMPERATURE

For setting the temperature.

7. TIME

For setting or changing the time and adjusting the cooking time.

8. START

For starting functions and confirming settings.

9. RIGHT-HAND DISPLAY

ACCESSORIES

WIRE SHELF

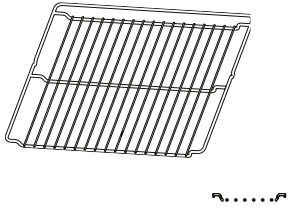

DRIP TRAY

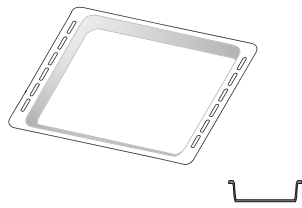

BAKING TRAY

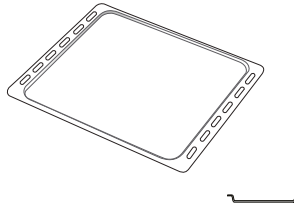

SLIDING RUNNERS (ONLY IN SOME MODELS)

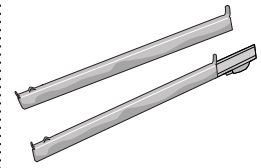

MEAT PROBE (ONLY IN SOME MODELS)

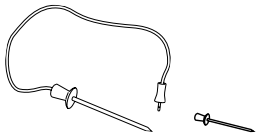

The number of accessories may vary depending on which model is purchased. Other accessories can be purchased separately from the After-sales Service.

INSERTING THE WIRE SHELF AND OTHER ACCESSORIES

Insert the wire shelf horizontally by sliding it across the shelf guides, making sure that the side with the raised edge is facing upwards.

Other accessories, such as the drip tray and the baking tray, are inserted horizontally in the same way as the wire shelf.

FITTING THE SLIDING RUNNERS (IF PRESENT)

Remove the shelf guides from the oven and remove the protective plastic from the sliding runners.

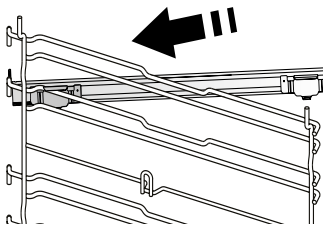

Fasten the upper clip of the runner to the shelf guide and slide it along as far as it will go. Lower the other clip into position.

To secure the guide, press the lower portion of the clip firmly against the shelf guide. Make sure that the runners can move freely. Repeat these steps on the other shelf guide on the same level.

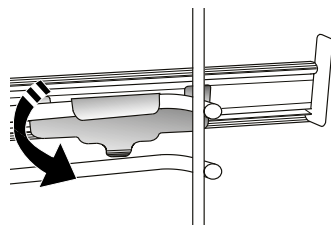

Please note: The sliding runners can be fitted on any level.

REMOVING AND REFITTING THE SHELF GUIDES

See pictures (Fig. 1, 2, 3) to remove lateral supports and (if present) cavity nuts that retain the same.

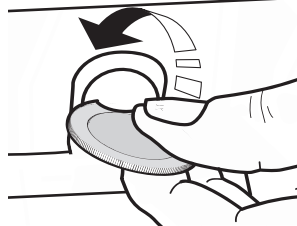
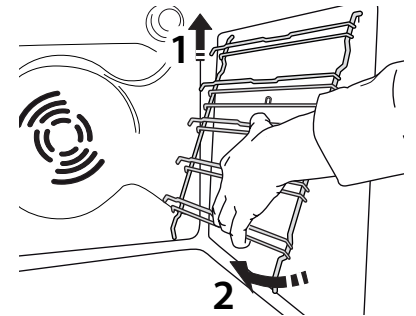
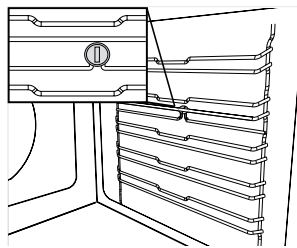

To refit the shelf guides, first fit them back into their upper seating. Keeping them held up, slide them into the cooking compartment, then lower them into position in the lower seating.

FUNCTIONS



CONVENTIONAL

For cooking any kind of dish on one shelf only.



GRILL

For grilling steaks, kebabs and sausages, cooking vegetables au gratin or toasting bread. When grilling meat, we recommend using a drip tray to collect the cooking juices: Position the tray on any of the levels below the wire shelf and add 500 ml of drinking water.



FORCED AIR

For cooking different foods that require the same cooking temperature on several shelves (maximum three) at the same time. This function can be used to cook different foods without odours being transferred from one food to another.



CONVECTION BAKE

For cooking meat, baking cakes with fillings or roasting stuffed vegetables on one shelf only. This function uses gentle, intermittent air circulation to prevent food from drying out excessively.



6TH SENSE FUNCTIONS



CASSEROLE

This function automatically selects the best temperature and cooking method for pasta dishes.



MEAT

This function automatically selects the best temperature and cooking method for meat. This function intermittently activates the fan at low speed to prevent the food from drying out too much.



MAXI COOKING

The function automatically selects the best cooking mode and temperature to cook large joints of meat (above 2.5 kg). It is advisable to turn the meat over during cooking, to obtain even browning on both sides. It is best to baste the meat every now and again to prevent it from drying out.



BREAD

This function automatically selects the best temperature and cooking method for all types of bread.



PIZZA

This function automatically selects the best temperature and cooking method for all types of pizza.



PASTRY CAKES

This function automatically selects the best temperature and cooking method for all types of cake.



SPECIAL FUNCTIONS



FAST PREHEATING

For preheating the oven quickly. Once preheating has finished, the oven will select the "Conventional" function automatically. Wait for preheating to finish before placing food in the oven.



TURBO GRILL

For roasting large joints of meat (legs, roast beef, chicken). We recommend using a drip tray to collect the cooking juices: Position the pan on any of the levels below the wire shelf and add 500 ml of drinking water. The turnspit (if provided) can be used with this function.



ECO FORCED AIR*

For cooking stuffed roasting joints and fillets of meat on a single shelf. Food is prevented from drying out excessively by gentle, intermittent air circulation. When this ECO function is in use, the light will remain switched off during cooking. To use the ECO cycle and therefore optimise power consumption, the oven door should not be opened until the food is completely cooked.



KEEP WARM

For keeping just-cooked food hot and crisp.



RISING

For optimal proving of sweet or savoury dough. To maintain the quality of proving, do not activate the function if the oven is still hot following a cooking cycle.



SMART CLEAN

(ONLY IN SOME MODELS)

The action of the steam released during this special low-temperature cleaning cycle allows dirt and food residues to be removed with ease. Pour 200 ml of drinking water on the bottom of the oven and only activate the function when the oven is cold.

* Function used as reference for the energy efficiency declaration in accordance with Regulation (EU) No. 65/2014

USING THE APPLIANCE FOR THE FIRST TIME

1. SET THE TIME

You will need to set the time when you switch on the oven for the first time.



The two digits for the hour will start flashing: Turn the knob to set the hour and press to confirm.



The two digits for the minutes will start flashing. Turn the knob to set the minutes and press to confirm.

Please note: To change the time at a later point, press and hold for at least one second while the oven is off and repeat the steps above.

You may need to set the time again following lengthy power outages.

2. SETTINGS

If required, you can change the default unit of measurement, temperature (°C) and rated current (16 A).

With the oven off, press and hold for at least 5 seconds.



Turn the selection knob to select the unit of measurement, then press to confirm.



Turn the selection knob to select the rated current, then press to confirm.

Please note: The oven is programmed to consume a level of electrical power that is compatible with a domestic network that has a rating of more than 3 kW (16 A): If your household uses a lower power, you will need to decrease this value (13 A).

3. HEAT THE OVEN

A new oven may release odours that have been left behind during manufacturing: this is completely normal.

Before starting to cook food, we therefore recommend heating the oven with it empty in order to remove any possible odours.

Remove any protective cardboard or transparent film from the oven and remove any accessories from inside it.

Heat the oven to 200 °C for around one hour, ideally using a function with air circulation (e.g. "Forced Air" or "Convection Bake").

Follow the instructions for setting the function correctly.

Please note: It is advisable to air the room after using the appliance for the first time.

DAILY USE

1. SELECT A FUNCTION

When the oven is off, only the time is shown on the display. Press and hold to switch the oven on. Turn the knob to view the main functions available on the left-hand display. Select one and press .

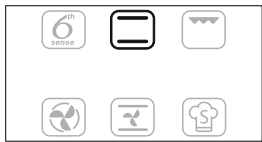

To select a sub-function (where available), select the main function and then press to confirm and go to the function menu.

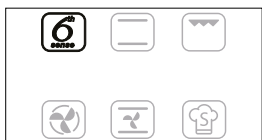

Turn the knob to view the sub-functions available on the right-hand display. Select one and press to confirm.

2. SET THE FUNCTION

After having selected the function you require, you can change its settings.

The display will show the settings that can be changed in sequence.

TEMPERATURE/GRILL LEVEL



When the °C/°F icon flashes on the display, turn the knob to change the value, then press to confirm and continue to alter the settings that follow (if possible).

You can also set the grill level (3 = high, 2 = medium, 1 = low) at the same time.



Please note: Once the function has started, you can change the temperature or the grill level by pressing or by turning the knob directly.

DURATION



When the icon flashes on the display, use the adjustment knob to set the cooking time you require and then press to confirm.

You do not have to set the cooking time if you want to manage cooking manually: Press to confirm and start the function.

In this case, you cannot set the end cooking time by programming a delayed start.

Please note: You can adjust the cooking time that has been set during cooking by pressing : Turn the knob to change the hour and press to confirm.

SETTING THE END COOKING TIME/ DELAYED START

In many functions, once you have set a cooking time you can delay starting the function by programming its end time.

Where you can change the end time, the display will show the time the function is expected to finish while the icon flashes.



If necessary, turn the knob to set the time you want cooking to end, then press to confirm and start the function.

Place the food in the oven and close the door: The function will start automatically after the period of time that has been calculated in order for cooking to finish at the time you have set.



Please note: Programming a delayed cooking start time will disable the oven preheating phase. The oven will reach the temperature you require gradually, meaning that cooking times will be slightly longer than those listed in the cooking table.

During the waiting time, you can use the knob to change the programmed end time.

Press or to change the temperature and cooking time settings. Press to confirm when finished.

Please note: Delay to start functionality is not available for Grill and Turbo Grill functions.

3. ACTIVATE THE FUNCTION

Once you have applied the settings you require, press to activate the function.

You can press and hold at any time to pause the function that is currently active.

4. PREHEATING

Some functions have an oven preheating phase: Once the function has started, the display indicates that the preheating phase has been activated.

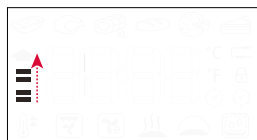

Once this phase has finished, an audible signal will sound and the display will indicate that the oven has reached the set temperature.



At this point, open the door, place the food in the oven, close the door and start cooking by pressing .

Please note: Placing the food in the oven before preheating has finished may have an adverse effect on the final cooking result.

Opening the door during the preheating phase will pause it.

The cooking time does not include a preheating phase.

You can always change the temperature you want to reach using the knob.

5. END OF COOKING

An audible signal will sound and the display will indicate that cooking is complete.



To extend the cooking time without changing the settings, turn the knob to set a new cooking time and press .

. 6th SENSE FUNCTIONS

TEMPERATURE RECOVERY

If the temperature inside the oven decreases during a cooking cycle because the door is opened, a special function will be activated automatically to restore the original temperature.

While the temperature is being restored, the display will show a "snake" animation until the set temperature has been reached.

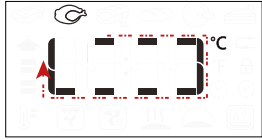

While a programmed cooking cycle is in progress, the cooking time will be increased according to how long the door was open in order to guarantee best results.

. SPECIAL FUNCTIONS

SMART CLEAN

To activate the "Smart Clean" function, with the oven cold, distribute 200 ml of water on the bottom of the oven cavity, then close the oven door.

Access special functions and turn the knob to select from menu. then press to confirm.

Press to start immediately the cleaning cycle, or press to set the end time/start delayed.

At the end of the cycle, let the oven cooling down and remove any residual water in the oven and start cleaning using a sponge moistened with hot water (cleaning could be compromised if delayed by more than 15 minutes).

Please note: The duration and temperature of cleaning cycle cannot be set

. USING THE MEAT PROBE (IF PRESENT)

The meat probe supplied allows to measure the exact internal temperature of food during cooking.

The meat probe is allowed only in some cooking function (Conventional, Forced Air, Convection Bake, Turbo Grill, 6th Sense Meat and 6th Sense Maxicooking).

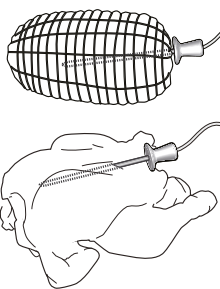

It is very important to position the probe accurately in order to obtain perfect cooking results. Insert the probe fully into the fleshiest part of the meat, avoiding bones and fatty parts.

For poultry, the probe should be inserted sideways, in the middle of the breast, taking care to ensure the tip does not end up in a hollow part. In the case of meat with very irregular thickness, check it is

cooked properly before removing it from the oven. Connect the end of the probe in the hole located on the right wall of the oven cavity.

When the meat probe is plugged to the oven cavity, a buzzer sounds and the display shows icon and target temperature.

If the meat probe is plugged during the selection of a function, display switches to the default meat probe target temperature.



Press to start settings. Turn the knob to set the meat probe target temperature. Press to confirm. Turn the knob to set oven cavity temperature.



Press or to confirm and start the cooking cycle.

During cooking cycle, the display shows meat probe target temperature. When the meat reaches the target temperature set, the cooking cycle stops and the display shows "End".

To restart the cooking cycle from "End", by turning the knob it is possible to adjust meat probe target temperature as indicated above. Press or to confirm and restart the cooking cycle.

Please note: during cooking cycle with meat probe it is possible turn the knob to change meat probe target temperature. Press to adjust oven cavity temperature. The meat probe can be inserted at any time, also during a cooking cycle. In this case, it is necessary re-set the cooking function parameters.

If meat probe is incompatible with a function, the oven switch off the cooking cycle and plays an alert buzzer sound. In this case, disconnect the meat probe or press to set another function. Start delayed and preheat phase are not compatible with meat probe.

. KEY LOCK

To lock the keypad, press and hold for at least 5 seconds.



Do this again to unlock the keypad.

Please note: The key lock can also be activated while cooking is in progress.

For safety reasons, the oven can be switched off at any time by pressing .

USEFUL TIPS

HOW TO READ THE COOKING TABLE

The table lists the best function, accessories and level to use to cook different types of food. Cooking times start from the moment food is placed in the oven, excluding preheating (where required). Cooking temperatures and times are approximate and depend on the amount of food and the type of accessory used. Use the lowest recommended settings to begin with and, if the food is not cooked enough, then switch to higher settings. Use the accessories supplied and preferably dark-coloured metal cake tins and baking trays. You can also use Pyrex or stoneware pans and accessories, but bear in mind that cooking times will be slightly longer.

COOKING DIFFERENT FOODS AT THE SAME TIME

Using the "Forced Air" function, you can cook different foods which require the same cooking temperature at the same time (for example: fish and vegetables), using different shelves. Remove the food which requires a shorter cooking time and leave the food which requires a longer cooking time in the oven.

MEAT

Use any kind of oven tray or pyrex dish suited to the size of the piece of meat being cooked. For roast joints, it is best to add some stock to the bottom of the dish, basting the meat during cooking for added flavour. Please note that steam will be generated during this operation. When the roast is ready, let it rest in the oven for another 10-15 minutes, or wrap it in aluminium foil.

When you want to grill meat, choose cuts with an even thickness all over in order to achieve uniform cooking results. Very thick pieces of meat require longer cooking times. To prevent the meat from burning on the outside, lower the position of the wire shelf, keeping the food farther away from the grill. Turn the meat two thirds of the way through cooking. Take care when opening the door as steam will escape.

To collect the cooking juices, we recommend placing a dripping pan filled with half a litre of drinking water directly underneath the wire shelf on which the food is placed. Top-up when necessary.

DESSERTS

Cook delicate desserts with the conventional function on one shelf only.

Use dark-coloured metal baking pans and always place them on the wire shelf supplied. To cook on more than one shelf, select the forced air function and stagger the position of the cake tins on the shelves, aiding optimum circulation of the hot air.

To check whether a leavened cake is cooked, insert a wooden toothpick into the centre of the cake. If the toothpick comes out clean, the cake is ready.

If using non-stick baking pans, do not butter the edges as the cake may not rise evenly around the edges.

If the item "swells" during baking, use a lower temperature next time and consider reducing the amount of liquid you add or stirring the mixture more gently.

For desserts with moist fillings or toppings (such as cheesecake or fruit tarts), use the "Convection bake" function. If the base of the cake is soggy, lower the shelf and sprinkle the bottom of the cake with breadcrumbs or biscuit crumbs before adding the filling.

















































































PIZZA

Lightly grease the trays to ensure the pizza has a crispy base. Scatter the mozzarella over the pizza two thirds of the way through cooking.

RISING

It is always best to cover the dough with a damp cloth before placing it in the oven. Dough proving time with this function is reduced by approximately one third compared to proving at room temperature (20-25°C). The rising time for pizza starts at around one hour for 1 kg of dough.

COOKING TABLE

RECIPE	FUNCTION	PREHEAT.	TEMPERATURE (°C)	COOK TIME (Min.)	LEVEL AND ACCESSORIES
Leavened cakes / Sponge cakes		-	170	30 - 50	2 
		Yes	160	30 - 50	2 
		Yes	160	30 - 50	4 1  
Filled cakes (cheesecake, strudel, apple pie)		-	160 - 200	30 - 85	3 
		Yes	160 - 200	35 - 90	4 1  
Cookies / Small cakes		-	160 - 170	20 - 40	3 
		Yes	150 - 160	20 - 40	3 
		Yes	150 - 160	20 - 40	4 1  
Choux buns		-	180 - 200	30 - 40	3 
		Yes	180 - 190	35 - 45	4 1  
		Yes	180 - 190	35 - 45*	5 3 1   
Meringues		Yes	90	110 - 150	3 
		Yes	90	130 - 150	4 1  
		Yes	90	140 - 160*	5 3 1   
Pizza (Thin, thick, focaccia)		-	220 - 250	20 - 40	2 
		Yes	220 - 240	20 - 40	4 1  
		Yes	220 - 240	25 - 50*	5 3 1   
Bread loaf 0,5 kg		-	180 - 220	50 - 70	2 
Small bread		-	180 - 220	30 - 50	3 
Bread		Yes	180 - 220	30 - 60	4 1  
Frozen pizza		-	250	10 - 20	2 
		Yes	250	10 - 20	4 1  
Savoury pies (vegetable pie, quiche)		Yes	180 - 190	45 - 60	2 
		Yes	180 - 190	45 - 60	4 1  
		Yes	180 - 190	45 - 70*	5 3 1   
Vols-au-vent / Puff pastry crackers		Yes	190 - 200	20 - 30	3 
		Yes	180 - 190	20 - 40	4 1  
		Yes	180 - 190	20 - 40*	5 3 1   
Lasagne / Flans		-	190 - 200	40 - 65	3 
Baked pasta / Cannelloni		-	190 - 200	25 - 45	3 

RECIPE	FUNCTION	PREHEAT.	TEMPERATURE (°C)	COOK TIME (Min.)	LEVEL AND ACCESSORIES
Lamb / Veal / Beef / Pork 1 kg		-	190 - 200	60 - 90	3
Roast pork with crackling 2 kg		-	170	110 - 150	2
Chicken / Rabbit / Duck 1 kg		-	200 - 230	50 - 80 **	3
Turkey / Goose 3 kg		-	190 - 200	90 - 150	2
Baked fish / en papillote (fillets, whole)		Yes	180 - 200	40 - 60	3
Stuffed vegetables (tomatoes, courgettes, aubergines)		Yes	180 - 200	50 - 60	2
Toast		-	3 (High)	3 - 6	5
Fish fillets / Steaks		-	2 (Mid)	20 - 30***	4 3
Sausages / Kebabs / Spare ribs / Hamburgers		-	2 - 3 (Mid - High)	15 - 30***	5 4
Roast chicken 1-1,3 kg		-	2 (Mid)	55 - 70**	2 1
Roast beef rare 1 kg		-	2 (Mid)	35 - 50**	3
Leg of lamb / Shanks		-	2 (Mid)	60 - 90**	3
Roast potatoes		-	2 (Mid)	35 - 55**	3
Vegetable gratin		-	3 (High)	10 - 25	3
Complete meal: Fruit tart (level 5)/ lasagne (level 3)/meat (level 1)		Yes	190	40 - 120*	5 3 1
Lasagna & Meat		Yes	200	50 - 120*	4 1
Meat & Potatoes		Yes	200	45 - 120*	4 1
Fish & Vegetables		Yes	180	30 - 50	4 1
Stuffed roasting joints		-	200	80 - 120*	3
Cuts of meat (rabbit, chicken, lamb)		-	200	50 - 120*	3

* Estimated length of time: dishes can be removed from the oven at different times depending on personal preference.
 ** Turn food two thirds of the way through cooking (if necessary).
 *** Turn food halfway through cooking.

Please note: 6th Sense "Pastry Cakes" function uses upper and lower heating elements only, without forced air circulation. It doesn't require preheating.

FUNCTIONS	Conventional	Grill	Turbo Grill	Forced Air	Convection Bake	Eco Forced Air
AUTOMATIC FUNCTIONS	Casserole	Meat	Maxi Cooking	Bread	Pizza	Pastry cakes
ACCESSORIES	Wire shelf	Oven tray or cake tin on wire shelf	Drip tray / Baking tray or oven tray on wire shelf	Drip tray / Baking tray	Drip tray with 500 ml of water	

MAINTENANCE AND CLEANING

Make sure that the oven has cooled down before carrying out any maintenance or cleaning.

Do not use steam cleaners.

Do not use wire wool, abrasive scourers or abrasive/corrosive cleaning agents, as these could damage the surfaces of the appliance.

Wear protective gloves.

The oven must be disconnected from the mains before carrying out any kind of maintenance work.

EXTERIOR SURFACES

- Clean the surfaces with a damp microfibre cloth. If they are very dirty, add a few drops of pH-neutral detergent. Finish off with a dry cloth.
- Do not use corrosive or abrasive detergents. If any of these products inadvertently comes into contact with the surfaces of the appliance, clean immediately with a damp microfibre cloth.

INTERIOR SURFACES

- After every use, leave the oven to cool and then clean it, preferably while it is still warm, to remove any deposits or stains caused by food residues. To dry any condensation that has formed as a result of cooking foods with a high water content, let the oven to cool completely and then wipe it with a cloth or sponge.

- Clean the glass in the door with a suitable liquid detergent.
- Activate the "Smart Clean" function for optimum cleaning of the internal surfaces (if present).
- The oven door can be removed to facilitate cleaning.
- The top heating element of the grill can be lowered to clean the upper panel of the oven.

ACCESSORIES

Soak the accessories in a washing-up liquid solution after use, handling them with oven gloves if they are still hot. Food residues can be removed using a washing-up brush or a sponge.

CLEANING THE CATALYTIC PANELS

(ONLY IN SOME MODELS)

This oven is equipped with special catalytic panels that facilitate cleaning of the cooking compartment thanks to their special self-cleaning coating, which is highly porous and able to absorb grease and grime. These panels are fitted to the shelf guides: When repositioning and then refitting the shelf guides, make sure that the hooks at the top are slotted into the appropriate holes in the panels.

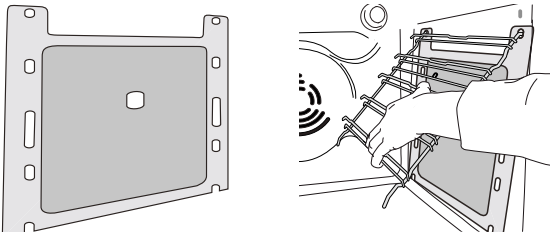

To make best use of the catalytic panels' self-cleaning properties, we recommend heating the oven to 200 °C for around one hour using the "Convection Bake" function. The oven must be empty during this time. Then leave the appliance to cool down before removing any remaining food residues using a non-abrasive sponge.

Please note: Using corrosive or abrasive cleaning agents, stiff brushes, pan scourers or oven sprays could damage the catalytic surface and compromise its self-cleaning properties.

Please contact our After-sales Service if you require replacement panels.

REPLACING THE LIGHT

1. Disconnect the oven from the power supply.
2. Unscrew the cover from the light, replace the bulb and screw the cover back on the light.
3. Reconnect the oven to the power supply.

Please note: Only use 20-40 W/230 ~ V type G9, T300°C halogen bulbs. The bulb used in the product is specifically designed for domestic appliances and is not suitable for general room lighting within the home (EC Regulation 244/2009). Light bulbs are available from our After-sales Service.

- If using halogen bulbs, do not handle them with your bare hands as your fingerprints could cause damage. Do not use the oven until the light cover has been refitted. This product contains a light source of energy efficiency class G.

LOWER THE TOP HEATING ELEMENT

(ONLY IN SOME MODELS)

1. Remove the lateral shelf guides.

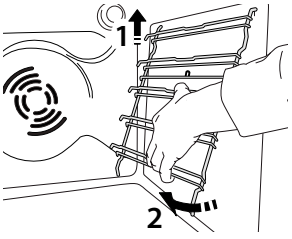

2. Pull the heating element out a little and lower it.

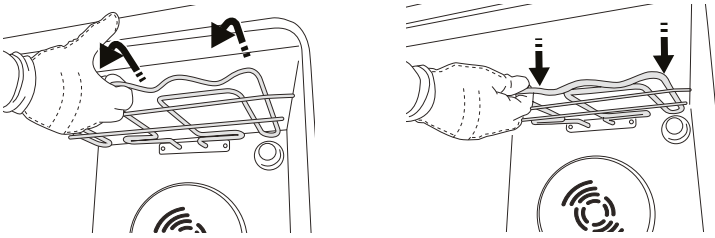

3. To reposition the heating element, lift it up, pulling it slightly towards you, making sure it comes to rest on the lateral supports.

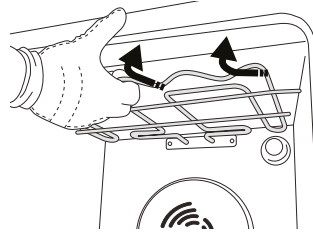

REMOVING AND REFITTING THE DOOR

1. To remove the door, open it fully and lower the catches until they are in the unlock position.

2. Close the door as much as you can. Take a firm hold of the door with both hands – do not hold it by the handle.

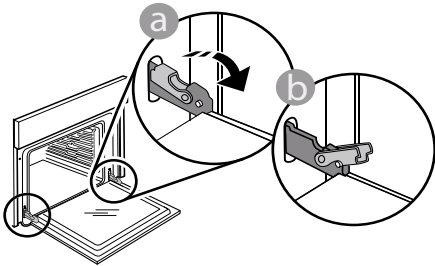

Simply remove the door by continuing to close it while pulling it upwards at the same time until it is released from its seating. Put the door to one side, resting it on a soft surface.

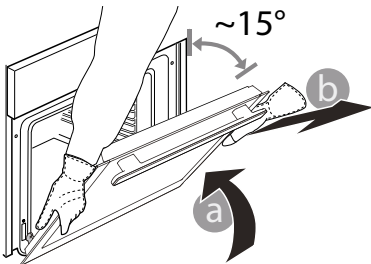

3. Refit the door by moving it towards the oven, aligning the hooks of the hinges with their seating and securing the upper part onto its seating.

4. Lower the door and then open it fully.

Lower the catches into their original position: Make sure that you lower them down completely.

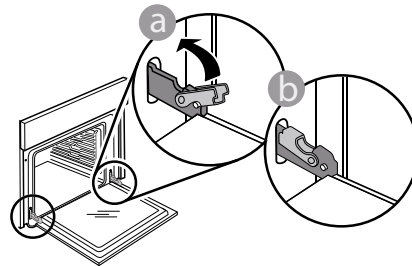

Apply gentle pressure to check that the catches are in the correct position.

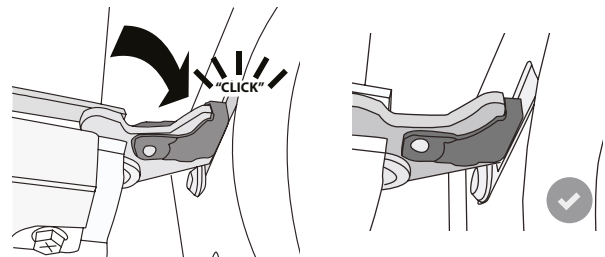

5. Try closing the door and check to make sure that it lines up with the control panel. If it does not, repeat the steps above: The door could become damaged if it does not work properly.

TROUBLESHOOTING

Problem	Possible cause	Solution
The oven is not working.	Power cut. Disconnection from the mains.	Check for the presence of mains electrical power and whether the oven is connected to the electricity supply. Turn off the oven and restart it to see if the fault persists.
The display shows the letter "F" followed by a number or letter.	Software problem.	Contact you nearest Client After-sales Service Centre and state the number following the letter "F".
The display shows unclear text and appears to be broken.	Another language set.	Contact you nearest Client After-sales Service

PRODUCT FICHE

 www.docs.whirlpool.eu The product fiche with energy data of this appliance can be downloaded from Whirlpool website docs.whirlpool.eu

HOW TO OBTAIN THE USE AND CARE GUIDE

>  www.docs.whirlpool.eu Download the Use and Care Guide from our website docs.whirlpool.eu (you can use this QR Code), specifying the product's commercial code.



> Alternatively, contact our Client After-sales Service.

CONTACTING OUR AFTER-SALES SERVICE

You can find our contact details in the warranty manual. When contacting our Client After-sales Service, please state the codes provided on your product's identification plate.

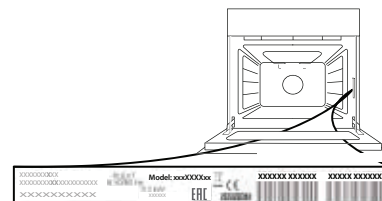

CONSIGNES DE SÉCURITÉ

Avant d'utiliser l'appareil, lire attentivement les consignes de sécurité. Conservez-les à portée pour consultation ultérieure.

Le présent manuel et l'appareil en question contiennent des consignes de sécurité importantes qui doivent être observées en tout temps. Le Fabricant décline toute responsabilité si les consignes de sécurité ne sont pas respectées, en cas de mauvaise utilisation de l'appareil, ou d'un mauvais réglage des commandes.

⚠ Les enfants en bas âge (0-3 ans) doivent être tenus à l'écart de l'appareil. Les jeunes enfants (3-8 ans) doivent être tenus à l'écart de l'appareil sauf s'ils se trouvent sous surveillance constante. Les enfants âgés de 8 ans et plus, ainsi que les personnes présentant des capacités physiques, sensorielles ou mentales réduites, ou ne possédant ni l'expérience ni les connaissances requises, peuvent utiliser cet appareil seulement s'ils sont supervisés, ou si une personne responsable leur a expliqué l'utilisation sécuritaire et les dangers potentiels de l'appareil. Ne laissez pas les enfants jouer avec l'appareil. Le nettoyage et l'entretien ne doivent pas être exécutés par des enfants sans surveillance.

⚠ **AVERTISSEMENT** : L'appareil, ainsi que ses parties accessibles, peuvent atteindre température élevée lors de l'utilisation. Évitez tout contact avec les résistances. Les enfants de moins de 8 ans doivent être tenus à l'écart de l'appareil, à moins d'être sous surveillance constante.

⚠ Ne laissez jamais l'appareil sans surveillance pendant le séchage des aliments. Si une sonde peut être utilisée avec l'appareil, utilisez uniquement la sonde de température recommandée pour ce four - un incendie pourrait se déclarer.

⚠ Gardez les vêtements et autres matières inflammables loin de l'appareil jusqu'à ce que toutes les composantes soient complètement refroidies - un incendie pourrait se déclarer. Soyez toujours vigilant lorsque vous faites la cuisson avec des aliments riches en matière grasse, huile, ou lorsque vous ajoutez de l'alcool - un incendie pourrait se déclarer. Utilisez des gants pour retirer les plats et les accessoires. À la fin de la cuisson, ouvrir la porte avec soin pour permettre à l'air chaud ou la vapeur d'évacuer graduellement avec d'accéder la cavité - vous pourriez vous brûler. Évitez d'obstruer les événements d'air chaud à l'avant du four - un incendie pourrait se déclarer.

⚠ Prenez garde de ne pas entrer en collision avec la porte du four lorsque qu'elle est ouverte ou en position abaissée.

IMPORTANT - À LIRE ET À RESPECTER

USAGE AUTORISÉ

⚠ **MISE EN GARDE** : Cet appareil n'est pas conçu pour être utilisé avec un dispositif de mise en marche externe comme une minuterie ou un système de contrôle à distance.

⚠ Cet appareil est destiné à un usage domestique et peut aussi être utilisé dans les endroits suivants : cuisines pour le personnel dans les magasins, bureaux et autres environnements de travail ; dans les fermes ; par les clients dans les hôtels, motels, et autres résidences similaires.

⚠ Aucune autre utilisation n'est autorisée (p. ex. pour chauffer des pièces).

⚠ Cet appareil n'est pas conçu pour un usage professionnel. N'utilisez pas l'appareil en extérieur.

⚠ N'entreposez pas de substances explosives ou inflammables (p. ex. essence ou bombe aérosol) à l'intérieur ou près de l'appareil - un incendie pourrait se déclarer.

INSTALLATION

⚠ Deux personnes minimum sont nécessaires pour déplacer et installer l'appareil - risque de blessure. Utilisez des gants de protection pour le déballage et l'installation de l'appareil - vous risquez de vous couper.

⚠ L'installation, incluant l'alimentation en eau (selon le modèle), et les connexions électriques, ainsi que les réparations, doivent être exécutées par un technicien qualifié. Ne procédez à aucune réparation ni à aucun remplacement de pièce sur l'appareil autres que ceux spécifiquement indiqués dans le guide d'utilisation. Gardez les enfants à l'écart du site d'installation. Après avoir déballé l'appareil, assurez-vous qu'il n'a pas été endommagé pendant le transport. En cas de problème, contactez votre revendeur ou le Service Après-Vente le plus proche. Une fois installé, gardez le matériel d'emballage (sacs en plastique, parties en polystyrène, etc.) hors de la portée des enfants - ils pourraient s'étouffer. L'appareil ne doit pas être branché à l'alimentation électrique lors de l'installation - vous pourriez vous électrocuter. Au moment de l'installation, assurez-vous que le câble d'alimentation n'est pas endommagé par l'appareil - risque d'incendie ou de choc électrique. Allumez l'appareil uniquement lorsque l'installation est terminée.

⚠ Découpez le contour du meuble avant d'y insérer l'appareil, et enlevez soigneusement tous les copeaux et la sciure de bois.

N'obstruez pas l'espace minimum entre le plan de travail et le rebord supérieur du four - vous pourriez vous brûler.

Retirer le four de sa base en mousse de polystyrène uniquement au moment de l'installation.

⚠ Une fois l'installation terminée, l'accès à la partie inférieure de l'appareil doit être impossible - vous pourriez vous brûler.

⚠ Ne pas installer l'appareil derrière une porte décorative - un incendie pourrait se déclarer.

ALIMENTATION ÉLECTRIQUE

⚠ La plaque signalétique se trouve sur le rebord avant du four (visible lorsque la porte est ouverte).

⚠ Il doit être possible de débrancher l'appareil de l'alimentation électrique en retirant la fiche de la prise de courant si elle est accessible, ou à l'aide d'un interrupteur multipolaire en amont de la prise de courant, conformément aux normes de sécurité électrique nationales.

⚠ Utilisez pas de rallonge, de prises multiples ou d'adaptateurs. Une fois l'installation terminée, l'utilisateur ne devra plus pouvoir accéder aux composants électriques. N'utilisez pas l'appareil si vous êtes mouillé ou si vous êtes pieds nus. N'utilisez pas l'appareil si le câble d'alimentation ou la prise de courant est endommagé(e), si l'appareil ne fonctionne pas correctement, ou s'il a été endommagé ou est tombé.

⚠ Si le câble d'alimentation est endommagé, il doit être remplacé avec un câble identique par le fabricant, un représentant du Service Après-vente, ou par toute autre personne qualifiée - vous pourriez vous électrocuter.

⚠ Si le câble d'alimentation doit être remplacé, contactez un Service Après-vente agréé.

NETTOYAGE ET ENTRETIEN

⚠ AVERTISSEMENT : Assurez-vous que l'appareil est éteint et débranchez de l'alimentation électrique avant d'effectuer le nettoyage ou l'entretien ; n'utilisez jamais un appareil de nettoyage à vapeur - risque de choc électrique.

⚠ N'utilisez pas de produits abrasifs ou de grattoirs métalliques tranchants pour nettoyer la vitre de la porte, ils peuvent égratigner la surface et, à la longue, briser le verre.

⚠ Laissez refroidir l'appareil avant de le nettoyer ou effectuer l'entretien - vous pourriez vous brûler.

⚠ AVERTISSEMENT : Éteindre l'appareil avant de remplacer l'ampoule- vous pourriez vous électrocuter.

MISE AU REBUT DES MATÉRIAUX D'EMBALLAGE

Les matériaux d'emballage sont entièrement recyclables comme l'indique le symbole de recyclage ♻.

Les différentes parties de l'emballage doivent donc être jetées de manière responsable et en totale conformité avec les réglementations des autorités locales régissant la mise au rebut de déchets.

MISE AU REBUT DES APPAREILS ÉLECTROMÉNAGERS

Cet appareil est fabriqué à partir de matériaux recyclables ou réutilisables. Mettez-le au rebut en vous conformant aux réglementations locales en matière d'élimination des déchets. Pour toute information supplémentaire sur le traitement et le recyclage des appareils électroménagers, contactez le service local compétent, le service de collecte des déchets ménagers ou le magasin où vous avez acheté l'appareil. Cet appareil est marqué comme étant conforme à la Directive européenne 2012/19/EU, aux réglementations relatives aux Déchets d'équipement électrique et électronique (DEEE) et relatives aux Déchets d'équipement électrique et électronique de 2013 (tels qu'amendés).

En vous assurant que l'appareil est mis au rebut correctement, vous pouvez aider à éviter d'éventuelles conséquences négatives sur l'environnement et la santé humaine.

Le symbole  sur le produit ou sur la documentation qui l'accompagne indique qu'il ne doit pas être traité comme un déchet domestique, mais doit être remis à un centre de collecte spécialisé pour le recyclage des appareils électriques et électroniques.

CONSEILS RELATIFS À L'ÉCONOMIE D'ÉNERGIE

Préchauffez le four uniquement si le tableau de cuisson ou votre recette le demande. Utilisez des plaques de cuisson foncées, laquées ou émaillées, car ils absorbent mieux la chaleur. Les aliments nécessitant un temps de cuisson plus long continueront à cuire même si le four est éteint.

DÉCLARATION D'ÉCOCONCEPTION

Cet appareil respecte les normes suivantes : Conditions requises d'écoconception de la Réglementation européenne 66/2014 ; Réglementation en matière de Label énergétique 65/2014 ; Réglementations en matière d'écoconception pour les produits liés à l'énergie et les informations énergétiques (Amendement) (Sortie de l'UE) 2019, conformément à la norme européenne EN 60350-1.

GUIDE D'UTILISATION QUOTIDIENNE



MERCI D'AVOIR ACHETÉ UN PRODUIT WHIRLPOOL

Afin de bénéficier d'une aide et d'un support plus approfondi, veuillez enregistrer votre produit sur www.whirlpool.eu/register



Vous pouvez télécharger les Consignes de sécurité et le Guide d'utilisation et d'entretien en visitant notre site Web docs.whirlpool.eu et en suivant les consignes au dos de ce livret.

! Lire attentivement les Consignes de santé et de sécurité avant d'utiliser l'appareil.

DESCRIPTION DU PRODUIT

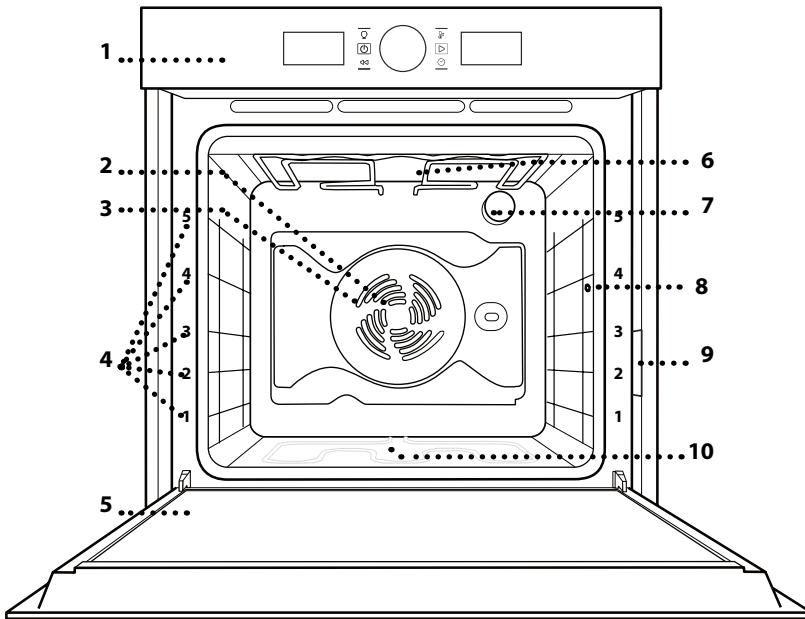

1. PANNEAU DE COMMANDE
2. Ventilateur
3. Élément chauffant circulaire (invisible)
4. Supports de grille (le niveau est indiqué à l'avant du four)
5. Porte
6. Élément chauffant supérieur/gril
7. Lampe
8. Point d'insertion de la sonde à viande (le cas échéant)
9. Plaque signalétique (ne pas enlever)
10. Élément chauffant inférieur (invisible)

PANNEAU DE COMMANDE

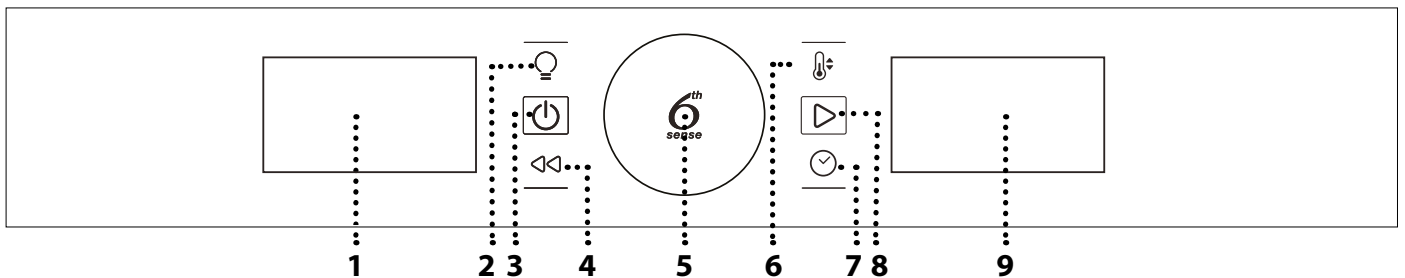

1. ÉCRAN AFFICHAGE GAUCHE

2. ÉCLAIRAGE

Pour allumer/éteindre l'ampoule.

3. ON/OFF

Pour allumer ou éteindre le four, et pour interrompre une fonction.

4. RETOUR

Pour retourner au menu précédent lors de la configuration des réglages.

5. BOUTON ROTATIF / BOUTON 6TH SENSE

Tournez pour sélectionner les fonctions et régler tous les paramètres de cuisson. Appuyer sur  pour sélectionner, régler, accéder ou confirmer des fonctions ou paramètres et éventuellement démarrer le programme de cuisson.

6. TEMPÉRATURE

Pour régler la température.

7. HEURE

Pour régler ou changer le temps, et régler le temps de cuisson.

8. DÉBUT

Pour lancer les fonctions et confirmer les réglages.

9. ÉCRAN AFFICHAGE DROIT

ACCESSOIRES

GRILLE MÉTALLIQUE

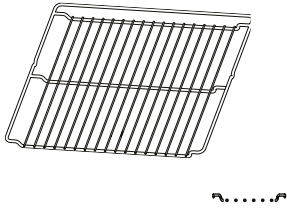

LÈCHEFRITE

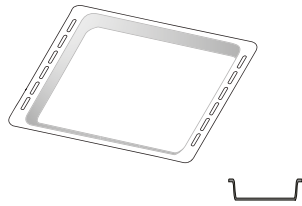

PLAQUE DE CUISSON

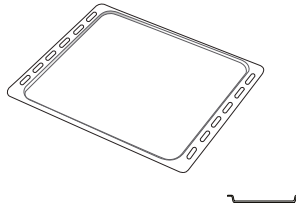

GRILLES COULISSANTES (UNIQUEMENT DANS CERTAINS MODÈLES)

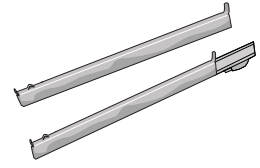

SONDE À VIANDE (UNIQUEMENT SUR CERTAINS MODÈLES)

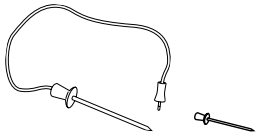

Le nombre d'accessoires peut varier en fonction du modèle acheté.

Il est possible d'acheter séparément d'autres accessoires auprès du Service Après-Vente.

INSÉRER LA GRILLE MÉTALLIQUE ET LES AUTRES ACCESSOIRES

Insérez la grille métallique horizontalement en la glissant sur les supports de grille, assurez-vous que le côté avec le bord relevé est placé vers le haut.

Les autres accessoires, comme la lèchefrite et la plaque de cuisson, sont insérés à l'horizontal, de la même manière que la grille métallique.

INSTALLER LES GRILLES COULISSANTES

(SELON LE MODÈLE)

Enlevez les supports de grille du four et enlevez la protection de plastique des grilles coulissantes.

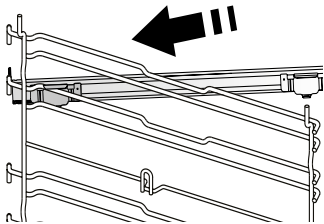

Attachez l'agrafe supérieure de la grille coulissante au support de grille et glissez-la aussi loin que possible. Abaissez l'autre agrafe en place.

Pour fixer le guide, pressez la partie inférieure de l'agrafe fermement sur le support de grille. Assurez-vous que les grilles ne bougent pas. Répétez ces étapes pour l'autre support de grille du même niveau.

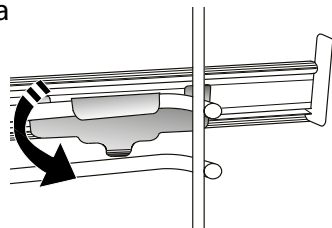

Veillez noter : Les grilles coulissantes peuvent être installées au niveau de votre choix.

ENLEVER ET REPLACER LES SUPPORTS DE GRILLE

Consultez les photos pour enlever les supports latéraux et (le cas échéant) les écrous de la cavité qui les maintiennent.

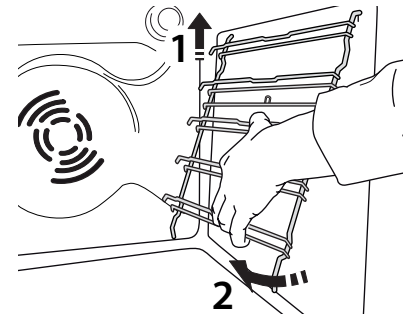
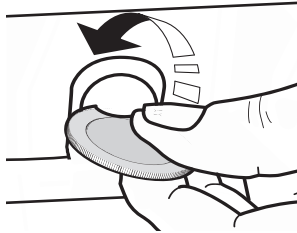
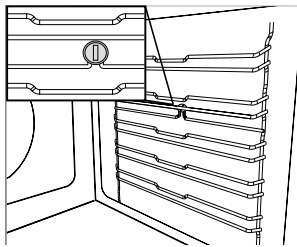

Pour remplacer les supports de grille, vous devez en premier les replacer dans leur appui supérieur. En les maintenant soulevés, glissez-les dans le compartiment de cuisson, abaissez-les ensuite dans leur appui inférieur.

FONCTIONS



CONVECTION NATURELLE

Pour cuire tout type de plat sur une seule grille.



GRIL

Pour cuire des biftecks, des brochettes, et des saucisses, faire gratiner des légumes et griller du pain. Pour la cuisson de la viande, nous vous conseillons d'utiliser une lèchefrite pour recueillir les jus de cuisson : Placez la lèchefrite, contenant 500 ml d'eau, sur n'importe quel niveau sous la grille métallique.



CHALEUR PULSÉE

Pour cuire différents aliments demandant la même température de cuisson sur plusieurs grilles (maximum de trois) en même temps. Cette fonction permet de cuire différents aliments sans transmettre les odeurs d'un aliment à l'autre.



CONVECTION FORCÉE

Pour la cuisson de la viande, les gâteaux avec garniture, ou des rôtis farcis aux légumes sur un seul niveau. Cette fonction utilise une circulation d'air délicate et intermittente pour éviter que les aliments ne s'assèchent trop.



FONCTIONS 6TH SENSE



RAGOÛT

Cette fonction sélectionne automatiquement la meilleure température et la meilleure méthode de cuisson pour les pâtes.



VIANDES

Cette fonction sélectionne automatiquement la meilleure température et la meilleure méthode de cuisson pour la viande. Cette fonction active de façon intermittente le ventilateur à basse vitesse pour empêcher les aliments de trop sécher.



CUISSON GROSSE PIÈCE

La fonction sélectionne automatiquement le meilleur mode de cuisson et la température pour cuire de grosses pièces de viande (de plus de 2,5 kg). Il est conseillé de retourner la viande pendant la cuisson pour obtenir un dorage homogène des deux côtés. Arrosez de temps à autre la viande avec son jus de cuisson pour éviter son dessèchement.



PAIN

Cette fonction sélectionne automatiquement la meilleure température et la meilleure méthode de cuisson pour tous les types de pain.



PIZZA

Cette fonction sélectionne automatiquement la meilleure température et la meilleure méthode de cuisson pour tous les types de pizza.



GÂTEAUX

Cette fonction sélectionne automatiquement la meilleure température et la meilleure méthode de cuisson pour tous les types de gâteau.



FONCTIONS SPÉCIALES



PRÉCHAUFFAGE RAPIDE

Pour préchauffer le four rapidement. Une fois la phase de préchauffage terminée, le four va automatiquement sélectionner la fonction « Traditionnelle ». Attendre la fin du préchauffage avant d'y placer les aliments.



TURBO GRILL

Pour griller de gros morceaux de viande (gigots, rôtis, poulets). Nous vous conseillons d'utiliser une lèchefrite pour recueillir les jus de cuisson : Placez la lèchefrite, contenant 500 ml d'eau, sur n'importe quel niveau sous la grille. Le tournebroche (selon le modèle) peut être utilisé avec cette fonction.



ÉCO CHALEUR PULSÉE*

Pour cuire les rôtis farcis et les filets de viande sur une seule grille. Les aliments ne s'assèchent pas trop grâce à une légère circulation d'air intermittente. Lorsque cette fonction ÉCO est utilisée, le voyant reste éteint pendant la cuisson. Pour utiliser le cycle ÉCO et ainsi optimiser la consommation d'énergie, la porte du four ne devrait pas être ouverte avant la fin de la cuisson.



MAINTIEN AU CHAUD

Pour conserver les aliments cuits chauds et croustillants.



LEVAGE DE LA PÂTE

Pour un levage parfait des pâtes sucrées ou salées. Pour assurer la qualité de levage, n'activez pas la fonction si le four est encore chaud après un cycle de cuisson.



SMART CLEAN

(UNIQUEMENT SUR CERTAINS MODÈLES)

L'action de la vapeur créée lors de ce cycle de nettoyage à basse température spécial permet d'enlever la saleté et les résidus d'aliments plus facilement. Placez 200 ml d'eau potable au fond de la cavité et lancez la fonction lorsque le four est froid.

* Fonction utilisée comme référence pour la déclaration d'efficacité énergétique conformément au Règlement (UE) n° 65/2014

UTILISER L'APPAREIL POUR LA PREMIÈRE FOIS

1. RÉGLER L'HEURE

Vous devez régler l'heure lorsque vous allumez l'appareil pour la première fois.



Les deux chiffres de l'heure clignotent : Tournez le bouton pour régler l'heure et appuyez sur  pour confirmer.



Les deux chiffres des minutes clignotent. Tournez le bouton pour régler les minutes et appuyez sur  pour confirmer.

Veillez noter: Pour changer l'heure plus tard, appuyez sur  pour au moins une seconde alors que le four est éteint, et répétez les étapes décrites plus haut.

Vous pourriez avoir à régler l'heure à la suite d'une panne de courant prolongée.

2. RÉGLAGES

Au besoin, vous pouvez changer les unités de mesure par défaut, la température (°C), et le courant nominal (16 A).

Avec le four éteint, appuyez sur  pour au moins 5 secondes.



Tournez le bouton de sélection pour sélectionner l'unité de mesure, appuyez ensuite sur  pour confirmer.



Tournez le bouton de sélection pour sélectionner le courant nominal, appuyez ensuite sur  pour confirmer.

Veillez noter: Le four est programmé pour consommer un niveau d'énergie électrique compatible avec un réseau domestique supérieur à 3 kW (16A) : Si votre résidence utilise un niveau d'énergie plus bas, vous devrez diminuer la valeur (13A).

3. CHAUFFER LE FOUR

Un nouveau four peut dégager des odeurs provenant de la fabrication : ceci est parfaitement normale.

Avant de cuire des aliments, nous vous conseillons de chauffer le four à vide pour éliminer les odeurs.

Enlever les cartons de protection ou les pellicules transparentes du four, et enlever les accessoires qui se trouvent à l'intérieur.

Chauffer le four à 200 °C pour environ une heure, de préférence utilisant une fonction avec circulation d'air (p. ex. « Chaleur pulsée » ou « Convection forcée »). Suivez les directives pour régler correctement la fonction.

Veillez noter : Nous vous conseillons d'aérer la pièce après avoir utilisé l'appareil pour la première fois.

UTILISATION QUOTIDIENNE

1. SÉLECTIONNER UNE FONCTION

Lorsque le four est éteint, seul l'heure est affichée à l'écran. Appuyez sur  pour allumer le four.

Tournez le bouton pour afficher les principales fonctions disponibles sur l'écran de gauche.

Sélectionnez une fonction et appuyez sur .

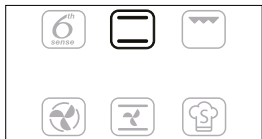

Pour sélectionner une sous-fonction (selon le modèle), sélectionnez la fonction principale et appuyez ensuite sur  pour confirmer et accéder au menu de la fonction.



Tournez le bouton pour afficher les sous-fonctions disponibles sur l'écran de droite. Sélectionnez une fonction et appuyez sur  pour confirmer.

2. RÉGLER UNE FONCTION

Après avoir sélectionné la fonction désirée, vous pouvez changer les réglages.

L'écran affiche en séquence les réglages qui peuvent être changés.

TEMPÉRATURE/NIVEAU DE LA GRILLE



Lorsque le voyant °C/°F clignote à l'écran, tournez le bouton pour changer la valeur, appuyez ensuite sur  pour confirmer et modifier les réglages suivants (lorsque possible).

Vous pouvez aussi régler le niveau du grill (3 = élevé, 2 = normal, 1 = bas) en même temps.



Veillez noter : Une fois la fonction en cours, vous pouvez changer la température ou le niveau du grill en appuyant sur ou simplement en tournant le bouton.

DURÉE

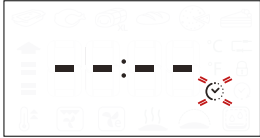

Lorsque le voyant clignote à l'écran, utilisez le bouton de réglage pour régler le temps de cuisson désiré, et appuyez ensuite sur pour confirmer.

Vous n'avez pas à régler le temps de cuisson si vous avez l'intention de gérer la cuisson manuellement : Appuyer sur pour confirmer et lancer la fonction. Dans ce cas, vous ne pouvez pas régler la fin de la cuisson en programmant un départ différé.

Veillez noter: Vous pouvez ajuster le temps de cuisson en cours de cuisson en appuyant sur : Tournez le bouton pour régler l'heure et appuyez sur pour confirmer.

RÉGLAGE DE L'HEURE DE FIN DE CUISSON / DÉPART DIFFÉRÉ

Pour plusieurs fonctions, une fois que vous avez réglé le temps de cuisson, vous pouvez retarder le démarrage de la fonction en programmant l'heure de fin de cuisson.

Lorsque vous pouvez changer le temps de fin de cuisson, l'écran affiche l'heure prévue de la fin de la cuisson pour la fonction, et le voyant clignote.



Au besoin, tournez le bouton de réglage pour régler l'heure de fin de cuisson désirée, appuyez ensuite sur pour confirmer et lancez la fonction.

Placez les aliments dans le four et fermez la porte : La fonction démarre automatique après une période de temps déterminée pour que la cuisson se termine au moment désiré.



Veillez noter: La programmation d'un délai pour le début de la cuisson désactive la phase de préchauffage. Le four va atteindre la température désirée graduellement, ce qui signifie que les temps de cuisson vont être légèrement plus longs que ceux indiqués sur le tableau de cuisson.

Pendant la période d'attente, vous pouvez utiliser le bouton pour changer le temps de fin de cuisson programmée.

Appuyez sur ou pour changer la température et le temps de cuisson. Appuyez sur pour confirmer lorsque vous avez terminé.

Veillez noter: Le démarrage différé de la fonctionnalité n'est pas disponible pour les fonctions Grill et Turbo-grill.

3. ACTIVER LA FONCTION

Une fois que vous avez terminé les réglages, appuyez sur pour lancer la fonction.

Vous pouvez appuyer sur à tout moment pour interrompre la fonction en cours.

4. PRÉCHAUFFAGE

Certaines fonctions ont une phase de préchauffage : Une fois la fonction lancée, l'écran confirme que la phase de préchauffage est aussi activée.



Une fois cette phase complétée, un signal sonore et l'écran indiquent que le four a atteint la température désirée.



À ce moment, ouvrez la porte, placez les aliments dans le four, refermez la porte et commencez la cuisson en appuyant sur .

Veillez noter : Placer les aliments dans le four avant que le préchauffage soit terminé peut affecter la cuisson.

La phase de préchauffage sera interrompue si vous ouvrez la porte durant le processus.

Le temps de cuisson ne comprend pas la phase de préchauffage.

Vous pouvez toujours changer la température désirée en utilisant le bouton.

5. FIN DE CUISSON

Un signal sonore et l'écran indiquent la fin de la cuisson.



Pour prolonger le temps de cuisson sans changer les réglages, tournez le bouton pour choisir un nouveau temps de cuisson et appuyez sur .

. FONCTIONS 6th SENSE

RÉTABLISSEMENT DE LA TEMPÉRATURE

Si la température à l'intérieur du four diminue lors du cycle de cuisson à cause de l'ouverture de la porte, une fonction spéciale s'active automatiquement pour rétablir la température initiale.

Pendant que la température se rétablit, l'écran affiche l'image d'un « serpent » jusqu'au rétablissement de la température réglée.

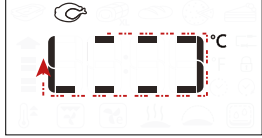



Pendant que le cycle de cuisson programmée est en cours, le temps de cuisson sera réduit en tenant compte le temps pendant lequel la porte a été ouverte dans le but d'obtenir les meilleurs résultats.

. FONCTIONS SPÉCIALES

SMART CLEAN

Pour activer la fonction « Smart Clean », avec le four froid, distribuer 200 ml d'eau sur le fond de la cavité du four, puis fermer la porte du four.

Accédez les fonctions spéciales  et tournez le bouton pour sélectionner  à partir du menu, appuyez ensuite sur  pour confirmer.

Appuyez sur  pour lancer immédiatement le cycle de nettoyage, ou appuyez sur  pour régler l'heure de fin/départ différé.

À la fin du cycle, laissez le four refroidir et enlevez toute l'eau résiduelle dans le four. Nettoyez en utilisant une éponge humidifiée avec de l'eau chaude (le nettoyage pourrait être compromis si vous attendez plus de 15 minutes).

Veillez noter : La durée et la température du cycle de nettoyage ne peuvent pas être réglées

. UTILISATION DE LA SONDE À VIANDE (LE CAS ÉCHÉANT)

La sonde à viande fournie permet de mesurer la température interne exacte des aliments pendant la cuisson.

La sonde à viande est autorisée uniquement dans certaines fonctions de cuisson (Traditionnel, Chaleur pulsée, Convection forcée, Turbo Grill, 6th Sense Viandes et 6th Sense Maxicooking).

Il est très important de bien placer la sonde pour obtenir des résultats de cuisson parfaits. Insérer la sonde totalement dans la partie la plus pulpeuse de la viande, en évitant les os et les parties grasses.

Pour la volaille, la sonde doit être insérée sur les côtés, au milieu de la poitrine, en veillant à ce que le bout de la sonde n'aboutisse pas dans une partie creuse. Si l'épaisseur de la viande est irrégulière, contrôler

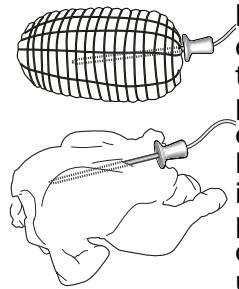

qu'elle est cuite correctement avant de la retirer du four. Brancher l'extrémité de la sonde dans le trou situé sur la paroi droite de la cavité du four.





Quand la sonde à viande est insérée dans la cavité du four, un signal sonore est activé et l'écran présente l'icône et la température à atteindre.

Si la sonde à viande est insérée pendant la sélection d'une fonction, l'écran passe à la température cible par défaut de la sonde à viande.





Appuyez sur  pour démarrer les réglages. Tournez le bouton pour régler la température cible de la sonde à viande. Appuyez sur  pour confirmer. Tournez le bouton pour régler la température de la cavité du four.



Appuyez sur  ou  pour confirmer et démarrez le cycle de cuisson.

Pendant le cycle de cuisson, l'écran affiche la température cible de la sonde à viande. Quand la viande atteint la température cible établie, le cycle de cuisson s'arrête et l'écran affiche « Fin ».

Pour redémarrer le cycle de cuisson à partir de « Fin », en tournant il est possible d'ajuster la température cible du thermomètre cible comme indiqué ci-dessus. Appuyez sur  ou  pour confirmer et redémarrer le cycle de cuisson.

Veillez noter : pendant le cycle de cuisson avec une sonde à viande, il est possible de tourner pour changer la température cible de la sonde à viande. Appuyez sur  pour ajuster la température de la cavité du four.

La sonde à viande peut être insérée à n'importe quel moment, même pendant un cycle de cuisson. Dans ce cas, il est nécessaire de régler de nouveau les paramètres de la fonction de cuisson.

Si la sonde à viande est incompatible avec une fonction, le four éteint le cycle de cuisson et émet un signal sonore d'alerte. Dans ce cas, débrancher la sonde à viande ou appuyez sur  pour régler une autre fonction. Le démarrage différé et la phase de préchauffage ne sont pas compatibles avec la sonde à viande.

. VERROUILLAGE DES TOUCHES

Pour verrouiller les touches, appuyez sur  pour au moins 5 secondes.



Répétez pour déverrouiller le clavier.

Veillez noter: Le verrouillage peut aussi être activé pendant la cuisson.

Pour des raisons de sécurité, la fonction peut être éteinte en tout temps en appuyant sur .

CONSEILS UTILES

COMMENT LIRE LE TABLEAU DE CUISSON

Le tableau indique la meilleure fonction, les accessoires, et le niveau à utiliser pour la cuisson des différents types d'aliments. Les temps de cuisson commencent au moment de l'introduction du plat dans le four et ne tiennent pas compte du préchauffage (s'il est nécessaire). Les températures et temps de cuisson sont approximatifs et dépendent de la quantité d'aliments et du type d'accessoire. Pour commencer, utilisez les valeurs conseillées les plus basses, et si les aliments ne sont pas assez cuits, augmentez-les. Utilisez les accessoires fournis, et de préférence des moules à gâteau en métal foncés et des plats de cuisson. Vous pouvez aussi utiliser des plaques et accessoires en pyrex ou en céramique ; cependant, les temps de cuisson seront sensiblement plus longs.

CUIRE DES ALIMENTS DIFFÉRENTS EN MÊME TEMPS

La fonction « Chaleur pulsée » permet de cuire simultanément plusieurs aliments nécessitant la même température de cuisson (par exemple : poisson et légumes), sur différentes grilles. Enlevez les aliments qui demandent moins de cuisson et laissez dans le four les aliments qui ont besoin de plus de cuisson.

VIANDES

Utilisez tout type de plat à four ou plat en pyrex adapté à la taille du morceau de viande à cuire. Pour les rôtis, il est conseillé d'ajouter du bouillon dans le plat et d'arroser la viande durant la cuisson pour la rendre plus savoureuse. Veuillez noter que de la vapeur est produite durant cette opération. Lorsque le rôti est cuit, laissez-le reposer dans le four 10 à 15 minutes ou enveloppez-le dans du papier aluminium.

Si vous désirez faire griller de la viande, choisissez des morceaux de la même épaisseur pour obtenir une cuisson uniforme. Les morceaux de viande très épais demandent un temps de cuisson plus long. Pour éviter de brûler la viande sur les côtés, abaissez la grille pour éloigner la nourriture du grill. Retournez la viande aux deux tiers de la cuisson. Au moment d'ouvrir la porte, faites attention à la vapeur chaude qui s'échappe.

Nous vous conseillons de placer une lèchefrite avec un demi-litre d'eau directement en dessous de la grille sur laquelle la viande est placée pour recueillir le jus de cuisson. Ajoutez de l'eau si nécessaire.

DESSERTS

Cuire les pâtisseries sur une seule grille avec la fonction convection naturelle.

Utilisez des moules à gâteau en métal foncé et toujours les placer sur la grille métallique disponible. Pour la cuisson sur plusieurs grilles, sélectionnez la fonction Chaleur pulsée et décalez les moules à gâteau sur les grilles de manière à favoriser la circulation de l'air chaud.

Pour contrôler si un gâteau est cuit, introduisez un cure-dent en bois au centre du gâteau. Si le cure-dent en ressort sec, le gâteau est cuit.

Si vous utilisez des moules antiadhésifs, ne beurrez pas les bords; le gâteau pourrait ne pas lever de manière homogène sur les bords.

Si le gâteau « retombe » durant la cuisson, sélectionnez une température inférieure la fois suivante. Vous pouvez également réduire la quantité de liquide ou mélanger la pâte plus délicatement. Pour les desserts avec une garniture moelleuse (comme les gâteaux au fromage ou les tartes aux fruits) utilisez la fonction « Convection forcée ». Si le fond de la tarte est trop humide, descendez la plaque et saupoudrez la base avec de la chapelure ou des biscuits émiettés avant de la garnir.

















































































PIZZA

Graissez légèrement les plaques pour obtenir une pizza avec une pâte croustillante. Répartissez la mozzarella sur la pizza aux deux tiers de la cuisson.

LEVAGE DE LA PÂTE

Il est conseillé de couvrir la pâte avec un linge humide avant de la mettre au four. Avec cette fonction, le temps de levage de la pâte diminuent d'environ un tiers par rapport aux temps de levage à température ambiante (20 - 25 °C). Le temps de levage pour la pizza est d'environ une heure pour une pâte de 1 kg.

TABLEAU DE CUISSON

RECETTE	FONCTION	PRÉCHAUFFER	TEMPÉRATURE (°C)	TEMPS DE CUISSON (Min)	NIVEAU ET ACCESSOIRES
Gâteaux à pâte levée / Manqués		-	170	30 - 50	2 
		Oui	160	30 - 50	2 
		Oui	160	30 - 50	4 1  
Gâteaux fourrés (gâteau au fromage, strudel, tarte aux pommes)		-	160 - 200	30 - 85	3 
		Oui	160 - 200	35 - 90	4 1  
Cookies / Petits gâteaux		-	160 - 170	20 - 40	3 
		Oui	150 - 160	20 - 40	3 
		Oui	150 - 160	20 - 40	4 1  
Chouquettes		-	180 - 200	30 - 40	3 
		Oui	180 - 190	35 - 45	4 1  
		Oui	180 - 190	35 - 45*	5 3 1   
Meringues		Oui	90	110 - 150	3 
		Oui	90	130 - 150	4 1  
		Oui	90	140 - 160*	5 3 1   
Pizza (Mince, épaisse, focaccia)		-	220 - 250	20 - 40	2 
		Oui	220 - 240	20 - 40	4 1  
		Oui	220 - 240	25 - 50*	5 3 1   
Pain 0,5 kg		-	180 - 220	50 - 70	2 
Petit pain		-	180 - 220	30 - 50	3 
Pain		Oui	180 - 220	30 - 60	4 1  
Pizza congelée		-	250	10 - 20	2 
		Oui	250	10 - 20	4 1  
Tourtes (tourte aux légumes, quiche)		Oui	180 - 190	45 - 60	2 
		Oui	180 - 190	45 - 60	4 1  
		Oui	180 - 190	45 - 70*	5 3 1   
Vol-au-vent/Feuilletés		Oui	190 - 200	20 - 30	3 
		Oui	180 - 190	20 - 40	4 1  
		Oui	180 - 190	20 - 40*	5 3 1   
Lasagnes/Flans		-	190 - 200	40 - 65	3 
Pâtes au four/Cannellonis		-	190 - 200	25 - 45	3 

RECETTE	FONCTION	PRÉCHAUFFER	TEMPÉRATURE (°C)	TEMPS DE CUISSON (Min)	NIVEAU ET ACCESSOIRES
Agneau / Veau / Bœuf / Porc 1 kg		-	190 - 200	60 - 90	3
Rôti de porc avec couenne 2 kg		-	170	110 - 150	2
Poulet / Lapin / Canard 1 kg		-	200 - 230	50 - 80 **	3
Dinde / Oie 3 kg		-	190 - 200	90 - 150	2
Poisson au four / en papillote (filet, entier)		Oui	180 - 200	40 - 60	3
Légumes farcis (tomates, courgettes, aubergines)		Oui	180 - 200	50 - 60	2
Rôtie		-	3 (Élevée)	3 - 6	5
Filets de poisson / biftecks		-	2 (Moy)	20 - 30***	4 3
Saucisses / brochettes / côtes levées / hamburgers		-	2 - 3 (Moy – Haute)	15 - 30***	5 4
Poulet rôti 1 - 1,3 kg		-	2 (Moy)	55 - 70**	2 1
Rosbif saignant 1kg		-	2 (Moy)	35 - 50**	3
Cuisse d'agneau / Jarrets		-	2 (Moy)	60 - 90**	3
Pommes de terre rôties		-	2 (Moy)	35 - 55**	3
Gratin de légumes		-	3 (élevée)	10 - 25	3
Repas complet : Tarte aux fruits (niveau 5)/ lasagne (niveau 3)/ viande (niveau 1)		Oui	190	40 - 120*	5 3 1
Lasagnes & Viandes		Oui	200	50 - 120*	4 1
Viandes & Pommes de terre		Oui	200	45 - 120*	4 1
Poisson & légumes		Oui	180	30 - 50	4 1
Rôtis farcis		-	200	80 - 120*	3
Morceaux de viande (lapin, poulet, agneau)		-	200	50 - 120*	3

* Durée approximative : les plats peuvent être retirés du four en tout temps, selon vos préférences personnelles.

** Au besoin, retournez les aliments aux deux tiers de la cuisson.

*** Tourner les aliments à mi-cuisson

Veillez noter : La fonction GÂTEAUX 6th Sense utilise les éléments chauffants supérieur et inférieur uniquement, sans circulation de chaleur pulsée. Elle n'a pas besoin de préchauffage.

FONCTIONS	Convection naturelle	Gril	Turbo Gril	Chaleur pulsée	Convection forcée	Éco Chaleur pulsée
FONCTIONS AUTOMATIQUES	Ragoût	Viandes	Cuisson grosse pièce	Pain	Pizza	Gâteaux
ACCESSOIRES	Grille métallique	Plaque de cuisson ou moule à gâteau sur la grille métallique	Lèchefrite / plaque de cuisson ou plat de cuisson sur la grille métallique	Lèchefrite / Plaque de cuisson	Lèchefrite contenant 500 ml d'eau	

NETTOYAGE ET ENTRETIEN

Assurez-vous que le four ait refroidi avant tout entretien ou nettoyage.

N'utilisez pas de nettoyeur à vapeur.

N'utilisez pas de laine d'acier, de tampons à récurer abrasifs, ou des détergents abrasifs ou corrosifs, ils pourraient endommager les surfaces de l'appareil.

Utilisez des gants de protection. L'appareil doit être débranché de l'alimentation principale avant d'effectuer des travaux d'entretien.

SURFACES EXTÉRIEURES

- Nettoyez les surfaces à l'aide d'un chiffon en microfibre humide. Si elles sont très sales, ajoutez quelques gouttes de détergent à pH neutre. Essuyez avec un chiffon sec.
- N'utilisez pas de détergents corrosifs ou abrasifs. Si l'un de ces produits entre en contact avec des surfaces de l'appareil, nettoyez immédiatement à l'aide d'un chiffon en microfibre humide.

SURFACES INTÉRIEURES

- Après chaque utilisation, laissez le four refroidir et ensuite nettoyez-le, de préférence lorsqu'il est encore tiède, pour enlever les dépôts ou taches laissés par les résidus de nourriture. Pour essuyer la condensation qui s'est formée à la suite de la cuisson d'aliments à haute teneur en eau, laissez le four refroidir complètement, et essuyez-le ensuite avec un linge ou une éponge.

- Nettoyez le verre dans la porte avec un détergent liquide approprié.
- Utilisez la fonction "Smart Clean" pour un meilleur nettoyage des surfaces internes. (le cas échéant).
- La porte du four peut être enlevée pour faciliter le nettoyage.
- L'élément chauffant supérieur du gril peut être baissé pour nettoyer la paroi supérieure du four.

ACCESSOIRES

Faire tremper les accessoires dans de l'eau contenant un détergent à vaisselle après les avoir utilisés ; utilisez des gants de cuisine s'ils sont encore chauds. Utilisez une brosse à vaisselle ou une éponge pour enlever les résidus d'aliments.

NETTOYER LES PANNEAUX CATALYTIQUES

(UNIQUEMENT SUR CERTAINS MODÈLES)

Ce four est équipé d'un revêtement catalytique qui facilite le nettoyage du compartiment de cuisson grâce à son enduit auto-nettoyant qui est hautement poreux et capable d'absorber la graisse et la saleté. Ces panneaux sont ajustés sur les supports de grille : Lorsque vous remplacez et réinstallez les supports de grille, assurez-vous que les crochets du haut sont insérés dans les trous correspondants sur les panneaux.

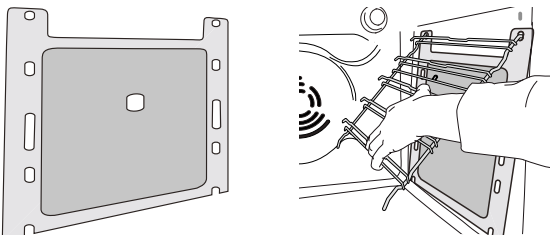

Pour profiter au maximum des propriétés auto-nettoyantes des panneaux catalytiques, nous vous conseillons de chauffer le four à 200 °C pour environ une heure en utilisant la fonction « Convection forcée ». Le four doit être vide durant cette opération. Laissez ensuite le four refroidir avant d'enlever les résidus d'aliments qui restent avec une éponge non abrasive.

Veillez noter : Les produits de nettoyage corrosifs ou abrasifs, les brosses dures, les tampons à récurer, ou les aérosols pour four pourraient endommager la surface catalytique et lui faire perdre ses propriétés auto-nettoyantes.

Veillez contacter notre Service Après-vente si vous avez besoin de panneaux de remplacement.

REMPLENER L'AMPOULE

1. Débranchez le four.
2. Dévissez le couvercle de l'ampoule, remplacez l'ampoule, et revissez le couvercle.
3. Rebranchez le four à l'alimentation électrique.

Veillez noter: Utilisez uniquement des ampoules à halogène de 20- 40W/230 ~ V type G9, T300°C. L'ampoule utilisée dans l'appareil est spécialement conçue pour les appareils électroménagers et ne convient pas pour l'éclairage d'une pièce de la maison (Règlement CE 244/2009). Ces ampoules sont disponibles auprès de notre Service après-vente.

- Ne manipulez pas les ampoules à halogène à mains nues, les traces laissées par vos empreintes pourraient endommager. Avant d'utiliser le four, assurez-vous que le couvercle de l'ampoule a bien été remis en place. Ce produit contient une source lumineuse de classe d'efficacité énergétique G.

ABAISSER L'ÉLÉMENT CHAUFFANT SUPÉRIEUR (UNIQUEMENT SUR CERTAINS MODÈLES)

1. Enlevez les supports de grille latéraux.

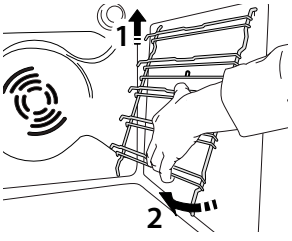

2. Tirez légèrement sur l'élément chauffant et abaissez-le.

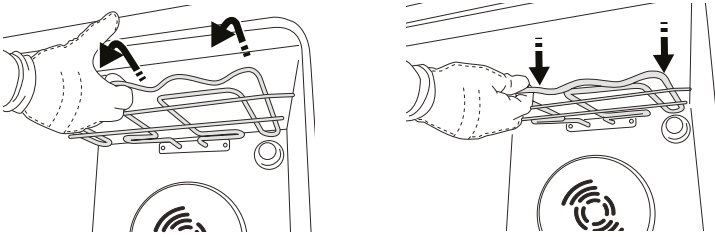

3. Pour remettre l'élément chauffant en place, soulevez-le en le tirant légèrement vers vous. Assurez-vous qu'il repose sur les supports latéraux prévus à cet effet.

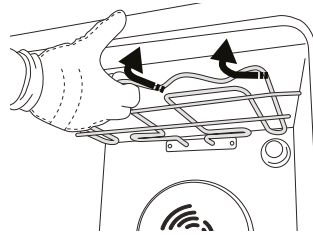

ENLEVER ET RÉINSTALLER LA PORTE

1. Pour enlever la porte, ouvrez-la complètement et abaissez les loquets jusqu'à qu'ils soient déverrouillés.

2. Fermez le plus possible la porte. Tenez la porte fermement avec les deux mains – ne la tenez pas par la poignée.

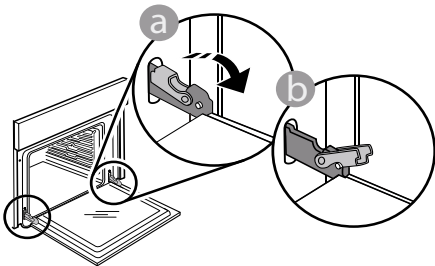

Enlevez simplement la porte en continuant à la fermer tout en la tirant vers le haut jusqu'à ce qu'elle soit dégagée de ses appuis. Placez la porte de côté, l'appuyant sur une surface souple.

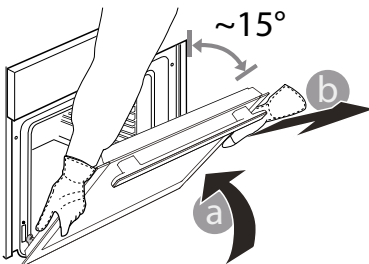

3. Réinstallez la porte en la plaçant devant le four pour aligner les crochets des charnières avec leurs appuis et attacher la partie supérieure sur son appui.

4. Abaissez la porte pour ensuite l'ouvrir complètement.

Abaissez les loquets dans leur position originale : Assurez-vous de les abaisser complètement.

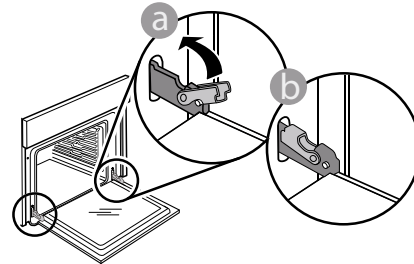

Appliquez une légère pression pour vous assurer que les loquets sont bien placés.

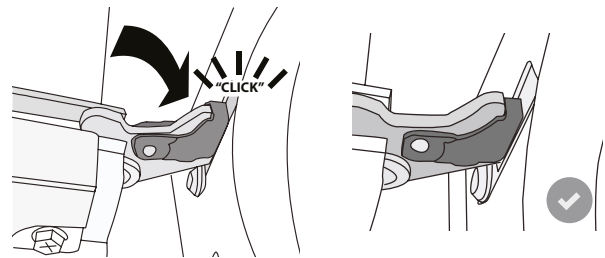

5. Essayez de fermer la porte et assurez-vous qu'elle est alignée avec le panneau de commande. Sinon, répétez les étapes précédentes : La porte pourrait s'endommager si elle ne fonctionne pas correctement.

GUIDE DE DÉPANNAGE

Problème	Cause probable	Solution
Le four ne fonctionne pas.	Coupure de courant. Débranchez de l'alimentation principale.	Assurez-vous qu'il n'y a pas de panne de courant et que le four est bien branché. Éteignez puis rallumez le four pour voir si le problème persiste.
L'écran affiche la lettre « F » suivi d'un numéro ou d'une lettre.	Problème de logiciel.	Prenez en note le numéro qui suit la lettre « F » et contactez le Service Après-vente le plus près.
L'écran indique un texte difficile à lire et semble cassé.	Une autre langue est paramétrée.	Contactez votre Centre de service après-vente le plus proche.

FICHE TECHNIQUE

 www.docs.whirlpool.eu La fiche technique de l'appareil, incluant les taux d'efficacité énergétique, peuvent être téléchargées sur notre site Web Whirlpool docs.whirlpool.eu

COMMENT OBTENIR LE GUIDE D'UTILISATION ET ENTRETIEN

>  www.docs.whirlpool.eu Téléchargez le Guide d'utilisation et d'entretien sur notre site Web docs.whirlpool.eu (vous pouvez utiliser ce code QR), en précisant le code commercial du produit.



> Une autre façon est de contacter notre Service Après-vente.

CONTACTER LE SERVICE APRÈS-VENTE

Vous pouvez trouver les informations pour nous contacter dans le livret de garantie. Lorsque vous contactez notre Service Après-vente, veuillez indiquer les codes disponibles sur la plaque signalétique de l'appareil.

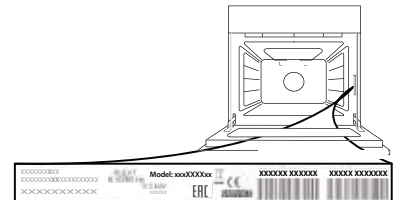

NORME DI SICUREZZA

Prima di utilizzare l'apparecchio, leggere le seguenti norme di sicurezza. Conservarle per eventuali consultazioni successive.

Queste istruzioni e l'apparecchio sono corredati da importanti avvertenze di sicurezza, da leggere e osservare sempre. Il fabbricante declina qualsiasi responsabilità che derivi dalla mancata osservanza delle presenti istruzioni di sicurezza, da usi impropri dell'apparecchio o da errate impostazioni dei comandi.

⚠ Tenere i bambini di età inferiore a 3 anni lontani dall'apparecchio. Senza la sorveglianza costante di un adulto tenere anche l'apparecchio fuori dalla portata dei bambini di età compresa tra 3 e 8 anni. I bambini di età superiore agli 8 anni, le persone con ridotte capacità fisiche, sensoriali o mentali e le persone che non abbiano esperienza o conoscenza dell'apparecchio potranno utilizzarlo solo sotto sorveglianza, o quando siano state istruite sull'utilizzo sicuro dell'apparecchio e siano consapevoli dei rischi del suo utilizzo. I bambini non devono giocare con l'apparecchio. I bambini non devono eseguire operazioni di pulizia e manutenzione dell'apparecchio senza la sorveglianza di un adulto.

⚠ **AVVERTENZA:** L'apparecchio e i suoi componenti accessibili possono diventare molto caldi durante l'uso. Fare attenzione a non toccare le resistenze. Tenere lontani i bambini di età inferiore agli 8 anni, a meno che non siano costantemente sorvegliati.

⚠ Non lasciare mai l'apparecchio incustodito durante l'essiccazione degli alimenti. Se l'apparecchio è predisposto per l'uso di una termosonda, usare solo i tipi di termosonda raccomandati per questo forno per evitare il rischio di incendi.

⚠ Non avvicinare all'apparecchio stoffe o altri materiali infiammabili fino a che tutti i componenti non si siano completamente raffreddati, per evitare il rischio di incendi. Sorvegliare continuamente la cottura degli alimenti ricchi di grasso o olio o le cotture con aggiunta di alcolici, perché queste preparazioni comportano un rischio di incendio. Usare guanti da forno per estrarre tegami e accessori. Alla fine della cottura, aprire lo sportello con cautela, lasciando defluire gradualmente l'aria o il vapore prima di accedere al vano del forno per evitare possibili rischi di ustioni. Non ostruire le aperture di sfogo dell'aria calda sul lato anteriore del forno, perché in tal caso potrebbe crearsi un rischio di incendio.

⚠ Fare attenzione quando la porta del forno è in posizione aperta o abbassata, per evitare di urtarla.

USO CONSENTITO

⚠ **ATTENZIONE:** l'apparecchio non è destinato ad essere messo in funzione mediante un dispositivo

IMPORTANTE: DA LEGGERE E OSSERVARE

di commutazione esterno, ad esempio un temporizzatore, o attraverso un sistema di comando a distanza separato.

⚠ L'apparecchio è destinato all'uso domestico e ad applicazioni analoghe, quali: aree di cucina per il personale di negozi, uffici e altri contesti lavorativi; agriturismi; camere di hotel, motel, bed & breakfast e altri ambienti residenziali.

⚠ Non sono consentiti altri usi (ad es., il riscaldamento di ambienti).

⚠ Questo apparecchio non è destinato ad applicazioni professionali. Non utilizzare l'apparecchio all'aperto.

⚠ Non conservare sostanze esplosive oppure infiammabili (ad es. taniche di benzina o bombolette spray) all'interno o in prossimità dell'apparecchio, per evitare il pericolo di incendi.

INSTALLAZIONE

⚠ Per evitare il rischio di lesioni personali, l'apparecchio deve essere movimentato e installato da due o più persone. Per le operazioni di disimballaggio e installazione utilizzare i guanti protettivi per non procurarsi tagli.

⚠ L'installazione, comprendente anche eventuali raccordi per l'alimentazione idrica e i collegamenti elettrici, e gli interventi di riparazione devono essere eseguiti da personale qualificato. Non riparare o sostituire qualsiasi parte dell'apparecchio se non specificatamente richiesto nel manuale d'uso. Tenere i bambini a distanza dal luogo dell'installazione. Dopo aver disimballato l'apparecchio, controllare che l'apparecchio non sia stato danneggiato durante il trasporto. In caso di problemi, contattare il rivenditore o il Servizio Assistenza di zona. A installazione completata, conservare il materiale di imballaggio (parti in plastica, polistirolo, ecc.) fuori della portata dei bambini per evitare il rischio di soffocamento. Per evitare rischi di scosse elettriche, prima di procedere all'installazione scollegare l'apparecchio dalla rete elettrica. Durante l'installazione, accertarsi che l'apparecchio non possa danneggiare il cavo di alimentazione e causare così rischi di scosse elettriche. Attivare l'apparecchio solo dopo avere completato la procedura di installazione.

⚠ Eseguire tutte le operazioni di taglio del mobile prima di inserire l'apparecchio, avendo cura di rimuovere trucioli o residui di segatura.

Non ostruire lo spazio minimo previsto tra il piano di lavoro e il bordo superiore del forno, perché in tal caso potrebbe crearsi un rischio di incendio.

Non rimuovere il forno dalla base di polistirolo fino al momento dell'installazione.

⚠ La parte inferiore dell'apparecchio non deve essere più accessibile dopo l'installazione, per evitare il rischio di ustioni.

⚠ Non installare l'apparecchio dietro un pannello decorativo, per evitare possibili rischi di incendio.

AVVERTENZE ELETTRICHE

⚠ La targhetta matricola si trova sul bordo frontale del forno (visibile a porta aperta).

⚠ Deve essere possibile scollegare l'apparecchio dalla rete elettrica disinserendo la spina, se questa è accessibile, o tramite un interruttore multipolare installato a monte della presa nel rispetto dei regolamenti elettrici vigenti; inoltre, la messa a terra dell'apparecchio deve essere conforme alle norme di sicurezza elettrica nazionali.

⚠ Non utilizzare cavi di prolunga, prese multiple o adattatori. Una volta terminata l'installazione, i componenti elettrici non dovranno più essere accessibili. Non utilizzare l'apparecchio quando si è bagnati oppure a piedi nudi. Non accendere l'apparecchio se il cavo di alimentazione o la spina sono danneggiati, se si osservano anomalie di funzionamento o se l'apparecchio è caduto o è stato danneggiato.

⚠ Se il cavo di alimentazione è danneggiato, deve essere sostituito con uno dello stesso tipo dal produttore, da un centro di assistenza autorizzato o da un tecnico qualificato per evitare situazioni di pericolo o rischi di scosse elettriche.

⚠ Per la sostituzione del cavo di alimentazione, contattare un centro di assistenza autorizzato.

PULIZIA E MANUTENZIONE

⚠ **AVVERTENZA:** Per evitare rischi di folgorazione, prima di qualsiasi intervento di manutenzione accertarsi che l'apparecchio sia spento e scollegato dall'alimentazione elettrica; inoltre, non usare in nessun caso pulitrici a getto di vapore.

⚠ Non utilizzare detergenti abrasivi o raschietti metallici per pulire la porta del forno in vetro, in quanto potrebbero graffiarne la superficie e causarne la frantumazione.

⚠ Attendere che l'apparecchio si sia raffreddato prima di eseguire qualsiasi operazione di pulizia o manutenzione, per evitare possibili rischi di ustione.

⚠ **AVVERTENZA:** Spegnerne l'apparecchio prima di sostituire la lampadina, per evitare il rischio di scosse elettriche.

SMALTIMENTO DEL MATERIALE DI IMBALLAGGIO

Il materiale di imballaggio è riciclabile al 100% ed è contrassegnato dal simbolo del riciclaggio .

Le varie parti dell'imballaggio devono pertanto essere smaltite responsabilmente e in stretta osservanza delle norme stabilite dalle autorità locali.

SMALTIMENTO DEGLI ELETTRODOMESTICI

Questo prodotto è stato fabbricato con materiale riciclabile o riutilizzabile. Smaltire il prodotto rispettando le normative locali in materia. Per ulteriori informazioni sul trattamento, il recupero e il riciclaggio degli elettrodomestici, contattare l'ufficio locale competente, il servizio di raccolta dei rifiuti domestici o il negozio presso il quale il prodotto è stato acquistato. Questo apparecchio è contrassegnato in conformità alla direttiva europea 2012/19/UE, Rifiuti di apparecchiature elettriche ed elettroniche (RAEE) e alle norme sui rifiuti di apparecchiature elettriche ed elettroniche 2013 (e successive modifiche).

Assicurandosi che questo prodotto sia smaltito in modo corretto, l'utente contribuisce a prevenire le conseguenze negative per l'ambiente e la salute.

- Il simbolo  sul prodotto o sulla documentazione di accompagnamento indica che questo apparecchio non deve essere smaltito come rifiuto domestico, bensì conferito presso un centro di raccolta preposto al ritiro delle apparecchiature elettriche ed elettroniche.

CONSIGLI PER IL RISPARMIO ENERGETICO

Preriscaldare il forno solo se specificato nella tabella di cottura o nella ricetta. Usare teglie laccate o smaltate in colori scuri, in quanto assorbono il calore in modo più efficiente. Gli alimenti che richiedono tempi di cottura lunghi continueranno comunque a cuocere anche a forno spento.

DICHIARAZIONE DI PROGETTAZIONE ECOCOMPATIBILE

Questo apparecchio soddisfa quanto segue: Requisiti di Ecodesign del regolamento europeo 66/2014; Regolamento 65/2014 sull'etichettatura energetica; Ecodesign per i prodotti connessi all'energia e informazioni sull'energia (emendamento) (Uscita UE) Regolamenti 2019, in conformità con la norma europea EN 60350-1.

GUIDA RAPIDA



GRAZIE PER AVERE ACQUISTATO UN PRODOTTO WHIRLPOOL

Per ricevere un'assistenza più completa, registrare il prodotto su www.whirlpool.eu/register



Scaricare le istruzioni per la sicurezza e le istruzioni per l'uso collegandosi al sito docs.whirlpool.eu e seguire la procedura indicata sul retro.

! Leggere attentamente le istruzioni per la sicurezza prima di utilizzare il prodotto.

DESCRIZIONE PRODOTTO

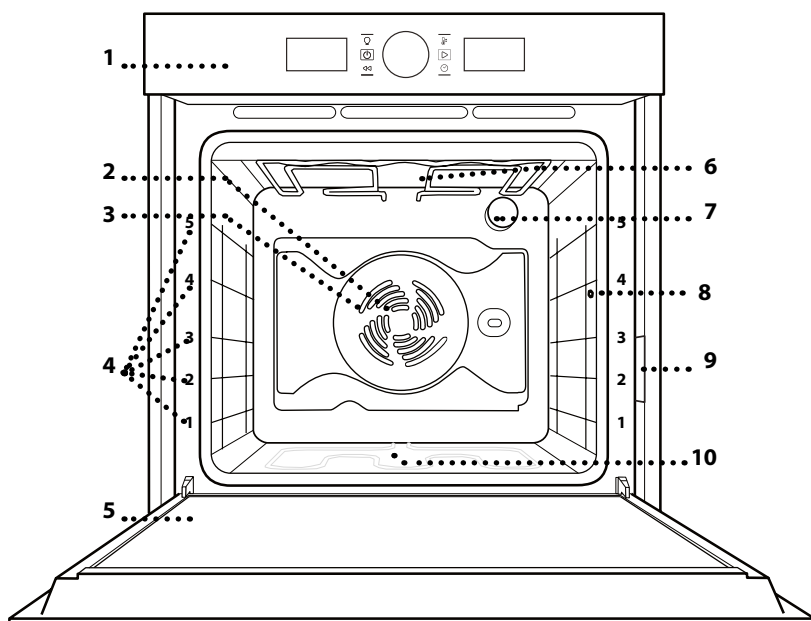

1. Pannello comandi
2. Ventola
3. Resistenza circolare (non visibile)
4. Griglie laterali (il livello è indicato sulla parte frontale del forno)
5. Porta
6. Resistenza superiore / grill
7. Lampada
8. Punto di inserimento della sonda carne (se in dotazione)
9. Targhetta matricola (da non rimuovere)
10. Resistenza inferiore (non visibile)

PANNELLO COMANDI

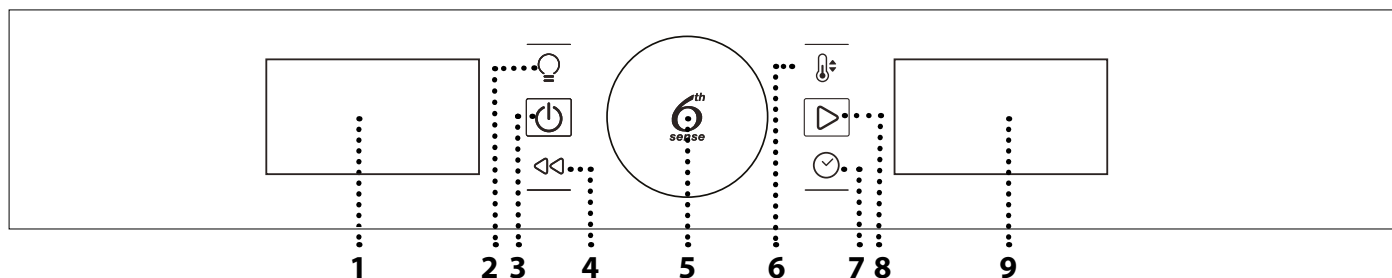

1. PARTE SINISTRA DEL DISPLAY

2. LUCE

Per accendere/spegnere la lampadina.

3. ON/OFF

Per accendere e spegnere il forno o terminare in qualunque momento una funzione attiva.

4. INDIETRO

Per tornare alla schermata precedente durante le impostazioni.

5. MANOPOLA GIREVOLE / TASTO 6TH SENSE

Ruotando la manopola è possibile spostarsi tra le funzioni e regolare i parametri di cottura. Premere  per selezionare, impostare, visualizzare e confermare le funzioni o i parametri e per avviare i programmi di cottura.

6. TEMPERATURA

Per impostare la temperatura.

7. TEMPO

Per impostare o modificare l'orologio e regolare il tempo di cottura.

8. AVVIO

Per avviare le funzioni, confermando i valori impostati.

9. PARTE DESTRA DEL DISPLAY

ACCESSORI

GRIGLIA

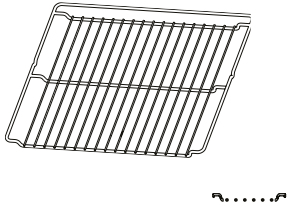

LECCARDA

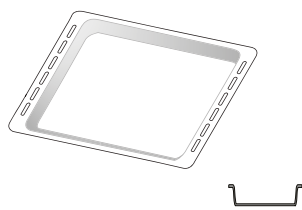

TEGLIA

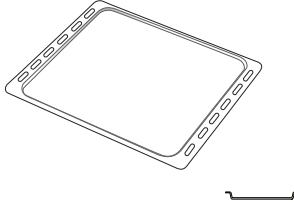

GUIDE SCORREVOLI (SOLO IN ALCUNI MODELLI)

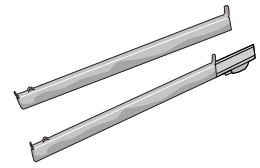

TERMOSONDA (SOLO IN ALCUNI MODELLI)

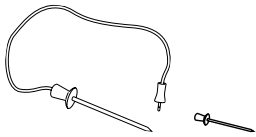

Il numero di accessori può variare a seconda del modello acquistato.

È possibile acquistare separatamente altri accessori presso il Servizio Assistenza Clienti.

INSERIRE LA GRIGLIA E ALTRI ACCESSORI

Inserire la griglia orizzontalmente facendola scivolare sulle griglie laterali inserendo dapprima il lato rialzato orientato verso l'alto.

Gli altri accessori, come la leccarda o la piastra dolci, si inseriscono orizzontalmente come la griglia.

MONTARE LE GUIDE SCORREVOLI (SE PRESENTI)

Togliere dal forno le griglie laterali e rimuovere la protezione in plastica dalle guide scorrevoli.

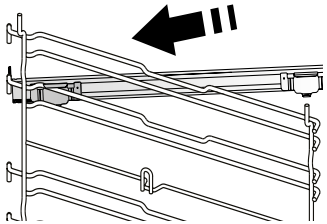

Ancorare alla griglia laterale la clip superiore della guida e farla scivolare fino a fine corsa; abbassare in posizione l'altra clip.

Per fissare la guida, premere la parte inferiore della clip contro la griglia laterale. Assicurarsi che le guide possano scorrere liberamente. Ripetere questa operazione sull'altra griglia laterale, allo stesso livello.

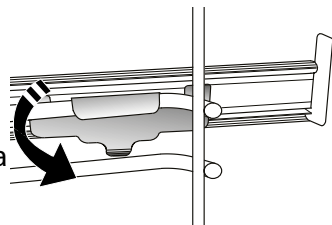

Note: le guide scorrevoli possono essere montate su qualsiasi livello.

TOGLIERE E RIMONTARE LE GRIGLIE LATERALI

Per togliere le griglie, togliere la vite di fissaggio (se presente) e quindi sollevare le griglie prima di scostare la parte inferiore dalle proprie sedi: a questo punto è possibile rimuovere le griglie.

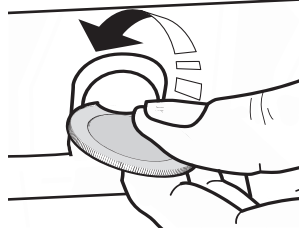
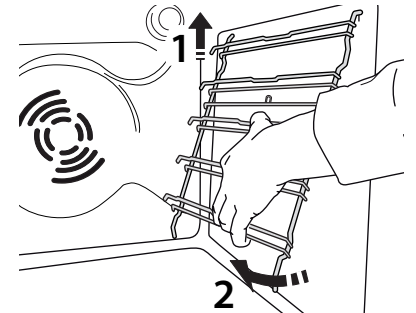
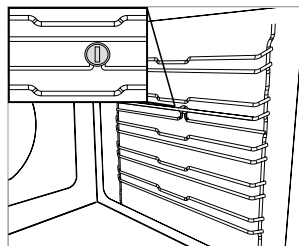

Per rimontare le griglie, inserirle dapprima nelle sedi superiori. Avvicinarle alla cavità tenendo sollevato, quindi abbassarle in posizione nelle sedi inferiori.

FUNZIONI



STATICO

Per cuocere qualsiasi tipo di pietanza su un solo ripiano.



GRILL

Per grigliare costate, spiedini e salsicce, gratinare verdure o dorare il pane. Per la grigliatura delle carni, si consiglia di utilizzare una leccarda per raccogliere il liquido di cottura: posizionarla a un livello sotto la griglia e aggiungere 500 ml di acqua potabile.



TERMOVENTILATO

Per cuocere contemporaneamente su più ripiani (massimo tre) alimenti, anche diversi, che richiedono medesima temperatura di cottura. La funzione permette di cuocere senza trasmissione di odori da un alimento all'altro.



VENTILATO

Per cuocere carni, torte ripiene o verdure ripiene su un solo ripiano. Questa funzione utilizza una ventilazione discontinua e delicata, che previene l'eccessiva disidratazione delle pietanze.



FUNZIONI 6TH SENSE



PRIMI PIATTI

Questa funzione seleziona automaticamente la migliore temperatura e modalità di cottura per le pietanze a base di pasta.



CARNE

Questa funzione seleziona automaticamente la migliore temperatura e modalità di cottura per le carni. Questa funzione attiva a intermittenza la ventola a bassa velocità per evitare che i cibi si seccino eccessivamente.



MAXI COOKING

Questa funzione seleziona automaticamente la migliore temperatura e modalità di cottura per tagli di carne di grandi dimensioni (oltre 2,5 kg). Si suggerisce di girare la carne durante la cottura per ottenere una doratura omogenea su entrambi i lati. È preferibile irrorarla di tanto in tanto con il fondo di cottura per evitare che si asciughi eccessivamente.



PANE

Questa funzione seleziona automaticamente la migliore temperatura e modalità di cottura per qualsiasi tipo di pane.



MULTICRISP

Questa funzione seleziona automaticamente la migliore temperatura e modalità di cottura per qualsiasi tipo di pizza.



TORTE DOLCI

Questa funzione seleziona automaticamente la migliore temperatura e modalità di cottura per torte di qualsiasi tipo.



FUNZIONI SPECIALI



PRERISCALDAMENTO RAPIDO

Per riscaldare rapidamente il forno. Alla fine del preriscaldamento il forno selezionerà automaticamente la funzione "Statico". Attendere il termine del preriscaldamento prima di inserire il cibo nel forno.



TURBO GRILL

Per arrostiti grossi pezzi di carne (cosciotti, roast beef, polli). si consiglia di utilizzare una leccarda per raccogliere il liquido di cottura: posizionarla a un livello sotto la griglia e aggiungere 500 ml di acqua potabile. Con questa funzione è possibile utilizzare il girarrosto, se presente.



ECO TERMOVENTILATO*

Per cuocere arrostiti ripieni e filetti di carne su uno stesso ripiano. La circolazione intermittente dell'aria impedisce un'eccessiva asciugatura degli alimenti. In questa funzione ECO la luce rimane spenta durante la cottura. Per utilizzare il ciclo ECO e ottimizzare quindi i consumi energetici, la porta forno non deve essere aperta fino a completamento della cottura del cibo.



MANTENERE IN CALDO

Per mantenere caldi e croccanti cibi appena cotti.



LIEVITAZIONE

Per ottenere una lievitazione ottimale di impasti dolci o salati. Per preservare la qualità della lievitazione, non attivare la funzione se il forno è ancora caldo dopo un ciclo di cottura.



SMART CLEAN

(SOLO IN ALCUNI MODELLI)

L'azione del vapore rilasciato durante questo speciale ciclo di pulizia a bassa temperatura permette di rimuovere facilmente sporco e residui di cibo. Versare 200 ml di acqua potabile sul fondo del forno, attivando la funzione a forno freddo.

* Funzione di riferimento per la dichiarazione di efficienza energetica in accordo con il Regolamento europeo 65/2014

PRIMO UTILIZZO

1. IMPOSTARE L'ORA

Alla prima accensione, è necessario impostare l'ora.



Sul display lampeggiano le due cifre relative alle ore: ruotare la manopola per impostare l'ora, e premere  per confermare.



Sul display lampeggiano le due cifre relative ai minuti: ruotare la manopola per impostare i minuti e premere  per confermare.

Note: per modificare successivamente l'ora, a forno spento tenere premuto  per almeno 1 secondo e ripetere le operazioni sopra descritte.

Dopo una prolungata interruzione di corrente potrebbe essere necessario impostare nuovamente l'ora.

2. IMPOSTAZIONI

Se necessario, è possibile modificare le impostazioni predefinite per l'unità di misura della temperatura e l'intensità della corrente elettrica (°C e 16 A).

A forno spento, tenere premuto  per almeno 5 secondi.



Ruotare la manopola per selezionare l'unità di misura, quindi premere  per confermare.



Ruotare la manopola per indicare l'assorbimento di potenza, quindi premere  per confermare.

Note: il forno è programmato per assorbire una potenza elettrica compatibile con una rete domestica di capacità superiore a 3 kW (16 A): nel caso si disponga di una potenza inferiore, è necessario diminuire il valore (13 A).

3. RISCALDARE IL FORNO

Un nuovo forno può rilasciare degli odori dovuti alla lavorazione di fabbrica: questo è normale. Prima di cucinare gli alimenti è dunque raccomandato di riscaldare a vuoto il forno per rimuovere ogni odore.

Rimuovere protezioni di cartone o pellicole trasparenti e togliere gli accessori dal forno. Riscaldare il forno a 200 °C per circa 1 ora utilizzando preferibilmente una funzione ventilata ("Termoventilato" o "Ventilato"). Seguire le istruzioni a seguire per impostare correttamente la funzione.

Note: è opportuno ventilare la stanza durante e dopo il primo utilizzo.

USO QUOTIDIANO

1. SELEZIONARE UNA FUNZIONE

Quando il forno è spento, è visualizzato solo l'orologio: tenere premuto  per accendere il forno.

Ruotare la manopola per visualizzare sul display sinistro le funzioni principali disponibili e premere  per confermare.

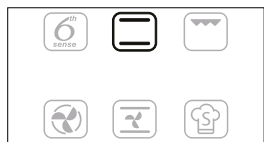

Dove presente, per selezionare una sottofunzione, dopo aver selezionato la funzione principale, premere  per confermare e accedere al menu delle funzioni.

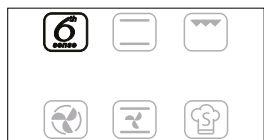

Ruotare la manopola per visualizzare sul display destro una tra le sottofunzioni disponibili e premere  per confermare.

2. IMPOSTARE LA FUNZIONE

Dopo aver selezionato la funzione desiderata, è possibile modificare i valori. Il display mostra in sequenza i valori che è possibile modificare.

TEMPERATURA / LIVELLO GRILL



Quando l'icona °C/°F lampeggia sul display, ruotare la manopola per modificare il valore, quindi premere  per confermare e procedere con le impostazioni seguenti, per tutti i valori che è possibile regolare.

Allo stesso modo, è possibile impostare il livello del grill (3 alto, 2 medio, 1 basso).



Note: una volta attivata la funzione, sarà possibile modificare la temperatura o il livello del grill premendo o ruotando direttamente la manopola.

DURATA



Quando l'icona lampeggia sul display, utilizzare la manopola per impostare il tempo di cottura desiderato, quindi premere per confermare.

È possibile non impostare il tempo di cottura per gestire la cottura manualmente: Premere per confermare e avviare la funzione.

In questo caso, non sarà possibile impostare l'ora di fine cottura, programmando l'avvio ritardato.

Note: durante la cottura, premendo è possibile regolare il tempo impostato: ruotare la manopola per impostare l'ora, e premere per confermare.

IMPOSTARE L'ORA DI FINE COTTURA/ (AVVIO RITARDATO)

In molte funzioni, una volta impostato un tempo di cottura, è possibile posticipare l'avvio, programmando l'ora di fine.

Dove possibile modificare l'ora di fine, il display mostra l'ora di fine della funzione prevista mentre l'icona lampeggia.



Se necessario, ruotare la manopola per impostare l'ora di fine cottura desiderata, quindi premere per confermare, attivando la funzione.

Inserire il cibo nel forno e chiudere la porta: la funzione si avvierà automaticamente dopo un periodo di tempo calcolato per terminare la cottura all'orario impostato.



Note: programmare l'avvio ritardato di una cottura, disattiva in ogni caso la fase di preriscaldamento del forno: la temperatura desiderata viene raggiunta gradualmente, quindi i tempi di cottura si allungheranno leggermente rispetto a quanto indicato nella tabella di cottura.

Durante il tempo di attesa, è possibile utilizzare la manopola per regolare l'ora di fine programmata.

Premere o per modificare i valori impostati rispettivamente di temperatura e tempo di cottura: una volta modificati, premere per confermare.

Note: Il ritardo di avvio della funzionalità non è disponibile per le funzioni Grill e Turbo Grill.

3. AVVIARE LA FUNZIONE

Una volta che i valori corrispondono a quelli desiderati, premere per avviare la funzione.

Tenere premuto per interrompere in ogni momento la funzione attivata.

4. PRERISCALDAMENTO

In alcune funzioni, è prevista una fase di preriscaldamento del forno: una volta avviata la funzione, il display segnala che si è attivata la fase di preriscaldamento.



Al termine di questa fase, un segnale acustico e il display indicheranno che il forno ha raggiunto la temperatura impostata.



A questo punto, aprire la porta, inserire gli alimenti nel forno, chiudere la porta e procedere alla cottura premendo .

Note: introdurre gli alimenti nel forno prima della fine del preriscaldamento può avere effetti negativi sui risultati della cottura.

Aperto la porta durante la fase di preriscaldamento, questa si interrompe temporaneamente.

Il tempo di cottura impostato non prevede la fase di preriscaldamento.

È sempre possibile modificare la temperatura che si desidera raggiungere utilizzando la manopola.

5. FINE COTTURA

Un segnale acustico e il display avviseranno del termine di una cottura.



Per prolungare la cottura mantenendo i valori impostati, ruotare la manopola per impostare un nuovo tempo di cottura e premere .

. FUNZIONI 6th SENSE

RECUPERO TEMPERATURA

Se, durante un ciclo di cottura automatico, la temperatura all'interno del forno si abbassa a causa dell'apertura della porta, una speciale funzione ripristina automaticamente la temperatura originale. Durante il ripristino della temperatura, il display mostra un'animazione a "serpente" fino al ripristino della temperatura impostata.

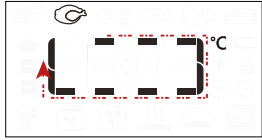



Durante un ciclo di cottura programmato, per garantire un risultato ottimale il tempo di cottura viene aumentata in misura del tempo di apertura della porta.

. FUNZIONI SPECIALI

SMART CLEAN

Per attivare la funzione "Smart Clean", a forno freddo versare 200 ml d'acqua sul fondo della cavità e quindi chiudere la porta.

Accedere alle funzioni speciali  e ruotare la manopola per selezionare  dal menu. Quindi premere  per confermare.

Premere  per avviare subito il ciclo di pulizia, oppure premere  per impostare l'ora di fine o l'avvio ritardato.

Alla fine del ciclo, lasciare raffreddare il forno, rimuovere l'acqua residua e pulire con una spugna inumidita con acqua calda (la pulizia può risultare meno efficace se si aspetta per più di 15 minuti).

Note: La durata e la temperatura del ciclo di pulizia non possono essere impostate.

. USO DELLA SONDA CARNE (SE PRESENTE)

La sonda carne in dotazione permette di misurare l'esatta temperatura interna degli alimenti durante la cottura.

La sonda carne può essere utilizzata solo con alcune funzioni di cottura (Statico, Termoventilato, Ventilato, TurboGrill, 6th Sense Carne e 6th Sense Maxicooking).

È molto importante posizionare accuratamente la sonda per ottenere risultati di cottura perfetti. Inserire la sonda a fondo nella parte più carnosa, evitando ossa e parti grasse.

Per il pollame, la sonda va inserita trasversalmente, al centro del petto, evitando che la punta finisca in una parte cava. Se la carne ha uno spessore molto irregolare, controllare che sia cotta

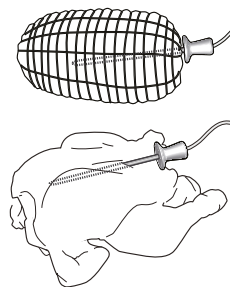

al punto desiderato prima di estrarla dal forno. Inserire l'estremità della sonda nel foro situato sulla parete interna destra del forno.





Quando la sonda carne viene inserita nel forno, viene emesso un segnale acustico e il display mostra l'icona e la temperatura desiderata.

Se la sonda carne viene inserita durante la selezione di una funzione, l'indicazione del display cambia per mostrare la temperatura impostata per la sonda.





Premere  per iniziare l'impostazione dei valori. Ruotare la manopola per impostare la temperatura desiderata per la sonda. Premere  per confermare. Ruotare la manopola per impostare la temperatura interna del forno.



Premere  o  per confermare e avviare il ciclo di cottura.

Durante il ciclo di cottura, il display mostra la temperatura impostata per la sonda. Quando la carne raggiunge la temperatura impostata, il ciclo di cottura si interrompe e sul display compare l'indicazione "End" (Fine).

Per riavviare il ciclo di cottura dopo la comparsa dell'indicazione "End", ruotare la manopola per regolare la temperatura della sonda come descritto in precedenza. Premere  o  per confermare e riavviare il ciclo di cottura.

Note: durante un ciclo di cottura con la sonda carne, è possibile ruotare la manopola per cambiare la temperatura della sonda. Premere  per regolare la temperatura interna del forno.

La sonda carne può essere inserita in qualunque momento, anche durante un ciclo di cottura. In questo caso, sarà necessario reimpostare i parametri della funzione di cottura. Se la sonda carne non è compatibile con la funzione prescelta, il forno interromperà il ciclo di cottura e sarà emesso un segnale acustico. In questo caso, scollegare la sonda carne o premere  per impostare un'altra funzione. L'avvio ritardato e la fase di preriscaldamento non sono compatibili con l'uso della sonda.

. BLOCCO A CHIAVE

Per bloccare i tasti, tenere premuto  per almeno 5 secondi.



Per disattivare, ripetere la stessa procedura.

Note: il blocco a chiave può essere attivato anche durante la cottura.

Per ragioni di sicurezza, è possibile spegnere il forno in ogni momento premendo .

CONSIGLI UTILI

COME LEGGERE LA TABELLA DI COTTURA

La tabella indica la funzione, gli accessori e il livello migliore da utilizzare per cuocere svariati tipi di cibo. I tempi di cottura iniziano dall'introduzione degli alimenti nel forno, escluso il preriscaldamento (dove richiesto). Le temperature e i tempi di cottura sono indicativi e dipendono dalla quantità di cibo e dal tipo di accessori. Utilizzare inizialmente i valori più bassi consigliati e, se il risultato della cottura non è quello desiderato, passare a quelli più alti. Si consiglia di utilizzare gli accessori in dotazione e tortiere o teglie possibilmente in metallo scuro. È possibile utilizzare anche tegami e accessori in pyrex o in ceramica, ma occorre considerare che i tempi di cottura si allungheranno leggermente.

COTTURA DI CIBI DIVERSI CONTEMPORANEAMENTE

Utilizzando la funzione "Termoventilato", è possibile cuocere contemporaneamente cibi diversi (ad esempio: pesce e verdure), su ripiani diversi. Estrarre i cibi che richiedono tempi di cottura inferiori e lasciare continuare la cottura per quelli con tempi più lunghi.

CARNE

Utilizzare qualunque tipo di teglia o pirofila adatta alle dimensioni della carne da cuocere. Per gli arrostiti, aggiungere preferibilmente del brodo sul fondo della pirofila inumidendo la carne durante la cottura per insaporirla. Fare attenzione al vapore che si sviluppa durante tale operazione. Quando l'arrostito è pronto, lasciarlo riposare in forno per altri 10-15 minuti oppure avvolgerlo in un foglio di alluminio.

Per la cottura uniforme della carne alla griglia, scegliere tagli dello stesso spessore. I pezzi di carne molto spessi richiedono tempi di cottura più lunghi. Per evitare che si brucino in superficie, allontanarli dal grill disponendoli su ripiani più bassi. Girare la carne a due terzi della cottura. Aprire con cautela la porta in quanto può fuoriuscire vapore caldo.

Si consiglia di posizionare una leccarda con mezzo litro d'acqua potabile direttamente sotto la griglia sulla quale avete posizionato il cibo da grigliare, per raccogliere il liquido di cottura. Rabboccare quando necessario.

DESSERT

Cuocere i dolci delicati con la funzione "Statico" su un solo livello.

Utilizzare tortiere in metallo scuro e posizionarle sempre sulla griglia in dotazione. Per la cottura su più livelli, selezionare la funzione "Termoventilato" e disporre le tortiere sulle griglie in modo disallineato, al fine di favorire la circolazione dell'aria.

Per capire se la torta lievitata è cotta, inserire uno stuzzicadenti nella parte centrale del dolce. Se lo stuzzicadenti rimane asciutto, il dolce è pronto.

Se si utilizzano tortiere antiaderenti, non imbrattare i bordi; il dolce potrebbe non crescere uniformemente su tutti i lati.

Se il dolce si "sgonfia" durante la cottura, la volta successiva utilizzare una temperatura inferiore, magari riducendo la quantità di liquido e mescolando più delicatamente l'impasto.

I dolci con guarnitura succosa (torte al formaggio o con frutta) richiedono la funzione "Ventilato". Se il fondo della torta risulta troppo umido, usare un ripiano più basso e cospargere la base del dolce di pan grattato o biscotti sbriciolati prima di aggiungere il ripieno.

















































































PIZZA

Ungere leggermente le teglie per ottenere una pizza croccante anche sul fondo. Distribuire la mozzarella sulla pizza a due terzi della cottura.

LIEVITAZIONE

Si consiglia di coprire l'impasto con un panno umido prima di introdurlo nel forno. Con questa funzione, i tempi di lievitazione si riducono di circa un terzo rispetto ai tempi di lievitazione a temperatura ambiente (20-25 °C). Il tempo di lievitazione di 1 kg di impasto per pizza è di circa un'ora.

TABELLA DI COTTURA

RICETTA	FUNZIONE	PRERISC.	TEMPERATURA (°C)	TEMPO COTTURA (Min.)	LIVELLO E ACCESSORI
Torte lievitate / Pan di Spagna		-	170	30 - 50	2 
		Sì	160	30 - 50	2 
		Sì	160	30 - 50	4 1  
Torte ripiene (torta di ricotta, strudel, torta di mele)		-	160 - 200	30 - 85	3 
		Sì	160 - 200	35 - 90	4 1  
Biscotti / Crostatine		-	160 - 170	20 - 40	3 
		Sì	150 - 160	20 - 40	3 
		Sì	150 - 160	20 - 40	4 1  
Bignè		-	180 - 200	30 - 40	3 
		Sì	180 - 190	35 - 45	4 1  
		Sì	180 - 190	35 - 45*	5 3 1   
Meringhe		Sì	90	110 - 150	3 
		Sì	90	130 - 150	4 1  
		Sì	90	140 - 160*	5 3 1   
Pizza (sottile, alta, focaccia)		-	220 - 250	20 - 40	2 
		Sì	220 - 240	20 - 40	4 1  
		Sì	220 - 240	25 - 50*	5 3 1   
Pagnotta 0,5 kg		-	180 - 220	50 - 70	2 
Panini		-	180 - 220	30 - 50	3 
Pane		Sì	180 - 220	30 - 60	4 1  
Pizza surgelata		-	250	10 - 20	2 
		Sì	250	10 - 20	4 1  
Torte salate (torta di verdura, quiche)		Sì	180 - 190	45 - 60	2 
		Sì	180 - 190	45 - 60	4 1  
		Sì	180 - 190	45 - 70*	5 3 1   
Vols-au-vent / Salatini di pasta sfoglia		Sì	190 - 200	20 - 30	3 
		Sì	180 - 190	20 - 40	4 1  
		Sì	180 - 190	20 - 40*	5 3 1   
Lasagne/Timballi		-	190 - 200	40 - 65	3 
Pasta al forno/Cannelloni		-	190 - 200	25 - 45	3 

RICETTA	FUNZIONE	PRERISC.	TEMPERATURA (°C)	TEMPO COTTURA (Min.)	LIVELLO E ACCESSORI
Agnello / Vitello / Manzo / Maiale 1 Kg		-	190 - 200	60 - 90	3
Arrosto di maiale con cotenna 2 kg		-	170	110 - 150	2
Pollo / Coniglio / Anatra 1 kg		-	200 - 230	50 - 80 **	3
Tacchino / Oca 3 kg		-	190 - 200	90 - 150	2
Pesce al forno / al cartoccio (filetti, intero)		Sì	180 - 200	40 - 60	3
Verdure ripiene (pomodori, zucchine, melanzane)		Sì	180 - 200	50 - 60	2
Toast		-	3 (Alta)	3 - 6	5
Filetti/Tranci di pesce		-	2 (media)	20 - 30***	4 3
Salsicce / Spiedini / Costine / Hamburger		-	2 - 3 (media - alta)	15 - 30***	5 4
Pollo arrosto 1-1,3 kg		-	2 (media)	55 - 70**	2 1
Roast beef al sangue (1 kg)		-	2 (media)	35 - 50**	3
Cosciotto d'agnello/Stinco		-	2 (media)	60 - 90**	3
Patate arrosto		-	2 (media)	35 - 55**	3
Verdure gratinate		-	3 (Alta)	10 - 25	3
Pasto completo: Crostata di frutta (Liv. 5) / Lasagna (Liv. 3) / Carne (Liv. 1)		Sì	190	40 - 120*	5 3 1
Lasagne e carne		Sì	200	50 - 120*	4 1
Carne e patate		Sì	200	45 - 120*	4 1
Pesce e verdure		Sì	180	30 - 50	4 1
Arrosti ripieni		-	200	80 - 120*	3
Tagli di carne (coniglio, pollo, agnello)		-	200	50 - 120*	3

* Il tempo di cottura è indicativo: le pietanze possono essere tolte dal forno in tempi differenti secondo preferenza.

** Ruotare il cibo a due terzi di cottura se necessario.

*** Girare gli alimenti a metà cottura.

Note: la funzione 6th Sense "Torte dolci" utilizza solo le resistenze superiore e inferiore, senza ventilazione. Non è richiesto il preriscaldamento del forno.

FUNZIONI	Statico	Grill	Turbo Grill	Termoventilato	Ventilato	Eco termoventilato
FUNZIONI AUTOMATICHE	Primi piatti	Carne	Maxi Cooking	Pane	Pizza	Torte dolci
ACCESSORI	Griglia	Pirofila o tortiera su griglia	Leccarda / piastra dolci o teglia su griglia	Leccarda / Piastra dolci	Leccarda con 500 ml di acqua	

PULIZIA E MANUTENZIONE

Assicurarsi che il forno si sia raffreddato prima di eseguire ogni operazione.

Non utilizzare pulitrici a getto di vapore.

Non usare pagliette metalliche, panni abrasivi e detersivi abrasivi o corrosivi che possano danneggiare le superfici.

Utilizzare guanti protettivi.

Il forno deve essere disconnesso dalla rete elettrica prima di effettuare operazioni di manutenzione.

SUPERFICI ESTERNE

- Pulire le superfici con un panno in microfibra umido. Se molto sporche, aggiungere qualche goccia di detersivo neutro. Asciugare con un panno asciutto.
- Non usare detersivi corrosivi o abrasivi. Se inavvertitamente uno di questi prodotti dovesse venire a contatto con le superfici, pulire subito con un panno in microfibra umido.

SUPERFICI INTERNE

- Dopo ogni uso, lasciare raffreddare il forno e pulirlo preferibilmente quando è ancora tiepido per rimuovere incrostazioni e macchie dovute a residui di cibo; per asciugare la condensa dovuta alla cottura di alimenti con un elevato contenuto di acqua, usare a forno freddo un panno o una spugna.

- Pulire i vetri della porta con detersivi liquidi specifici.
- Attivare la funzione "Smart Clean" (se presente) per una pulizia ottimale delle superfici interne.
- Per facilitare la pulizia della porta è possibile rimuoverla.
- La resistenza superiore del grill può essere abbassata per pulire la parete superiore del forno.

ACCESSORI

Mettere a bagno gli accessori con detersivo per piatti dopo l'uso, maneggiandoli con guanti da forno, se ancora caldi. I residui di cibo possono essere rimossi con una spazzola per piatti o con una spugna.

PULIZIA DEI PANNELLI CATALITICI

(SOLO IN ALCUNI MODELLI)

Questo forno è equipaggiato con degli speciali pannelli catalitici che facilitano la pulizia della cavità grazie a un particolare rivestimento autopulente ad alta porosità, in grado di catturare lo sporco. Questi pannelli sono montati sulle griglie laterali: quando queste vengono rimontate, per un corretto posizionamento, assicurarsi che l'aggancio superiore delle griglie sia infilato negli appositi fori dei pannelli.

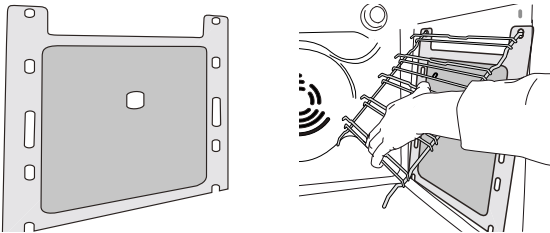

Per utilizzare al meglio le proprietà autopulenti, si consiglia di riscaldare il forno a 200 °C per circa 1 ora utilizzando la funzione "Ventilato". Durante questa procedura il forno deve essere vuoto. Lasciare quindi raffreddare l'apparecchio e infine rimuovere eventuali residui di alimenti con una spugna non abrasiva.

Note: l'uso di detersivi corrosivi o abrasivi, spazzole ruvide, spugne abrasive per pentole o spray per forno possono danneggiare la superficie catalitica, facendole perdere le sue particolari proprietà.

Nel caso fosse necessaria la sostituzione dei pannelli, rivolgersi al Servizio Assistenza.

SOSTITUIRE LA LAMPADA

1. Scollegare il forno dalla rete elettrica.
2. Svitare la copertura della lampada, sostituire la lampada e avvitarla di nuovo il coperchio della lampada.
3. Ricollegare il forno alla rete elettrica.

Nota: usare solo lampade alogene da 20-40 W/230 ~ V tipo G9, T300 °C. La lampada utilizzata nel prodotto è specifica per elettrodomestici e non è adatta per l'illuminazione di ambienti domestici (Regolamento (CE) 244/2009). Le lampade sono disponibili presso il Servizio Assistenza.

- In caso di impiego di lampade alogene, non maneggiarle a mani nude, per evitare che vengano danneggiate dalle impronte digitali. Non far funzionare il forno senza prima aver riposizionato il coperchio. Questo prodotto contiene una sorgente luminosa con classe di efficienza energetica G.

ABBASSARE LA RESISTENZA SUPERIORE

(SOLO IN ALCUNI MODELLI)

1. Rimuovere le griglie laterali.

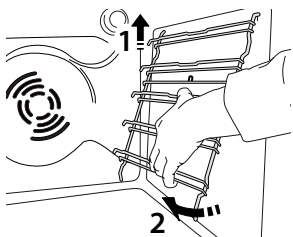

2. Estrarre leggermente la resistenza e abbassarla.

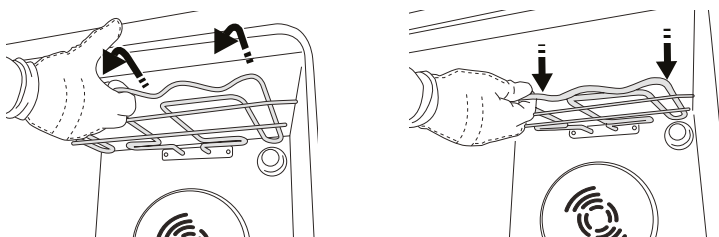

3. Per riposizionare la resistenza, sollevarla, tirandola leggermente verso di sé, assicurandosi che poggi sulle apposite sedi laterali.

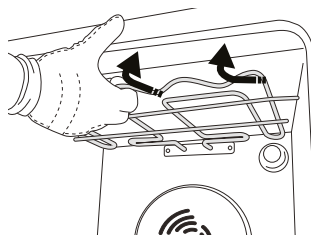

TOGLIERE E RIMONTARE LA PORTA

1. Per rimuovere la porta, aprirla completamente e abbassare i fermi fino alla posizione di sblocco.

2. Chiudere la porta fino a quando è possibile. Prendere saldamente la porta con entrambe le mani, evitando di tenerla per la maniglia.

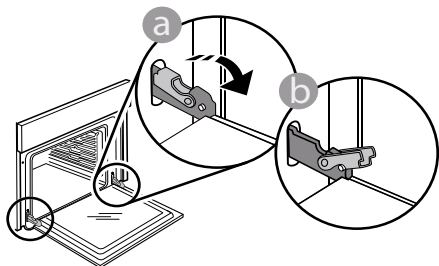

Per estrarla facilmente, continuare a chiuderla e contemporaneamente tirarla verso l'alto finché non esce dalle sedi. Togliere la porta e appoggiarla su un piano morbido.

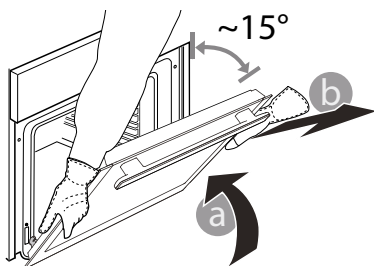

3. Per rimontare la porta, avvicinarla al forno allineando i ganci delle cerniere alle proprie sedi e ancorare la parte superiore agli alloggiamenti.

4. Abbassare la porta e poi aprirla completamente. Abbassare i fermi nella posizione originale: fare attenzione che siano completamente abbassati.

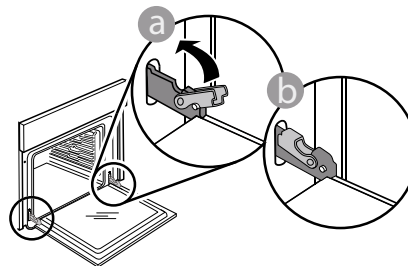

Sarà necessario applicare una leggera pressione per assicurare il corretto posizionamento dei fermi.

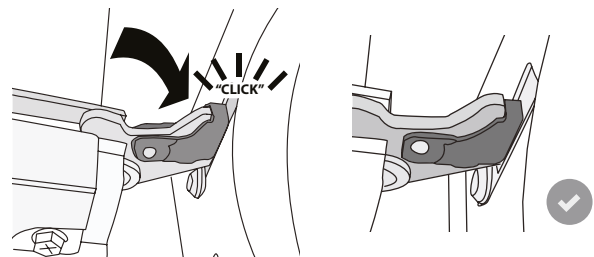

5. Provare a chiudere la porta, verificando che sia allineata al pannello di controllo. Se non lo fosse, ripetere tutte le operazioni: funzionando male, la porta potrebbe danneggiarsi.

RISOLUZIONE DEI PROBLEMI

Problema	Possibile causa	Soluzione
Il forno non funziona.	Interruzione di corrente elettrica. Disconnessione dalla rete principale.	Verificare che ci sia tensione in rete e che il forno sia collegato all'alimentazione elettrica. Spegnere e riaccendere il forno e verificare se l'inconveniente persiste.
Il display mostra la lettera "F" seguita da un numero o una lettera.	Problema software.	Contattare il più vicino Servizio Assistenza Clienti e specificare il numero che segue la lettera "F".
Il display visualizza un testo poco chiaro e sembra essere guasto.difficile à lire et semble cassé.	Un'altra lingua impostata.	Contatta il Servizio Assistenza Tecnica più vicino.

SCHEDA TECNICA

 [www](http://www.docs.whirlpool.eu) La scheda tecnica del prodotto con i dati del consumo energetico è scaricabile dal sito web **docs.whirlpool.eu**

COME OTTENERE LE ISTRUZIONI PER L'USO

>  [www](http://www.docs.whirlpool.eu) Scaricare le Istruzioni per l'uso dal sito web **docs.whirlpool.eu** (è possibile utilizzare questo codice QR) specificando il codice prodotto.



> In alternativa, contattare il Servizio di Assistenza Clienti.

CONTATTARE IL SERVIZIO ASSISTENZA CLIENTI

I contatti possono essere trovati sul manuale di garanzia. Prima di contattare il Servizio Assistenza, prepararsi a fornire i codici riportati sulla targhetta matricola del prodotto.

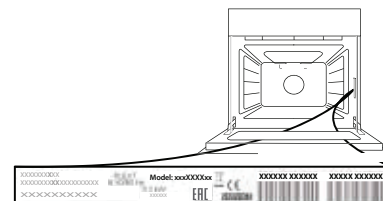

INSTRUCCIONES DE SEGURIDAD

Antes de usar el aparato, lea atentamente estas instrucciones de seguridad. Téngalas a mano para consultarlas más adelante.

Tanto estas instrucciones como el aparato contienen importantes advertencias de seguridad, que deben respetarse en todo momento. El fabricante declina cualquier responsabilidad derivada del incumplimiento de estas instrucciones de seguridad, del uso indebido del aparato o del ajuste incorrecto de los mandos.

⚠ Los niños muy pequeños (0-3 años) deben mantenerse alejados del aparato. Los menores de 8 años deben permanecer alejados del aparato a menos que estén supervisados en todo momento. Tanto los niños a partir de 8 años como las personas cuyas capacidades físicas, sensoriales o mentales estén disminuidas o que carezcan de la experiencia y conocimientos necesarios pueden utilizar este aparato si reciben la supervisión o las instrucciones necesarias para utilizarlo de forma segura y comprenden los riesgos a los que se exponen. Los niños no deben jugar con el aparato. Los niños no deben realizar tareas de limpieza o de mantenimiento sin supervisión.

⚠ **ADVERTENCIA:** El aparato y las partes accesibles se calientan durante el uso. Es necesario prestar atención para no tocar las resistencias. Mantenga alejados a los niños menores de 8 años salvo que sean supervisados continuamente.

⚠ No deje el aparato desatendido durante el secado de alimentos. Si el aparato está capacitado para utilizar la sonda, utilice solamente una sonda de temperatura recomendada para este horno.

⚠ Mantenga los paños y otros materiales inflamables alejados del aparato hasta que todos los componentes se hayan enfriado por completo; hay riesgo de incendio. Preste atención al horno siempre que cocine alimentos ricos en grasa, aceite o cuando añada alcohol, existe riesgo de incendio. Utilice guantes adecuados para sacar las bandejas y los accesorios. Cuando termine la cocción, abra la puerta con cuidado, permitiendo que el aire o vapor calientes salgan gradualmente antes de acceder a la cavidad; hay riesgo de quemarse. No obstruya las salidas de ventilación de la parte delantera del horno, existe riesgo de incendio.

⚠ Tenga cuidado de no chocar con la puerta del horno cuando esté abierta o bajada.

USO PERMITIDO

⚠ **PRECAUCIÓN:** El aparato no está diseñado para su uso con un temporizador externo o un sistema de mando a distancia.

⚠ Este aparato está destinado a un uso en ambientes domésticos o en ambientes similares como: áreas de

ES IMPORTANTE LEER Y RESPETAR ESTAS INSTRUCCIONES

cocina en oficinas, tiendas y otros; granjas; por los clientes de hoteles, moteles, hostales y otros entornos residenciales.

⚠ No se admite ningún otro uso (p. ej., calentar habitaciones).

⚠ Este aparato no es para uso profesional. No utilice este aparato al aire libre.

⚠ No guarde sustancias explosivas ni inflamables (como frascos de aerosoles o gasolina) dentro o cerca del aparato, ya que existe riesgo de incendio.

INSTALACIÓN

⚠ La manipulación e instalación del aparato la deben realizar dos o más personas; hay riesgo de lesionarse. Utilice guantes de protección para el desembalaje y la instalación, ya que existe riesgo de cortes.

⚠ La instalación, incluido el suministro de agua (si lo hay), las conexiones eléctricas y las reparaciones deben ser efectuadas por un técnico cualificado. No realice reparaciones ni sustituciones de partes del aparato no indicadas específicamente en el manual del usuario. Mantenga a los niños alejados del lugar de instalación. Tras desembalar el aparato, compruebe que no ha sufrido daños durante el transporte. Si observa algún problema, póngase en contacto con el distribuidor o el Servicio Postventa más cercano. Una vez instalado el aparato, mantenga los restos de embalaje (plásticos, piezas de poliestireno extruido, etc.) fuera del alcance de los niños, ya que existe riesgo de asfixia. El aparato debe desconectarse del suministro eléctrico antes de efectuar cualquier operación de instalación; hay riesgo de descarga eléctrica. Durante la instalación, compruebe que el aparato no dañe el cable de alimentación; hay riesgo de descarga eléctrica. No active el aparato hasta haberlo instalado por completo.

⚠ Realice todas las operaciones de corte de armarios antes de encostar el aparato y limpie todas las astillas y el serrín.

No obstruya el espacio mínimo entre la encimera y el borde superior del horno; hay riesgo de quemarse. No quite el horno de la base de poliestireno hasta el momento de la instalación.

⚠ Después de la instalación, la base del aparato no debe ser accesible; hay riesgo de quemarse.

⚠ No instale el aparato tras una puerta decorativa; hay riesgo de incendio.

ADVERTENCIAS SOBRE ELECTRICIDAD

⚠ La placa de datos se encuentra en el borde frontal del horno (visible con la puerta del horno abierta).

⚠ Debe ser posible desconectar el aparato de la alimentación eléctrica desenchufándolo si el enchufe es accesible o mediante un interruptor

omnipolar instalado antes del enchufe, de conformidad con las normativas de cableado y el aparato debe conectarse a una toma de tierra de acuerdo con las normativas de seguridad vigentes en materia de electricidad.

⚠ No utilice alargadores, regletas ni adaptadores. Una vez terminada la instalación, los componentes eléctricos no deberán quedar accesibles para el usuario. No utilice el aparato si está mojado o va descalzo. No use este aparato si tiene un cable o un enchufe de red dañado, si no funciona bien, o si se ha dañado o se ha caído.

⚠ Si el cable de alimentación está dañado, sólo debe sustituirlo por otro idéntico por el fabricante, personal cualificado del servicio de asistencia técnica del fabricante o similar para evitar daños; hay riesgo de descarga eléctrica.

⚠ Póngase en contacto con un Centro de Asistencia Técnica autorizado en caso de que tenga que sustituir el cable de alimentación.

LIMPIEZA Y MANTENIMIENTO

⚠ ADVERTENCIA: Asegúrese de que el aparato esté apagado y desconectado del suministro eléctrico antes de realizar cualquier operación de mantenimiento; no utilice aparatos de limpieza con vapor, hay riesgo de descarga eléctrica.

⚠ No utilice limpiadores abrasivos ni raspadores metálicos con bordes afilados para limpiar el cristal de la puerta ya que podrían arañar la superficie, lo que puede provocar que el cristal se rompa.

⚠ Antes de realizar operaciones de limpieza o mantenimiento, asegúrese de que se ha enfriado el aparato; hay riesgo de quemarse.

⚠ ADVERTENCIA: Apague el aparato antes de sustituir la lámpara; hay riesgo de descarga eléctrica.

ELIMINACIÓN DEL MATERIAL DE EMBALAJE

El material de embalaje es 100% reciclable y está marcado con el símbolo de reciclaje .

Por lo tanto, deberá desechar las diferentes piezas del embalaje de forma responsable, respetando siempre las normas locales sobre eliminación de residuos.

ELIMINACIÓN DE LOS ELECTRODOMÉSTICOS

Este aparato ha sido fabricado con material reciclable o reutilizable. Debe desecharse de acuerdo con la normativa local al respecto. Para obtener información más detallada sobre el tratamiento, recuperación y reciclaje de electrodomésticos, póngase en contacto con las autoridades locales, con el servicio de recogida de residuos domésticos, o con la tienda en la que adquirió el aparato. Este electrodoméstico lleva el marcado CE de conformidad con la Directiva Europea 2012/19/UE sobre Residuos de Aparatos Eléctricos y Electrónicos (RAEE) y con la normativa de Residuos de Aparatos Eléctricos y Electrónicos de 2013 (modificada). La correcta eliminación de este producto evita consecuencias negativas para el medio ambiente y la salud.

El símbolo  que se incluye en el aparato o en la documentación que lo acompaña indica que no debe tratarse como un residuo doméstico, sino que debe entregarse en un punto de recogida adecuado para el reciclado de aparatos eléctricos y electrónicos.

CONSEJOS PARA AHORRAR ENERGÍA

Precaliente el horno solamente si así se especifica en la tabla de cocción o en la receta. Utilice bandejas pasteleras lacadas o esmaltadas oscuras, ya que absorben mejor el calor. Los alimentos que requieren una cocción prolongada se siguen cocinando incluso después del apagado del horno.

DECLARACIÓN DE DISEÑO ECOLÓGICO

Este aparato cumple con: los requisitos de diseño ecológico del Reglamento europeo n.º 66/2014; el Reglamento sobre etiquetado energético 65/2014; el Reglamento de diseño ecológico aplicable a los productos relacionados con la energía y el Reglamento sobre la información energética (enmienda) (salida de la UE) de 2019, en cumplimiento con la norma europea EN 60350-1.

GUÍA DE CONSULTA DIARIA



GRACIAS POR COMPRAR UN PRODUCTO WHIRLPOOL

Si desea recibir asistencia y soporte adicionales, registre su producto en www.whirlpool.eu/register



Puede descargarse las Instrucciones de seguridad y la Guía de uso y cuidado en nuestro sitio web docs.whirlpool.eu y siguiendo las instrucciones del dorso de este folleto.



Antes de usar el producto, lea atentamente las instrucciones de seguridad.

DESCRIPCIÓN DEL PRODUCTO

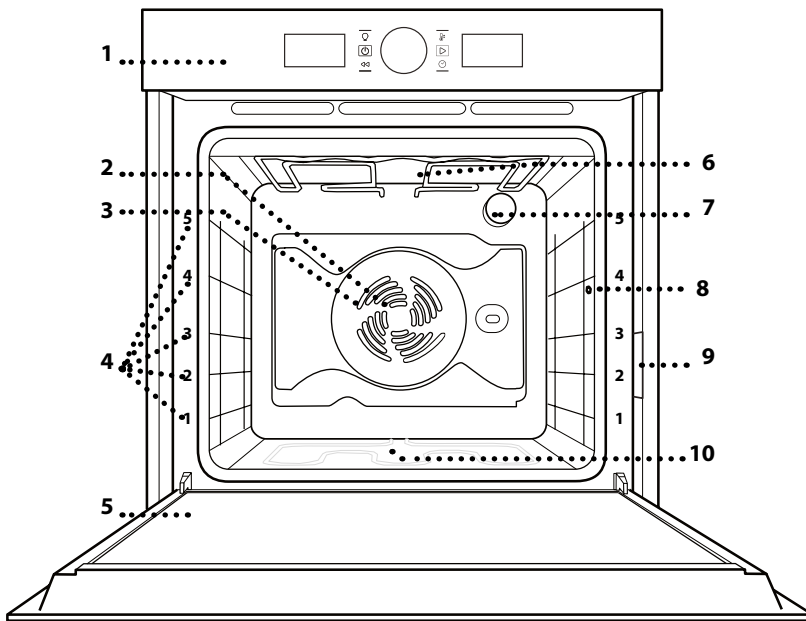

1. Panel de control
2. Ventilador
3. Resistencia circular (no visible)
4. Guías para estantes (el nivel está indicado en la parte frontal del horno)
5. Puerta
6. Resistencia superior / grill
7. Lámpara
8. Punto de inserción de la sonda para carne (si la hay)
9. Placa de características (no debe retirarse)
10. Resistencia inferior (no visible)

PANEL DE CONTROL

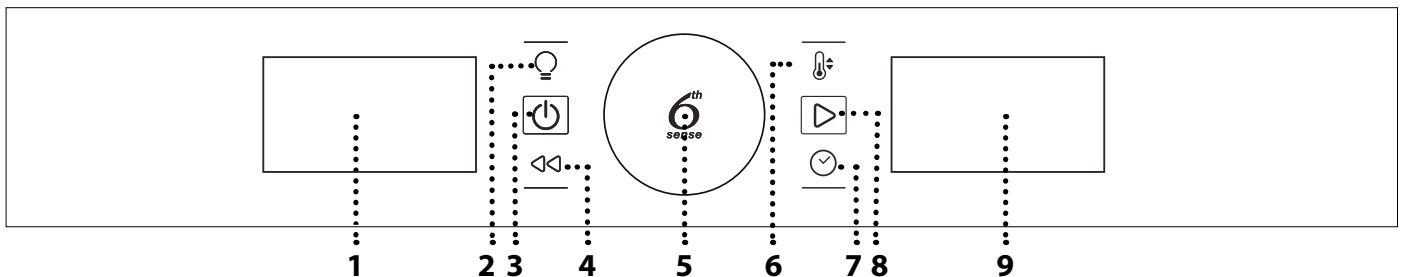

1. PANTALLA DE LA IZQUIERDA

2. LUZ

Para encender/apagar la bombilla.

3. ENCENDER/APAGAR

Para encender o apagar el horno y para detener una función activa en cualquier momento.

4. VOLVER

Para volver al menú de configuración anterior cuando se configuren los ajustes.

5. SELECTOR ROTATIVO / BOTÓN 6TH SENSE

Gírelo para moverse por las funciones y programar todos los parámetros de cocción. Pulse  para seleccionar, programar, acceder o confirmar las funciones o parámetros, y, eventualmente, para iniciar el programa de cocción.

6. TEMPERATURA

Para ajustar la temperatura.

7. TIEMPO

Para configurar o cambiar la hora y ajustar el tiempo de cocción.

8. INICIO

Para iniciar funciones y confirmar los ajustes.

9. PANTALLA DE LA DERECHA

ACCESORIOS

REJILLA

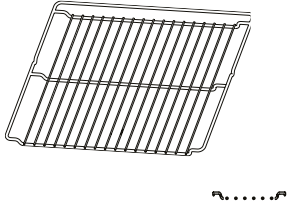

GRASERA

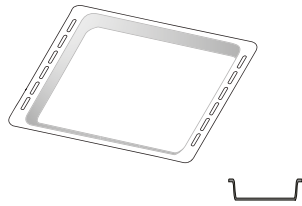

BANDEJA PASTELERA

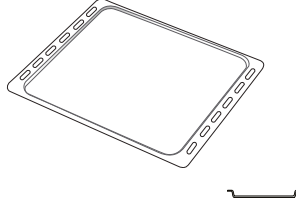

GUÍAS DESLIZANTES (SOLO EN ALGUNOS MODELOS)

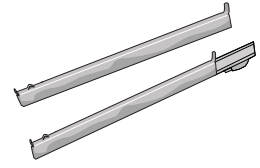

SONDA DE CARNE (SOLO EN ALGUNOS MODELOS)

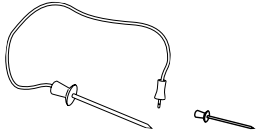

El número de accesorios puede variar de un modelo a otro. Se pueden adquirir otros accesorios por separado en el Servicio Postventa.

INTRODUCCIÓN DE LA REJILLA Y OTROS ACCESORIOS

Introduzca la rejilla horizontalmente deslizándola a través de las guías y asegúrese de que el lado con el borde en relieve queda mirando hacia arriba.

Otros accesorios, como la grasera y la bandeja pastelera, se introducen horizontalmente igual que la rejilla.

MONTAJE DE LAS GUÍAS DESLIZANTES (SI PROCEDE)

Extraiga las guías para los estantes del horno y quite el plástico de protección de las guías deslizantes.

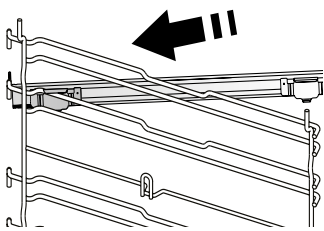

Fije el cierre superior de la corredera a la guía para los estantes y deslícela hasta el tope. Baje el otro clip a su posición.

Para fijar la guía, empuje la parte inferior del cierre contra la guía para estantes. Asegúrese de que las guías se pueden mover libremente. Repita estos pasos en la otra guía para estantes del mismo nivel.

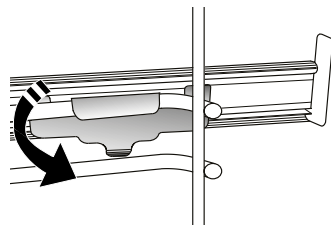

Nota: Las guías deslizantes se pueden montar en cualquier nivel.

CÓMO EXTRAER Y VOLVER A COLOCAR LAS GUÍAS PARA ESTANTES

Véanse las figuras para extraer los soportes laterales y (si las hubiera) las tuercas que las fijan en el interior del horno.

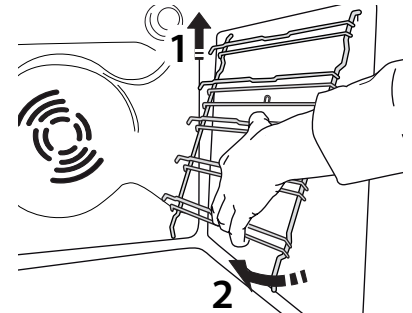
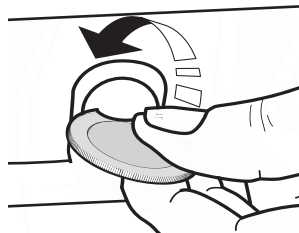
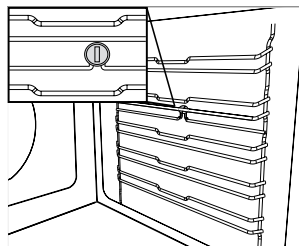

Para volver a colocar las guías para estantes, encájelas primero en su alojamiento superior. Manteniéndolas en alto, deslícelas en el compartimento de cocción, y luego bájelas hasta colocarlas en el alojamiento inferior.

FUNCIONES



CONVENCIONAL

Para cocinar cualquier tipo de alimento en un estante.



GRILL

Para asar filetes, pinchos morunos y salchichas, cocinar verduras al gratín o tostar pan. Cuando ase carne, le recomendamos colocar la grasa debajo para recoger los jugos de la cocción: Coloque la bandeja en cualquiera de los niveles debajo de la rejilla y añada 500 ml de agua potable.



AIRE FORZADO

Para cocinar diferentes tipos de alimentos que requieran la misma temperatura de cocción en diferentes estantes (máximo tres) al mismo tiempo. Esta función puede utilizarse para cocinar diferentes alimentos sin que se mezclen los olores.



HORNO DE CONVECCIÓN

Para cocinar carne, hornear tartas con relleno o asar verduras rellenas en un único estante. Esta función utiliza una circulación del aire suave e intermitente para que los alimentos no se sequen en exceso.



FUNCIONES 6TH SENSE



CAZUELA

Esta función selecciona automáticamente la mejor temperatura y el mejor método de cocción para los platos de pasta.



CARNE

Esta función selecciona automáticamente la mejor temperatura y el mejor método de cocción para la carne. Esta función activa el ventilador de forma intermitente y a velocidad baja para evitar que los alimentos se sequen demasiado.



MAXI-COCCIÓN

Esta función selecciona automáticamente la mejor forma de cocción y temperatura para cocinar una gran cantidad de carne (más de 2,5 kg). Se recomienda dar la vuelta a los alimentos durante la cocción para obtener un resultado homogéneo por ambos lados. Se recomienda untar la carne periódicamente con su propio jugo para que no se seque en exceso.



PAN

Esta función selecciona automáticamente la mejor temperatura y el mejor método de cocción para todos los tipos de pan.



PIZZA

Esta función selecciona automáticamente la mejor temperatura y el mejor método de cocción para todos los tipos de pizza.



TARTAS DULCES

Esta función selecciona automáticamente la mejor temperatura y el mejor método de cocción para todos los tipos de tarta.



FUNCIONES DE COCCIÓN ESPECIALES



PRECALENTAMIENTO RÁPIDO

Para precalentar el horno rápidamente. Una vez finalizado el precalentamiento, el horno utilizará automáticamente la función «Convencional». Espere a que termine el precalentamiento antes de introducir los alimentos en el horno.



TURBO GRILL

Para asar grandes piezas de carne (pierna de cordero, rosbif, pollo). Le recomendamos utilizar la grasa para recoger los jugos de la cocción: Coloque el recipiente en cualquiera de los niveles debajo de la rejilla y añada 500 ml de agua potable. El asador giratorio (si lo hay) puede utilizarse con esta función.



ECO AIRE FORZADO*

Para cocinar piezas de carne asadas con relleno y filetes de carne en un solo estante. Para evitar que los alimentos se resequen, el aire circula de manera suave e intermitente. Cuando se utiliza esta función ECO, la luz permanece apagada durante la cocción. Para utilizar el ciclo ECO y optimizar el consumo de energía, la puerta del horno no se debe abrir hasta que termine la cocción.



MANTENER CALIENTE

Para mantener calientes y crujientes los alimentos recién cocinados.



LEUDADO

Para optimizar la fermentación de masas dulces o saladas. Para garantizar la calidad del leudado, no active la función si el horno está caliente después de un ciclo de cocción.



SMART CLEAN

(SOLO EN ALGUNOS MODELOS)

La acción del vapor liberado durante este ciclo especial de limpieza a baja temperatura permite eliminar la suciedad y los residuos de alimentos con facilidad. Vierta 200 ml de agua potable en el fondo del horno y active la función únicamente cuando el horno esté frío.

* Función utilizada como referencia para la declaración de eficiencia energética de conformidad con la normativa (EU) N° 65/2014

PRIMER USO

1. CÓMO CONFIGURAR LA HORA

La primera vez que encienda el aparato, tendrá que ajustar la hora.



Los dos dígitos de la hora empezarán a parpadear: Gire el selector para establecer la hora y pulse para confirmar.



Los dos dígitos de los minutos empezarán a parpadear. Gire el selector para establecer los minutos y pulse para confirmar.

Nota: Para cambiar la hora más adelante, mantenga pulsado durante como mínimo un segundo con el horno apagado y repita el procedimiento anterior.

Después de un corte de suministro prolongado, es posible que tenga que volver configurar la hora.

2. CONFIGURACIÓN

Si es necesario, puede cambiar la unidad de medida, la temperatura (°C) y la corriente nominal (16 A) predeterminadas.

Con el horno apagado, mantenga pulsado durante al menos 5 segundos.



Gire el selector para seleccionar la unidad de medida y pulse para confirmar.



Gire el selector para seleccionar la corriente nominal y pulse para confirmar.

Nota: El horno está programado para consumir un nivel de potencia eléctrica compatible con el de una red doméstica que tenga una potencia superior a 3 kW (16 A): Si su hogar tiene menos potencia, deberá reducir este valor (13 A).

3. CALENTAR EL HORNO

Un horno nuevo puede liberar olores que se han quedado impregnados durante la fabricación: es completamente normal.

Antes de empezar a cocinar, le recomendamos calentar el horno en vacío para eliminar cualquier olor.

Quite todos los cartones de protección o el film transparente del horno y saque todos los accesorios de su interior.

Caliente el horno a 200 °C aproximadamente durante una hora, preferiblemente utilizando la función con circulación del aire (p. ej. "Aire forzado" u "Horno de Convección").

Siga las instrucciones para configurar la función correctamente.

Nota: Es aconsejable ventilar la habitación después de usar el aparato por primera vez.

USO DIARIO

1. SELECCIONAR UNA FUNCIÓN

Cuando el horno está apagado, la pantalla solo muestra la hora. Mantenga pulsado para encender el horno. Gire el selector para ver las funciones principales disponibles en la pantalla de la izquierda. Seleccione una y pulse .



Para seleccionar una subfunción (en caso de que la haya), seleccione la función principal y después pulse para confirmar e ir al menú de la función.



Gire el selector para ver las subfunciones disponibles en la pantalla de la izquierda. Seleccione una y pulse para confirmar.

2. AJUSTAR LA FUNCIÓN

Cuando haya seleccionado la función que desee, puede cambiar la configuración correspondiente. En la pantalla aparecerá la configuración que se puede cambiar por orden.

TEMPERATURA/NIVEL DE GRILL



Cuando el icono °C/°F parpadee en la pantalla, gire el selector para cambiar el valor y después pulse para confirmar y continuar con la modificación de ajustes siguiente (si es posible).

También se puede ajustar el nivel del grill (3 = alto, 2 = medio, 1 = bajo) al mismo tiempo.



Nota: Una vez iniciada la función, puede cambiar la temperatura o el nivel del grill pulsando o girando el selector directamente.

DURACIÓN



Cuando parpadee el icono en la pantalla, utilice el selector de ajuste para ajustar el tiempo de cocción necesario y luego pulse para confirmar.

Si quiere cocinar de forma manual no es necesario configurar el tiempo de cocción: Pulse para confirmar e iniciar la función.

En este caso, no puede configurar la hora de finalización de la cocción programando un inicio diferido.

Nota: Pulse para ajustar el tiempo de cocción establecido: Gire el selector para cambiar la hora y pulse para confirmar.

SELECCIONAR LA HORA DE FINALIZACIÓN DE LA COCCIÓN / INICIO DIFERIDO

En muchas funciones, una vez configurado el tiempo de cocción, podrá retrasar el inicio de la función programando la hora de finalización.

Cuando pueda cambiar la hora de finalización, la pantalla mostrará la hora a la que terminará la cocción y el icono parpadeará.



Si es necesario, gire el selector para configurar la hora a la que quiere que termine la cocción y pulse para confirmar e iniciar la función.

Coloque los alimentos en el horno y cierre la puerta: Esta función se iniciará automáticamente cuando haya transcurrido el periodo de tiempo calculado para que la cocción termine a la hora programada.



Nota: Programar una cocción con inicio diferido deshabilitará la fase de precalentamiento del horno. El horno alcanzará la temperatura deseada de forma gradual, por lo que los tiempos de cocción serán ligeramente superiores a los de la tabla de cocción.

Durante el tiempo de espera, puede usar el selector para cambiar la hora de finalización programada.

Pulse o para cambiar los ajustes de temperatura y tiempo de cocción. Pulse para confirmar cuando acabe.

Nota: La función de inicio retardado no está disponible para las funciones Grill y Turbo Grill.

3. ACTIVAR LA FUNCIÓN

Una vez que haya aplicado la configuración deseada, pulse para activar la función.

Puede mantener pulsado en cualquier momento para poner en pausa la función que esté activada en ese momento.

4. PRECALENTAMIENTO

Algunas funciones incluyen una fase de precalentamiento de horno: Una vez iniciada la función, la pantalla indica que se ha activado la fase de precalentamiento.



Cuando el precalentamiento haya terminado, sonará una señal acústica y la pantalla indicará que el horno ha alcanzado la temperatura establecida.



En ese momento, abra la puerta, introduzca los alimentos en el horno y cierre para iniciar la cocción pulsando .

Nota: colocar los alimentos en el horno antes de que haya finalizado el precalentamiento puede tener efectos adversos en el resultado final de la cocción.

Abrir la puerta durante la fase de precalentamiento pondrá en pausa el proceso.

El tiempo de cocción no incluye la fase de precalentamiento.

La temperatura deseada se puede cambiar en cualquier momento utilizando el selector.

5. FINAL DE COCCIÓN

Sonará una señal acústica y la pantalla indicará que la cocción ha terminado.



Para alargar el tiempo de cocción sin cambiar los ajustes, gire el selector para programar un nuevo tiempo de cocción y pulse .

. FUNCIONES 6th SENSE

RECUPERACIÓN DE LA TEMPERATURA

Si la temperatura interior del horno baja durante un ciclo de cocción por tener la puerta abierta, se activará una función especial automáticamente para recuperar la temperatura original. Mientras se recupere la temperatura, la pantalla mostrará una animación en "serpiente" hasta que se alcance la temperatura.

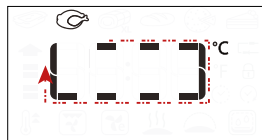

Cuando un ciclo de cocción programado esté en progreso, el tiempo de cocción aumentará dependiendo del tiempo que la puerta haya estado abierta para garantizar un resultado óptimo.

. FUNCIONES ESPECIALES

SMART CLEAN

Para activar la función «Smart Clean», con el horno frío, distribuya 200 ml de agua en el fondo de la cavidad del horno y cierre la puerta.

Acceda a las funciones especiales y gire el selector para seleccionar del menú. Luego, pulse para confirmar.

Pulse para iniciar inmediatamente el ciclo de limpieza, o pulse para establecer el tiempo final/inicio diferido.

Al final del ciclo, deje que el horno se enfríe, elimine el agua que pueda quedar en el horno y efectúe la limpieza con una esponja humedecida en agua caliente (si retrasa esta operación más de 15 minutos, podría comprometer el resultado de la limpieza).

Nota: La duración y la temperatura del ciclo de limpieza no se pueden programar.

. USO DE LA Sonda PARA CARNE (SI LA HAY)

La sonda para carne incluida con el horno permite medir con exactitud la temperatura interna del alimento durante la cocción.

La sonda de carne solamente se puede utilizar en algunas funciones de cocción (Convencional, Aire forzado, Horno de convección, Turbo Grill, Carne 6th Sense y Maxi cocción 6th Sense).

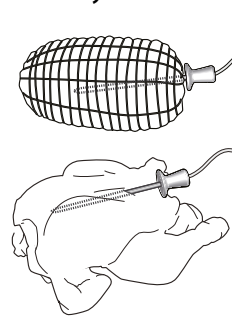

Es muy importante colocar la sonda con precisión para obtener resultados de cocción óptimos. Introduzca la sonda completamente en la parte más carnosa, evitando huesos y zonas de grasa. En el caso de las aves, la sonda debería introducirse de forma transversal, en el centro de la pechuga, asegurándose de que la punta no termine en una zona hueca. En el caso de carnes con

grosos muy irregulares, compruebe que estén correctamente cocinadas antes de sacarlas del horno. Conecte la punta de la sonda en el orificio situado en la pared derecha de la cavidad del horno.

Una vez que la sonda para carne esté conectada a la cavidad del horno, emitirá una señal acústica y en la pantalla aparecerán el icono y la temperatura programada.

Si la sonda para carne está conectada durante la selección de una función, la pantalla conmuta al valor de temperatura por defecto de la sonda para carne.



Pulse para iniciar los ajustes. Gire el selector para programar la temperatura prevista para la sonda para carne. Pulse para confirmar. Gire el selector para programar la temperatura del interior del horno.



Pulse o para confirmar e iniciar el ciclo de cocción.

Durante el ciclo de cocción, la pantalla muestra la temperatura programada para la sonda de la carne. Cuando la carne alcanza la temperatura programada, el ciclo de cocción se detiene y en la pantalla aparece la palabra «End» (Fin).

Se puede reanudar el ciclo de cocción desde «End» girando el selector para ajustar la temperatura prevista para la sonda de la carne como se indica arriba. Pulse o para confirmar y reanudar el ciclo de cocción.

Nota: durante el ciclo de cocción con la sonda para carne puede girar el selector para modificar la temperatura prevista para la sonda. Pulse para ajustar la temperatura del interior del horno.

La sonda para carne se puede introducir en cualquier momento, incluso durante el ciclo de cocción. En este caso, será necesario reprogramar los parámetros de la función de cocción.

Si la sonda para carne es incompatible con una función, el horno apagará el ciclo de cocción y emitirá un sonido de alerta. En este caso, deberá desconectar la sonda para carne o pulsar para configurar otra función. El inicio diferido y la fase de precalentado no son compatibles con la sonda para carne.

. BLOQUEO DE TECLAS

Para bloquear las teclas, mantenga pulsado durante al menos 5 segundos.



Para desbloquearlo, siga el mismo proceso.

Nota: El bloqueo de teclas también se puede activar mientras la cocción esté en proceso.

Por motivos de seguridad, puede apagar el horno en cualquier momento pulsando el botón .

CONSEJOS ÚTILES

CÓMO UTILIZAR LA TABLA DE COCCIÓN

La tabla indica la mejor función, accesorios y nivel para cocinar los diferentes tipos de alimentos. Los tiempos de cocción inician en el momento en que se coloca el alimento en el horno, excluyendo el precalentamiento (cuando sea necesario). Las temperaturas y los tiempos de cocción son orientativos y dependen de la cantidad de alimentos y del tipo de accesorio utilizado. En principio, aplique los valores de ajuste recomendados más bajos y, si la cocción no es suficiente, aumentelos. Utilice los accesorios suministrados y, si es posible, moldes y bandejas pasteleras metálicas de color oscuro. También puede utilizar recipientes y accesorios tipo pírex o de cerámica, aunque deberá tener en cuenta que los tiempos de cocción serán ligeramente mayores.

COCCIÓN DE VARIOS ALIMENTOS A LA VEZ

El uso de la función «Aire forzado» permite cocinar al mismo tiempo distintos alimentos que requieran la misma temperatura (por ejemplo: pescado y verduras), utilizando estantes diferentes. Retire del horno los alimentos que requieran menor tiempo de cocción y deje los que necesiten una cocción más prolongada.

CARNE

Utilice cualquier tipo de bandeja de horno o fuente pírex adecuado al tamaño de la pieza de carne que va a cocinar. En el caso de asados, es conveniente añadir caldo a la base de la bandeja y rociar la carne durante la cocción para realzar el sabor. Durante esta operación se generará vapor. Cuando el asado esté listo, déjelo reposar en el horno durante 10 o 15 minutos, o envuélvalo en papel de aluminio.

Cuando desee gratinar carne, elija cortes de carne de igual grosor para obtener un resultado de cocción uniforme. Las piezas de carne muy gruesas requieren tiempos de cocción más prolongados. Para evitar que la carne se queme por fuera, coloque la rejilla en un estante inferior para alejarla del grill. Gire la carne en el segundo tercio del tiempo de cocción. Abra la puerta con cuidado, ya que puede salir vapor caliente.

Para recoger los jugos de la cocción, es conveniente colocar una grasera con medio litro de agua directamente debajo de la rejilla en la que se coloque la carne. Reponga el líquido cuando sea necesario.

POSTRES

Cocine los postres delicados con la función convencional y en un solo nivel.

Utilice bandejas para hornear metálicas de color oscuro y colóquelas siempre sobre la rejilla suministrada. Para cocinar en varios estantes, seleccione la función de aire forzado y disponga los moldes en ellos de modo que la circulación de aire caliente sea óptima.

Para saber si un bizcocho está listo, introduzca un palillo en el centro. Si al retirar el palillo está limpio, el bizcocho está listo.

Si utiliza bandejas para hornear antiadherentes, no unte con mantequilla los bordes, ya que es posible que el bizcocho no suba de manera uniforme por los bordes.

Si el producto se «hincha» durante la cocción, use una temperatura más baja la próxima vez y plantéese reducir la cantidad de líquido añadido o remover la mezcla más suavemente.

Para postres con relleno húmedo (tartas de queso o de fruta) utilice la función «Horno de convección». Si la base del bizcocho o tarta está demasiado líquida, coloque la bandeja en un estante inferior y espolvoree galletas o pan rallado en la base antes de añadir el relleno.

















































































PIZZA

Engrase ligeramente las bandejas para que la pizza tenga una base crujiente. Esparza la mozzarella sobre la pizza en el segundo tercio del tiempo de cocción.

LEUDADO DE MASAS

Es conveniente cubrir siempre la masa con un paño húmedo antes de introducirla en el horno. Al utilizar esta función, el tiempo de fermentación de la masa se reduce en un tercio con respecto al tiempo de fermentación a temperatura ambiente (20-25 °C). El tiempo de leudado de una pizza de 1 kg es de alrededor de una hora.

TABLA DE COCCIÓN

RECETA	FUNCIÓN	PRECALENTAR	TEMPERATURA (°C)	TIEMPO COCCIÓN (Min.)	NIVEL Y ACCESORIOS
Bizcochos		-	170	30 - 50	2 
		Sí	160	30 - 50	2 
		Sí	160	30 - 50	4 1  
Bizcocho relleno (tarta de queso, pasteles de hojaldre relleno, tarta de manzana)		-	160 - 200	30 - 85	3 
		Sí	160 - 200	35 - 90	4 1  
Galletas / Pastelitos		-	160 - 170	20 - 40	3 
		Sí	150 - 160	20 - 40	3 
		Sí	150 - 160	20 - 40	4 1  
Lionesas		-	180 - 200	30 - 40	3 
		Sí	180 - 190	35 - 45	4 1  
		Sí	180 - 190	35 - 45*	5 3 1   
Merengues		Sí	90	110 - 150	3 
		Sí	90	130 - 150	4 1  
		Sí	90	140 - 160*	5 3 1   
Pizza (Fina, gruesa, focaccia)		-	220-250	20 - 40	2 
		Sí	220 - 240	20 - 40	4 1  
		Sí	220 - 240	25 - 50*	5 3 1   
Pan de molde 0,5 kg		-	180 - 220	50-70	2 
Panecillo		-	180 - 220	30 - 50	3 
Pan		Sí	180 - 220	30-60	4 1  
Pizza congelada		-	250	10 - 20	2 
		Sí	250	10 - 20	4 1  
Tartas saladas (tarta de verduras, quiche)		Sí	180 - 190	45 - 60	2 
		Sí	180 - 190	45 - 60	4 1  
		Sí	180 - 190	45 - 70*	5 3 1   
Volovanes/Canapés de hojaldre		Sí	190 - 200	20 - 30	3 
		Sí	180 - 190	20 - 40	4 1  
		Sí	180 - 190	20 - 40*	5 3 1   
Lasañas, Pasteles		-	190 - 200	40 - 65	3 
Pasta al horno, Canelones		-	190 - 200	25 - 45	3 

RECETA	FUNCIÓN	PRECALENTAR	TEMPERATURA (°C)	TIEMPO COCCIÓN (Min.)	NIVEL Y ACCESORIOS
Cordero/ternera/buey/cerdo 1 kg		-	190 - 200	60-90	3
Cerdo asado con torreznos 2 kg		-	170	110 - 150	2
Pollo/conejo/pato 1 kg		-	200-230	50 - 80 **	3
Pavo/oca 3 kg		-	190 - 200	90-150	2
Pescado al horno / en papillote (filetes, entero)		Sí	180 - 200	40 - 60	3
Verduras rellenas (tomates, calabacines, berenjenas)		Sí	180 - 200	50 - 60	2
Tostada		-	3 (Alta)	3 - 6	5
Filetes de pescado/de carne		-	2 (Medio)	20 - 30***	4 3
Salchichas/brochetas/costillas/hamburguesas		-	2 - 3 (Medio - Alto)	15 - 30***	5 4
Pollo asado 1-1,3 kg		-	2 (Medio)	55 - 70**	2 1
Asado de ternera poco hecho (1 kg)		-	2 (Medio)	35 - 50**	3
Pierna de cordero/cerdo		-	2 (Medio)	60 - 90**	3
Patatas al horno		-	2 (Medio)	35 - 55**	3
Verduras gratinadas		-	3 (Alta)	10-25	3
Menú completo: Tarta de frutas (nivel 5)/ lasaña (nivel 3)/ carne (nivel 1)		Sí	190	40 - 120*	5 3 1
Lasañas y carnes		Sí	200	50 - 120*	4 1
Carnes y patatas		Sí	200	45 - 120*	4 1
Pescado y verduras		Sí	180	30 - 50	4 1
Piezas de carne rellenas asadas		-	200	80-120*	3
Cortes de carne (conejo, pollo, cordero)		-	200	50 - 120*	3

* Tiempo de cocción estimado: Los platos se pueden extraer del horno antes o después según los gustos personales.

** Darle la vuelta al alimento en el segundo tercio de la cocción (si fuera necesario).

*** Dar la vuelta al alimento a mitad de la cocción

Nota: La función de 6th Sense «Tartas dulces» solamente utiliza las resistencias superior e inferior, sin circulación forzada del aire. No requiere precalentamiento.

FUNCIONES						
	Convencional	Grill	Turbo Grill	Aire forzado	Horno de convección	Eco aire forzado
FUNCIONES AUTOMÁTICAS						
	Cazuela	Carne	Maxi-cocción	Pan	Pizza	Tartas dulces
ACCESORIOS						
	Rejilla	Bandeja de horno o molde sobre rejilla	Grasera / bandeja pastelera o bandeja de horno sobre rejilla	Grasera / Bandeja pastelera	Bandeja de goteo con 500 ml de agua	

LIMPIEZA Y MANTENIMIENTO

Asegúrese de que el horno se haya enfriado antes de llevar a cabo las tareas de mantenimiento o limpieza.

No utilice aparatos de limpieza con vapor.

No utilice estropajos de acero, estropajos abrasivos ni productos de limpieza abrasivos/corrosivos, ya que podrían dañar las superficies del aparato.

Utilice guantes de protección.

El horno debe desconectarse de la red eléctrica antes de llevar a cabo cualquier trabajo de mantenimiento.

SUPERFICIES EXTERIORES

- Limpie las superficies con un paño húmedo de microfibra. Si están muy sucias, añada unas gotas de detergente neutro al agua. Seque con un paño seco.
- No utilice detergentes corrosivos ni abrasivos. Si uno de esos productos entra accidentalmente en contacto con la superficie del aparato, límpielo de inmediato con un paño húmedo de microfibra.

SUPERFICIES INTERIORES

- Después de cada uso, deje que el horno se enfríe y, a continuación, límpielo, preferiblemente cuando aún esté tibio, para quitar los restos o las manchas causados por los residuos de los alimentos. Para secar la condensación que se haya podido formar debido a la cocción de alimentos con un alto contenido en agua, deje que el horno se enfríe por completo y límpielo con un paño o esponja.

- Limpie el cristal de la puerta con un detergente líquido adecuado.
- Active la función «Smart Clean» para unos resultados de limpieza óptimos de las superficies internas (si la hay).
- Para limpiar el horno con facilidad, quite la puerta.
- La resistencia superior del grill se puede bajar para limpiar el panel superior del horno.

ACCESORIOS

Después del uso, sumerja los accesorios en una solución líquida con detergente, utilizando guantes si aún están calientes. Los residuos de alimentos pueden quitarse con un cepillo o esponja.

LIMPIEZA DE LOS PANELES CATALÍTICOS

(SOLO EN ALGUNOS MODELOS)

El horno está equipado con paneles catalíticos especiales que facilitan la limpieza de los compartimentos gracias a su capa especial de autolimpieza, que es muy porosa y absorbe la grasa y la suciedad.

Estos paneles están fijados a las guías para estantes. Al volver a colocar y fijar las guías para estantes, asegúrese de que los ganchos superiores quedan introducidos dentro de los agujeros adecuados de los paneles.

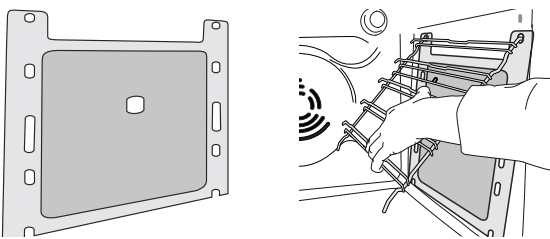

Para sacar el máximo partido a las propiedades de autolimpieza de los paneles catalíticos, recomendamos que caliente el horno a 200 °C durante aproximadamente una hora utilizando la función «Horno de convección». Durante este tiempo, el horno debe permanecer vacío.

Deje que el aparato se enfríe antes de eliminar los residuos de alimentos con una esponja no abrasiva.

Nota: El uso de detergentes corrosivos o abrasivos, cepillos duros, estropajos para ollas y esprays para horno puede dañar la superficie catalítica y poner en peligro sus propiedades de autolimpieza.

Póngase en contacto con el Servicio Postventa si necesita paneles de recambio.

CAMBIO DE LA BOMBILLA

1. Desconecte el horno de la red eléctrica.
2. Desenrosque la tapa de la lámpara, sustituya la bombilla y vuelva a enroscar la tapa de la lámpara.
3. Vuelva a conectar el horno a la red eléctrica.

Nota: Utilice solo bombillas halógenas de 20-40W/230V tipo G9, T300 °C. La bombilla que se usa en el aparato está diseñada específicamente para electrodomésticos y no es adecuada para la iluminación general de estancias en una vivienda (Normativa CE 244/2009). Las bombillas están disponibles en nuestro Servicio Postventa.

- Si utiliza lámparas halógenas, no las toque con las manos desnudas ya que las huellas dactilares podrían dañarlas. No utilice el horno hasta que no haya vuelto a colocar la tapa de la bombilla. Este producto incluye una fuente de luz con una clase de eficiencia energética G.

BAJE LA RESISTENCIA SUPERIOR
(SOLO EN ALGUNOS MODELOS)

1. Extraiga las guías laterales para estantes.

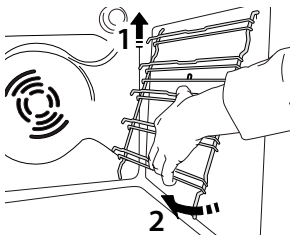

2. Extraiga ligeramente la resistencia y bájela.

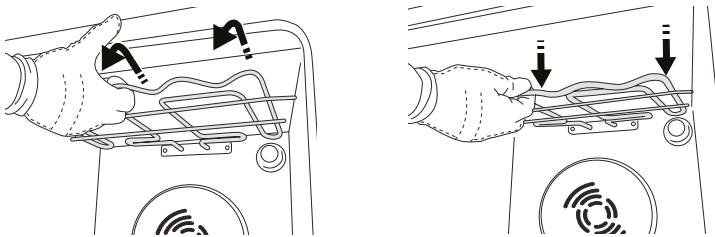

3. Para volver a situar la resistencia en su posición, elevarla, tirar de ella ligeramente hacia fuera y comprobar que queda apoyada en las sujeciones laterales.

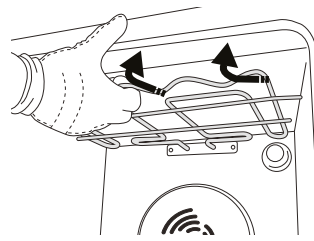

EXTRACCIÓN E INSTALACIÓN DE LA PUERTA

1. Para quitar la puerta, ábrala por completo y baje los pestillos hasta que estén en posición desbloqueada.

2. Cierre la puerta tanto como pueda. Sujete bien la puerta con las dos manos; no la sujete por el asa.

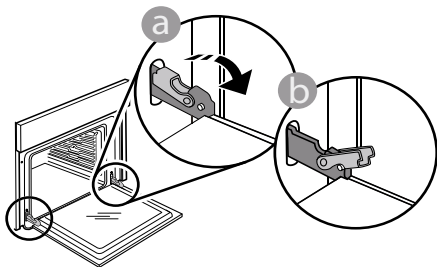

Simplemente extraiga la puerta continuando cerrándola y a la vez levantándola hasta que se salga de su alojamiento. Ponga la puerta en un lado, apoyada sobre una superficie blanda.

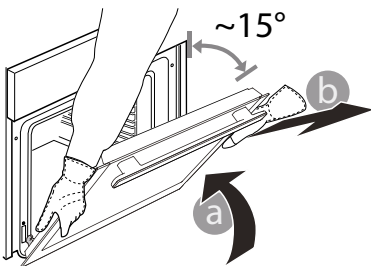

3. Vuelva a instalar la puerta llevándola hacia el horno, alineando los ganchos de las bisagras con sus alojamientos y fijando la parte superior en su alojamiento.

4. Baje la puerta y ábrala por completo. Baje los pestillos a su posición original: Asegúrese de haberlos bajado por completo.

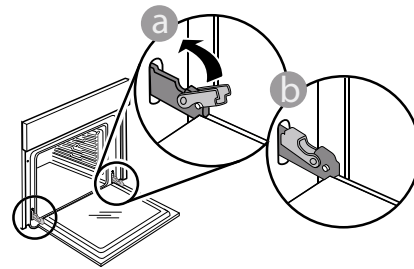

Presione suavemente para comprobar que los pestillos estén en la posición correcta.

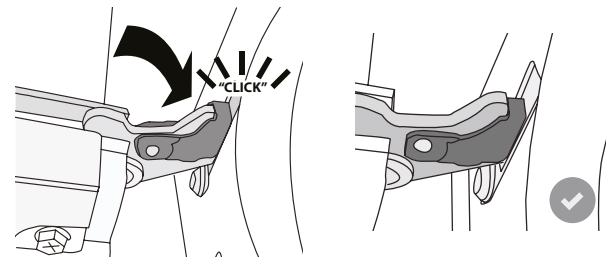

5. Intente cerrar la puerta y compruebe que está alineada con el panel de control. Si no lo está, repita los pasos de arriba: La puerta podría dañarse si no funciona correctamente.

RESOLUCIÓN DE PROBLEMAS

Problema	Posible causa	Solución
El horno no funciona.	Corte de suministro. Desconexión de la red eléctrica.	Compruebe que haya corriente eléctrica en la red y que el horno esté enchufado a la toma de electricidad. Apague el horno y vuelva a encenderlo para comprobar si se ha solucionado el problema.
En la pantalla aparecerá la letra «F» seguida de un número o letra.	Problema de software.	Póngase en contacto con el Servicio Postventa más cercano e indique el número que aparece detrás de la letra «F».
La pantalla muestra un texto poco claro y parece estar rota.	Otro idioma configurado.	Póngase en contacto con el Centro de atención al cliente más cercano

TARJETA DE DATOS DEL PRODUCTO

 docs.whirlpool.eu La ficha del producto con los datos de energía de este aparato se puede descargar en el sitio web de Whirlpool docs.whirlpool.eu

CÓMO OBTENER LA GUÍA DE USO Y CUIDADO

>  docs.whirlpool.eu Descargue la Guía de uso y cuidado en nuestra página web docs.whirlpool.eu (puede utilizar este código QR), especificando el código comercial del producto.



> También puede ponerse en contacto con nuestro Servicio Postventa.

CÓMO PONERSE EN CONTACTO CON NUESTRO SERVICIO POSTVENTA

Encontrará nuestros datos de contacto en el manual de garantía. Cuando se ponga en contacto con nuestro Servicio Postventa, deberá indicar los códigos que figuran en la placa de características de su producto.

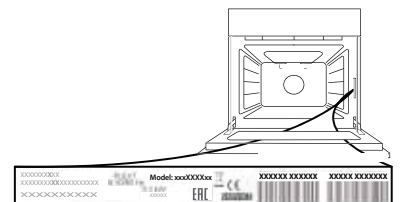

INSTRUÇÕES DE SEGURANÇA

É IMPORTANTE QUE LEIA E RESPEITE ESTAS INSTRUÇÕES

Antes de utilizar o aparelho, leia estas instruções de segurança com atenção. Guarde-as por perto para consulta futura.

As presentes instruções e o próprio aparelho possuem informações importantes relativas à segurança, as quais deverá ler e respeitar sempre. O fabricante não se responsabiliza por quaisquer acontecimentos decorrentes do incumprimento das presentes instruções de segurança, da utilização inadequada do aparelho ou da configuração incorreta dos respetivos controlos.

⚠ As crianças até aos 3 anos devem ser mantidas afastadas do aparelho. As crianças entre os 3 e os 8 anos devem ser mantidas afastadas do aparelho, exceto se estiverem sob supervisão permanente. Este aparelho pode ser utilizado por crianças a partir dos 8 anos e por pessoas com capacidades físicas, sensoriais ou mentais reduzidas ou com falta de experiência e conhecimento, desde que estejam sob supervisão ou tenham recebido instruções quanto à utilização segura deste aparelho e se compreenderem os perigos envolvidos. As crianças não devem brincar com o aparelho. A limpeza e a manutenção a cargo do utilizador não devem ser realizadas por crianças sem supervisão.

⚠ **ADVERTÊNCIA:** O aparelho e os componentes acessíveis ficam quentes durante o funcionamento. Deve ter-se cuidado para evitar tocar nos elementos quentes. Mantenha as crianças com idade inferior a 8 anos afastadas do aparelho a menos que estejam vigiadas em permanência.

⚠ Nunca deixe o aparelho sem vigilância durante a secagem de alimentos. Caso o aparelho seja adequado para a utilização de uma sonda de temperatura, utilize apenas uma sonda recomendada para este aparelho, pois existe o risco de incêndio se assim não for.

⚠ Mantenha quaisquer peças de vestuário ou outros materiais inflamáveis afastados do aparelho até que todos os componentes deste tenham arrefecido completamente, pois existe risco de incêndio. Preste sempre atenção quando cozinhar alimentos ricos em gorduras, óleos ou quando existe a adição de bebidas alcoólicas, pois existe risco de incêndio. Utilize apropriadas luvas para retirar recipientes do forno para retirar painéis e acessórios. No final da cozedura, abra a porta com cuidado, permitindo que o ar quente ou o vapor saia gradualmente antes de aceder à cavidade do forno, caso contrário, existe o risco de queimaduras.. Não obstrua a ventilação de ar quente existente na parte frontal do aparelho, pois existe risco de incêndio.

⚠ Tenha cuidado quando a porta do forno estiver aberta ou para baixo, de forma a evitar bater na porta.

UTILIZAÇÃO PERMITIDA

⚠ **CUIDADO:** o aparelho não deve ser ligado a partir de um temporizador externo, como, por exemplo, um temporizador, nem a partir de um sistema de controlo remoto em separado.

⚠ Este aparelho destina-se a ser usado em ambiente doméstico e em aplicações semelhantes tais como: copas para utilização dos funcionários em lojas, escritórios e outros ambientes de trabalho; quintas de exploração agrícola; clientes em hotéis, motéis, *bed & breakfast* e outros tipos de ambientes residenciais.

⚠ Estão proibidos outros tipos de utilização (por exemplo, aquecimento de divisões da casa).

⚠ Este aparelho não está concebido para o uso profissional. Não utilize o aparelho no exterior.

⚠ Não armazene substâncias explosivas ou inflamáveis (p.ex., gasolina ou latas de aerossol) no interior ou próximas do aparelho, pois existe o risco de incêndio.

INSTALAÇÃO

⚠ O aparelho deve ser transportado e instalado por duas ou mais pessoas, para evitar o risco de lesões. Use luvas de proteção para desembalar e instalar o aparelho, de forma a evitar o risco de cortes.

⚠ A instalação, incluindo a alimentação de água (caso seja necessário) e as ligações elétricas, bem como quaisquer reparações devem ser realizadas por um técnico devidamente qualificado. Não repare nem substitua nenhuma peça do aparelho a não ser que tal seja especificamente indicado no manual de utilização. Mantenha as crianças afastadas do local da instalação. Desembale o aparelho e certifique-se de que este não foi danificado durante o transporte. Se tiverem ocorrido problemas, contacte o revendedor ou o Serviço Pós-Venda mais próximo. Uma vez instalado o aparelho, os elementos da embalagem (plástico, peças de esferovite, etc.) devem ser armazenados longe do alcance das crianças, pois existe o risco de asfixia. Deve desligar o aparelho da corrente elétrica antes de efetuar qualquer operação de instalação, para evitar o risco de choques elétricos. Durante a instalação, certifique-se de que o aparelho não danifica o cabo de alimentação, pois existe o risco de incêndio ou de choques elétricos. Ligue o aparelho apenas após concluir a instalação do mesmo.

⚠ Execute todos os trabalhos de corte no móvel antes de instalar o forno e remova todas as lascas de madeira e serradura.

Não obstrua o espaço mínimo existente entre a bancada e o rebordo superior do aparelho, para evitar o risco de queimaduras.

Não retire a base de espuma de poliestireno do aparelho até à altura da instalação.

⚠ Após a instalação, a base do aparelho não deverá ficar acessível, pois existe o risco de queimaduras.

⚠ Não instale o aparelho atrás de uma porta decorativa, para evitar o risco de incêndio.

AVISOS RELATIVOS À ELETRICIDADE

⚠ A chapa de características encontra-se na extremidade frontal do forno visível com a porta aberta.

⚠ Deve ser possível desligar o aparelho da fonte de alimentação, desligando-o na ficha, caso esta esteja acessível, ou através de um interruptor multipolar instalado na tomada de acordo com a regulamentação aplicável a ligações elétricas; além disso, o aparelho deve dispor de ligação à terra, de acordo com as normas de segurança elétrica nacionais.

⚠ Não utilize extensões, tomadas múltiplas ou adaptadores. Após a instalação do aparelho, os componentes elétricos devem estar inacessíveis ao utilizador. Não utilize o aparelho com os pés descalços ou molhados. Não ligue este aparelho se o cabo ou a ficha elétrica apresentar danos, se não estiver a funcionar corretamente, se estiver danificado ou se tiver caído.

⚠ Se o cabo de alimentação estiver danificado deverá ser substituído por um idêntico do mesmo fabricante ou por um técnico de assistência ou pessoas similarmente qualificadas de modo a evitar a ocorrência de situações perigosas, pois existe o risco de choques elétricos.

⚠ Em caso de substituição de alimentação, contacte um Centro de Assistência autorizado.

LIMPEZA E MANUTENÇÃO

⚠ **ADVERTÊNCIA:** Assegure-se de que o aparelho está desligado da fonte de alimentação antes de realizar quaisquer operações de manutenção; nunca use uma máquina de limpeza a vapor para limpar o aparelho - risco de choques elétricos.

⚠ Não utilize produtos de limpeza abrasivos, nem raspadores metálicos afiados para limpar a porta de vidro do aparelho, pois estes podem riscar a sua superfície, o que pode fazer com que o vidro quebre.

⚠ Certifique-se de que o aparelho está frio antes de o limpar ou fazer a manutenção, pois existe risco de queimaduras.

⚠ **ADVERTÊNCIA:** Desligue o aparelho antes de substituir a lâmpada, para evitar o risco de choques elétricos.

ELIMINAÇÃO DA EMBALAGEM

O material da embalagem é 100% reciclável, conforme indicado pelo símbolo de reciclagem ♻.

As várias partes da embalagem devem ser eliminadas de forma responsável e em total conformidade com as normas estabelecidas pelas autoridades locais.

ELIMINAÇÃO DE ELETRODOMÉSTICOS

Este aparelho é fabricado com materiais recicláveis ou reutilizáveis. Elimine-o em conformidade com as normas de eliminação de resíduos locais. Para obter mais informações sobre o tratamento, recuperação e reciclagem de eletrodomésticos, contacte as autoridades locais, o serviço de recolha de resíduos domésticos ou a loja onde adquiriu o aparelho. Este aparelho está classificado em conformidade com a Diretiva Europeia 2012/19 / UE relativa aos Resíduos de Equipamentos Elétricos e Eletrónicos (REEE) e com os regulamentos referentes à gestão de resíduos de equipamentos elétricos e eletrónicos de 2013 (conforme alteração).

Ao assegurar a eliminação correta deste produto, estamos a proteger o ambiente e a saúde humana contra riscos negativos.

O símbolo  no produto, ou nos documentos que acompanham o produto, indica que este aparelho não deve ser tratado como resíduo doméstico e deve ser transportado para um centro de recolha adequado para proceder à reciclagem do equipamento elétrico e eletrónico.

SUGESTÕES PARA POUPAR ENERGIA

Aqueça previamente o forno apenas se indicado na tabela de cozedura ou na receita. Utilize tabuleiros de assar lacados de preto ou esmaltadas, pois estas absorvem melhor o calor. Os alimentos que necessitem de uma cozedura mais prolongada continuarão a ser cozinhados mesmo com o forno desligado.

DECLARAÇÃO DE DESIGN ECOLÓGICO

Este aparelho está em conformidade com: Os requisitos de conceção ecológica do regulamento europeu n.º 66/2014; O regulamento de rotulagem energética n.º 65/2014; Os requisitos de conceção ecológica dos produtos relacionados com o consumo de energia e o regulamento sobre as informações energéticas (alteração) (saída UE) de 2019 em conformidade com a norma europeia EN 60350-1.

GUIA DE CONSULTA DIÁRIA



OBRIGADO POR ADQUIRIR UM PRODUTO WHIRLPOOL

Para receber mais informações e assistência, registe o seu produto em www.whirlpool.eu/register



Pode transferir as Instruções de Segurança e o Guia de Utilização e Manutenção, visitando o nosso website docs.whirlpool.eu e seguindo as instruções no verso do presente guia.



Antes de utilizar o aparelho, leia atentamente o guia de Saúde e Segurança.

DESCRIÇÃO DO PRODUTO

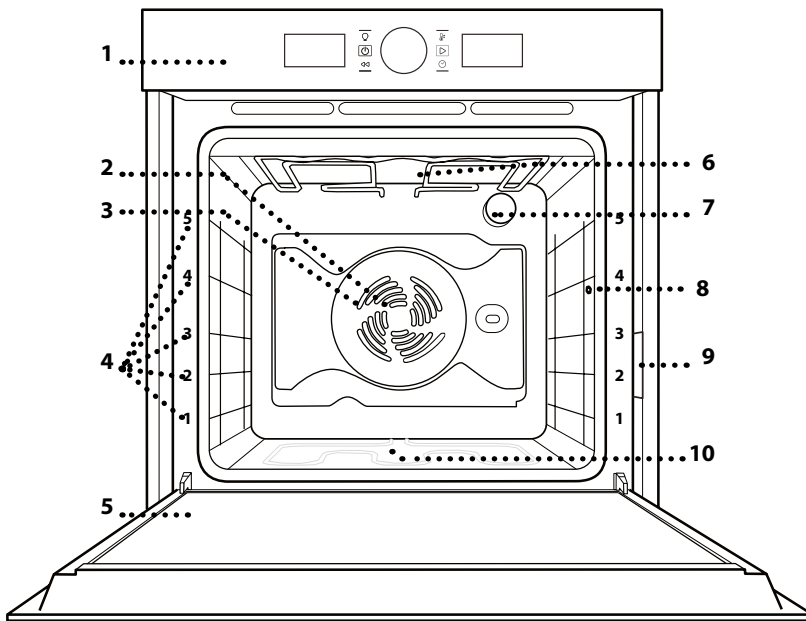

1. Painel de controlo
2. Ventoinha
3. Resistência circular (não visível)
4. Guias de nível (o nível está indicado na parte frontal do forno)
5. Porta
6. Resistência superior/grelhador
7. Lâmpada
8. Ponto de inserção do termómetro de carne (se existente)
9. Placa de identificação (não remover)
10. Resistência inferior (não visível)

PAINEL DE CONTROLO

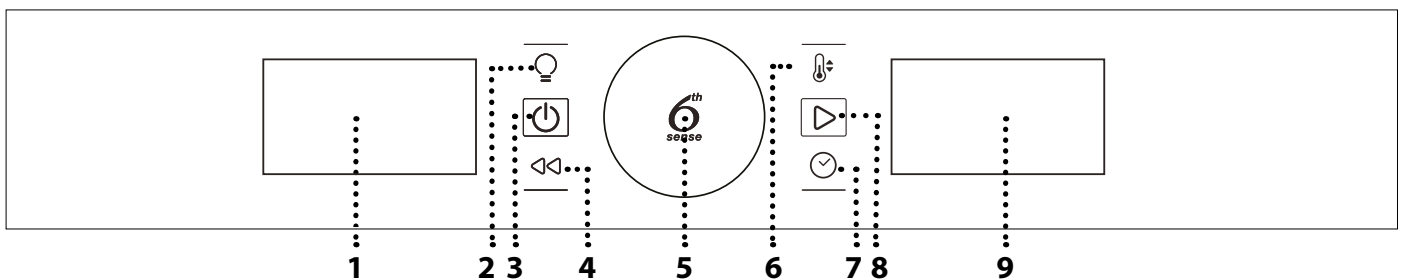

1. VISOR ESQUERDO

2. LUZ

Para acender/desligar a luz.

3. LIGAR/DESLIGAR

Para ligar e desligar o forno e parar uma função ativa a qualquer momento.

4. RETROCEDER

Para regressar ao menu anterior ao configurar definições.

5. BOTÃO ROTATIVO/BOTÃO 6TH SENSE

Rode-o para navegar pelas funções e ajustar todos os parâmetros de cozedura. Prima  para selecionar, definir, aceder ou confirmar funções ou parâmetros e, eventualmente, para iniciar o programa de cozedura.

6. TEMPERATURA

Para definir a temperatura.

7. TEMPO

Para definir ou alterar a hora e ajustar o tempo de cozedura.

8. INICIAR

Para iniciar funções e confirmar definições.

9. VISOR DIREITO

ACESSÓRIOS

GRELHA

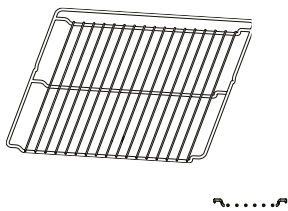

TABULEIRO COLETOR

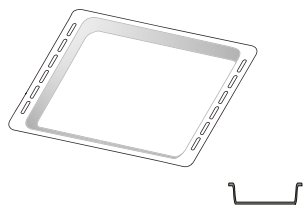

TABULEIRO PARA ASSAR

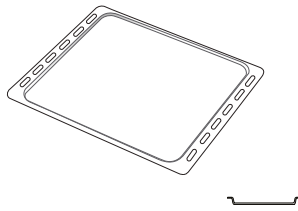

CALHAS DESLIZANTES (APENAS EM ALGUNS MODELOS)

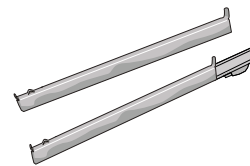

TERMÓMETRO DE CARNE (APENAS EM ALGUNS MODELOS)

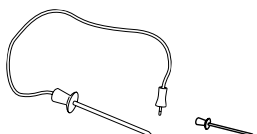

O número de acessórios pode variar de acordo com o modelo adquirido. Pode adquirir separadamente outros acessórios no Serviço Pós-venda.

INTRODUZIR GRELHAS E OUTROS ACESSÓRIOS

Introduza a grelha na horizontal, fazendo-a deslizar pelas guias, e assegure-se de que a extremidade elevada está virada para cima.

Outros acessórios, como o tabuleiro coletor e o tabuleiro para pastelaria são introduzidos horizontalmente, da mesma forma que a grelha.

RETIRAR E REPOR AS GUIAS DE NÍVEL

Observe as imagens, para retirar os suportes laterais e (se existirem) as porcas da cavidade que fixam as mesmas.

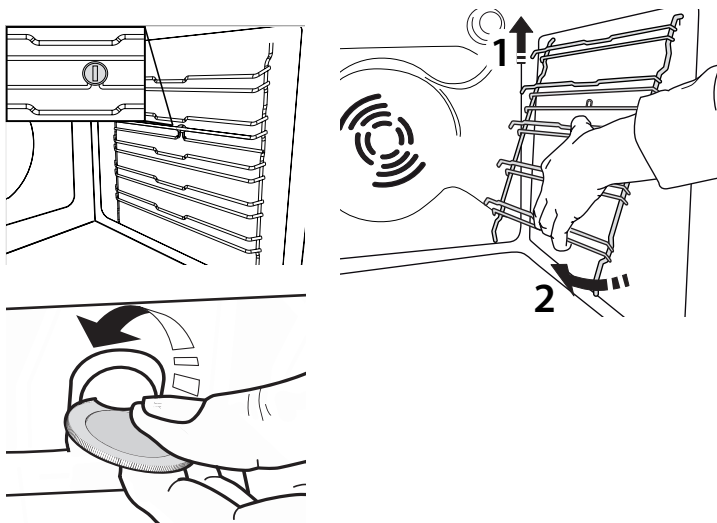

COMO INSTALAR AS CALHAS DESLIZANTES (CASO EXISTAM)

Retire as guias de nível do forno e remova o plástico de proteção das correias.

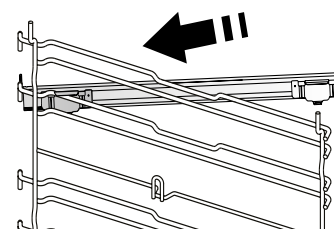

Fixe o encaixe superior da correia à guia de nível e faça-a deslizar até parar. Baixe o outro encaixe para o posicionar.

Para fixar a guia, pressione a parte inferior do dispositivo de fixação firmemente contra a guia de nível. Assegure-se de que as correias se movem livremente. Repita estes procedimentos para a outra guia de nível, no mesmo nível.

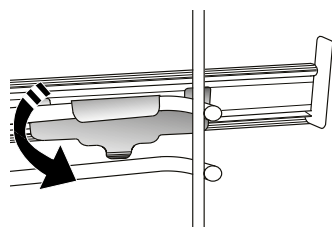

Lembre-se: As correias podem ser instaladas em qualquer nível.

Para repor as guias de nível, comece por inseri-las no suporte superior. Mantendo-as subidas, faça-as deslizar para o interior do compartimento de cozedura e, em seguida, posicione-as no suporte inferior.

FUNÇÕES

CONVENCIONAL

Para cozinhar qualquer tipo de alimento utilizando apenas um nível.

GRELHADOR

Para grelhar bifés, espetadas, salsichas, gratinar legumes ou tostar pão. Ao grelhar carne, recomendamos a utilização de um tabuleiro coletor, para recolher os sucos da cozedura: posicione o tabuleiro em qualquer um dos níveis que se encontram abaixo da grelha e adicione 500 ml de água potável.

AR FORÇADO

Para cozinhar diferentes alimentos, que exijam a mesma temperatura de cozedura, em diferentes níveis (três, no máximo) e em simultâneo. Esta função permite cozinhar alimentos diferentes sem transmitir odores de uns alimentos para os outros.

COZEDURA CONVECÇÃO

Para cozinhar carne, fazer bolos com recheios ou assar legumes recheados num único nível. Esta função utiliza uma circulação suave e intermitente do ar para evitar a desidratação excessiva dos alimentos.



FUNÇÕES 6TH SENSE

GRATINADOS

Esta função seleciona automaticamente a melhor temperatura e método de cozedura para pratos de massa.

CARNE

Esta função seleciona automaticamente a melhor temperatura e método de cozedura para a carne. Esta função ativa de forma intermitente a ventoinha, a baixa velocidade, para evitar que os alimentos sequem em demasia.

MAXI COZEDURA

A função seleciona automaticamente a melhor temperatura e o melhor modo de cozedura para confeccionar peças de carne grandes (acima de 2,5 kg). Recomendamos que vire a carne durante a cozedura para que fique dourada de forma homogénea de ambos os lados. É conveniente regá-la com molho esporadicamente para que não seque demasiado.

PÃO

Esta função seleciona automaticamente a melhor temperatura e método de cozedura para todos os tipos de pão.

PIZZA

Esta função seleciona automaticamente a melhor temperatura e método de cozedura para todos os tipos de pizza.

BOLOS DOCES

Esta função seleciona automaticamente a melhor temperatura e método de cozedura para todos os tipos de bolo.



FUNÇÕES ESPECIAIS

PRÉ-AQUEC. RÁPIDO

Para efetuar o pré-aquecimento rápido do forno. Concluído o pré-aquecimento, o forno irá selecionar a função "Convencional" automaticamente. Aguarde que o pré-aquecimento termine, antes de colocar alimentos no forno.

TURBO GRILL

Para assar peças de carne grandes (pernil, rosbife, frango). Recomendamos a utilização de um tabuleiro coletor, para recolher os sucos da cozedura: Posicione o tabuleiro em qualquer um dos níveis que se encontram abaixo da grelha e adicione 500 ml de água potável. O espeto (se disponível) pode ser utilizado com esta função.

AR FORÇADO ECO *

Para cozinhar peças de carne recheadas e carne fatiada num único nível. Evita-se que os alimentos sequem excessivamente, através de uma circulação de ar suave e intermitente. Quando esta função está a ser utilizada, a luz mantém-se apagada ao longo da cozedura. Para usar o ciclo ECO e, assim, otimizar o consumo de energia, a porta do forno não deve ser aberta até que os alimentos estejam completamente cozinhados.

MANUTENÇÃO DO CALOR

Para manter os alimentos quentes e estaladiços depois de cozinhados.

LEVEDURA

Para obter a fermentação ideal de massas doces ou salgadas. Para manter a qualidade da levedação, não ativar a função se o forno ainda estiver quente após um ciclo de cozedura.

SMART CLEAN

(APENAS EM ALGUNS MODELOS)
A ação do vapor libertado durante este ciclo de limpeza a baixa temperatura especial permite a fácil remoção de resíduos de sujidade de comida. Verta 200 ml de água na parte inferior da cavidade e ative a função quando o forno estiver frio.

* Função utilizada como referência para a declaração de eficiência energética, de acordo com o Regulamento (UE) n.º 65/2014

PRIMEIRA UTILIZAÇÃO DO APARELHO

1. ACERTAR A HORA

Ao ligar o forno pela primeira vez, terá de definir a hora.



Os dois dígitos da hora começam a piscar: Rode o botão para definir a hora e prima para confirmar.



Os dois dígitos dos minutos começam a piscar. Rode o botão para definir os minutos e prima para confirmar.

Lembre-se: Para alterar a hora posteriormente, prima e mantenha premido durante, pelo menos, um segundo com o forno desligado e repita os passos acima.

Poderá ter de acertar novamente a hora após um longo corte de energia.

2. DEFINIÇÕES

Se necessário, pode alterar a unidade de medição, a temperatura (°C) e a corrente nominal (16 A) predefinidas.

Com o forno desligado, prima e mantenha premido durante, pelo menos, 5 segundos.



Rode o botão seletor para selecionar a unidade de medição e, em seguida, prima para confirmar.



Rode o botão seletor para selecionar a corrente nominal e, em seguida, prima para confirmar.

Lembre-se: O forno está programado para consumir um nível de energia elétrica compatível com uma rede doméstica de potência superior a 3 kW (16 A): Se a potência que utiliza em sua casa for inferior, terá de reduzir este valor (13 A).

3. AQUECER O FORNO

Um forno novo pode libertar odores residuais, resultantes do processo de fabrico: isto é perfeitamente normal.

Assim, antes de começar a cozinhar alimentos, recomendamos que aqueça o forno, vazio, para eliminar eventuais odores.

Remova do forno qualquer elemento de proteção em cartão ou película transparente e retire quaisquer acessórios do respetivo interior.

Aqueça o forno a 200 °C durante uma hora, aproximadamente, de preferência utilizando uma função com circulação de ar (por exemplo "Ar forçado" ou "Cozedura convecção").

Siga as instruções para programar corretamente a função.

Lembre-se: é aconselhável arejar a cozinha após a primeira utilização do aparelho.

UTILIZAÇÃO DIÁRIA

1. SELECIONAR UMA FUNÇÃO

Quando o forno está desligado, só aparece a hora no visor. Prima e mantenha premido para ligar o forno. Rode o botão para visualizar as funções principais disponíveis no visor esquerdo. Selecione uma e prima .

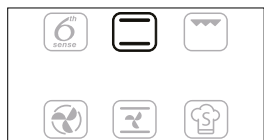

Para selecionar uma subfunção (se disponível), selecione a função principal e, em seguida, prima para confirmar e aceder ao menu de funções.

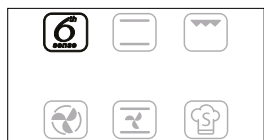

Rode o botão para visualizar as subfunções disponíveis no visor esquerdo. Selecione uma e prima para confirmar.

2. DEFINIR UMA FUNÇÃO

Após selecionar uma função, é possível alterar as suas definições.

O visor irá apresentar as definições que podem ser alteradas em sequência.

TEMPERATURA/NÍVEL DO GRILL



Se o ícone °C/°F estiver a piscar no visor, rode o botão para alterar o valor, em seguida prima para confirmar e continuar a alterar as definições seguintes (se possível).

Pode também definir o nível do grelhador (3 = alto, 2 = médio, 1 = baixo) em simultâneo.



Lembre-se: assim que a função tiver iniciado, pode alterar a temperatura ou o nível do grelhador premindo ou rodando diretamente o botão.

DURAÇÃO



Quando o ícone pisca no visor, utilize o botão de ajuste para definir o tempo de cozedura pretendido e, em seguida, prima para confirmar.

Não precisa de definir o tempo de cozedura, caso pretenda gerir a cozedura manualmente: Prima para confirmar e iniciar a função.

Neste caso, não poderá definir o tempo de fim da cozedura, programando um início atrasado.

Lembre-se: Pode ajustar o tempo de cozedura definido durante a cozedura, premindo : Rode o botão para alterar a hora e prima para confirmar.

DEFINIR O TEMPO DE FIM DA COZEDURA/ INÍCIO ATRASADO

Em muitas funções, uma vez definido um tempo de cozedura, pode atrasar o início da função programando o seu tempo de fim.

Quando for possível alterar o tempo de fim, aparece no visor a hora a que se espera a conclusão da função com o ícone a piscar.



Se necessário, rode o botão para definir a hora de fim de cozedura e, em seguida, prima para confirmar e iniciar a função.

Coloque os alimentos no forno e feche a porta: A função inicia-se automaticamente após o período de tempo calculado para concluir a cozedura à hora programada.



Nota: Programar um início diferido da cozedura irá desativar a fase de pré-aquecimento do forno. O forno atinge a temperatura pretendida gradualmente, o que significa que os tempos de cozedura poderão ser ligeiramente mais longos do que os tempos indicados na tabela de cozedura.

Durante o tempo de espera, pode utilizar o botão para alterar o tempo de fim programado.

Prima ou para alterar as definições da temperatura e do tempo de cozedura. Prima para confirmar quando concluir.

Nota: A funcionalidade de atraso de arranque não está disponível para as funções Grill e Turbo Grill.

3. ATIVAR UMA FUNÇÃO

Após aplicar todas as definições pretendidas, prima para ativar a função.

Pode premir e manter premido , a qualquer momento, para interromper a função que estiver ativa nessa altura.

4. PRÉ-AQUECIMENTO

Algumas funções dispõem de uma fase de pré-aquecimento do forno: Uma vez iniciada a função, o visor indica que a fase de pré-aquecimento foi ativada.



Quando esta fase estiver concluída, será emitido um sinal sonoro e o visor indicará que o forno atingiu a temperatura programada.



Neste momento, abra a porta, coloque os alimentos no forno, feche a porta e inicie a cozedura premindo .

Lembre-se: Colocar os alimentos no forno antes de o pré-aquecimento estar concluído pode ter um efeito adverso no resultado final da cozedura.

Abrir a porta durante a fase de pré-aquecimento fará com que esta seja interrompida.

O tempo de cozedura não inclui uma fase de pré-aquecimento.

Pode sempre alterar a temperatura que pretende atingir, utilizando o botão.

5. FIM DA COZEDURA

Será emitido um sinal sonoro e o visor indicará que a cozedura está concluída.



Para aumentar o tempo de cozedura sem alterar as definições, rode o botão para definir um novo tempo de cozedura e prima .

. FUNÇÕES 6th SENSE

RECUPERAÇÃO DE TEMPERATURA

Se a temperatura no interior do forno baixar durante um ciclo de cozedura por a porta estar aberta, será automaticamente ativada uma função especial para recuperar a temperatura original. Durante a recuperação da temperatura, o visor irá exibir uma animação tipo "cobra" até ter sido alcançada a temperatura definida.

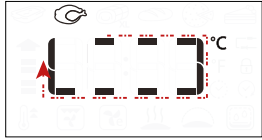

Enquanto um ciclo de cozedura programado está em curso, o tempo de cozedura aumenta de acordo com o tempo de abertura da porta, de forma a garantir os melhores resultados.

. FUNÇÕES ESPECIAIS

SMART CLEAN

Para ativar a função "Smart Clean", com o forno frio, distribua 200 ml de água pelo fundo da cavidade do forno e, em seguida, feche a porta do forno.

Aceda às funções especiais e rode o botão seletor para selecionar a partir do menu. Em seguida prima para confirmar.

Prima para iniciar de imediato o ciclo de limpeza ou prima para selecionar o tempo de fim/início programado.

No fim do ciclo, deixe o forno arrefecer e retire qualquer água residual que exista no forno e inicie a limpeza com uma esponja humedecida em água quente (a limpeza poderá não resultar bem se deixar passar mais de 15 minutos).

Lembre-se: Não é possível definir a duração e a temperatura do ciclo de limpeza

. UTILIZAR O TERMÓMETRO DE CARNE (SE EXISTENTE)

O termómetro de carne fornecido permite medir a temperatura interna exata dos alimentos durante a cozedura.

O termómetro de carne só é permitido em algumas funções de cozedura (Convencional, Ar forçado, Cozedura por convecção, Turbo Grill, 6th Sense Carne e 6th Sense Maxicooking).

É muito importante posicionar o termómetro com precisão, para obter resultados de cozedura perfeitos. Insira completamente o termómetro na parte com mais carne, evitando os ossos e as partes com mais gordura.

Quando cozinhar aves, o termómetro deve ser inserido de lado, no meio do peito, tendo o cuidado de assegurar que a ponta não fica localizada sobre uma parte oca. No caso de carne com

espessura muito irregular, verifique se esta está devidamente cozinhada antes de a retirar do forno. Ligue a extremidade do termómetro ao orifício situado na parede direita da cavidade do forno.

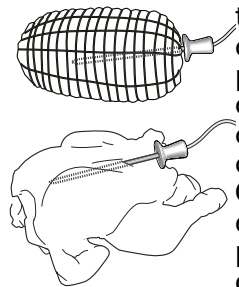

Quando o termómetro de carne é ligado à cavidade do forno, é emitido um sinal sonoro e o visor apresenta o ícone e a temperatura pretendida.

Se o termómetro de carne for ligado durante a seleção de uma função, o visor muda para a temperatura pretendida predefinida para o termómetro de carne.



Prima para iniciar as definições. Rode o botão para definir a temperatura pretendida para o termómetro de carne. Prima para confirmar. Rode o botão para definir a temperatura da cavidade do forno.



Prima ou para confirmar e iniciar o ciclo de cozedura.

Durante o ciclo de cozedura, o visor indica a temperatura pretendida para o termómetro de carne. Quando a carne atinge a temperatura pretendida definida, o ciclo de cozedura para e o visor indica "End" (fim).

Para reiniciar o ciclo de cozedura a partir de "End" (fim), rodando o botão é possível ajustar a temperatura pretendida para o termómetro de carne como indicado acima. Prima ou para confirmar e reiniciar o ciclo de cozedura.

Lembre-se: durante o ciclo de cozedura com o termómetro de carne, é possível rodar o botão para alterar a temperatura pretendida para o termómetro de carne. Prima para regular a temperatura da cavidade do forno.

O termómetro de carne pode ser inserido a qualquer momento, incluindo durante um ciclo de cozedura.

Neste caso, é necessário redefinir os parâmetros da função de cozedura.

Se o termómetro de carne for incompatível com uma função, o forno desativa o ciclo de cozedura e emite um sinal sonoro de alerta. Neste caso, desligue o termómetro de carne ou prima para definir outra função. O início diferido e a fase de pré-aquecimento não são compatíveis com o termómetro de carne.

. PROTEÇÃO

Para bloquear o teclado, prima e mantenha premido durante, pelo menos, 5 segundos.



Para desbloquear, repita o procedimento.

Lembre-se: a proteção pode também ser ativada durante a cozedura.

Por motivos de segurança, o forno pode ser desligado a qualquer altura premindo .

CONSELHOS ÚTEIS

COMO EFETUAR A LEITURA DA TABELA DE COZEDURA

A tabela indica a função, os acessórios e o nível mais adequados para utilizar na confeção dos diferentes tipos de alimentos. Os tempos de cozedura começam a partir do momento em que o alimento é colocado no forno, excluindo o pré-aquecimento (sempre que necessário). As temperaturas e os tempos de cozedura são aproximados e dependem da quantidade de alimento e do tipo de acessório utilizado. Comece por utilizar as definições mais baixas recomendadas e, se o alimento não ficar bem cozinhado, mude para definições mais elevadas. Utilize os acessórios fornecidos e, de preferência, formas para bolos e tabuleiros para assar metálicos e de cor escura. Também poderá utilizar recipientes e acessórios em cerâmica ou pirex, mas tenha em conta que os tempos de cozedura serão ligeiramente superiores.

COZINHAR DIFERENTES ALIMENTOS EM SIMULTÂNEO

A função "Ar Forçado" permite cozinhar alimentos diferentes em simultâneo (por exemplo: peixe e legumes), em níveis diferentes. Retire os alimentos que necessitam de um tempo de cozedura mais curto e deixe no forno os alimentos que necessitam de um tempo de cozedura mais longo.

CARNE

Utilize qualquer tipo de tabuleiro para fornos ou pirex adequado ao tamanho do pedaço de carne a cozinhar. No caso de assados coloque, de preferência, caldo no fundo da travessa e regue a carne durante a cozedura para obter um melhor sabor. Tenha em atenção que será gerado vapor durante esta operação. Quando o assado estiver pronto, deixe-o repousar no forno durante 10-15 minutos adicionais ou envolva-o em folha de alumínio.

Sempre que quiser grelhar carne, selecione pedaços de carne com uma espessura uniforme para alcançar resultados de cozedura uniformes. Os pedaços de carne muito grossos necessitam de tempos de cozedura mais prolongados. Para evitar que a carne fique demasiado tostada no exterior, baixe a posição da grelha, afastando o alimento um pouco mais do grelhador. Vire a carne quando atingir dois terços do tempo de cozedura. Abra a porta com cuidado, já que pode sair vapor.

Para recolher os sucos da cozedura, recomendamos que coloque uma tabuleiro coletor com meio litro de água potável diretamente por baixo da grelha onde estão os alimentos. Encha totalmente sempre que necessário.

SOBREMESAS

Cozinhe sobremesas delicadas com a função convencional num único nível.

Utilize formas para assar metálicas de cor escura e coloque-as sempre na grelha fornecida. Para cozinhar em diversos níveis, selecione a função de ar forçado e disponha as formas para bolos nas grelhas, em posições alternadas, para permitir uma boa circulação de ar quente.

Para verificar se um bolo levedado está cozido, insira um palito de madeira no centro do mesmo. Se o palito sair limpo, significará que o bolo está pronto.

Se utilizar uma forma para assar antiaderente, não unte as extremidades da mesma com manteiga pois poderá impedir o crescimento uniforme do bolo nas extremidades.

Se o bolo ou o pão "crescer" durante a cozedura, utilize uma temperatura mais baixa da próxima vez e experimente reduzir a quantidade de líquidos adicionados ou mexer a mistura mais suavemente. No caso de sobremesas com recheios húmidos ou coberturas (tais como cheesecake ou tartes de frutas) utilize a função "Cozedura convecção". Se a base do bolo ou do pão ficar mal cozida, baixe a prateleira e polvilhe a base do bolo com miolo de pão ou miolo de biscoito antes de adicionar o recheio.

















































































PIZZA

Unte ligeiramente o tabuleiro para se certificar de que a pizza vai ficar com uma base estaladiça. Espalhe o queijo mozzarella sobre a pizza quando atingir dois terços do tempo de cozedura.

LEVEDURA

É sempre melhor cobrir a massa com um pano húmido antes de a colocar no forno. O tempo de levedação com esta função é reduzido em cerca de um terço em comparação com uma levedação à temperatura ambiente (20-25 °C). O tempo de levedação para uma quantidade de 1 kg de massa para pizza é de cerca de uma hora.

TABELA DE COZEDURA

RECEITA	FUNÇÃO	PRÉ-AQUECIM.	TEMPERATURA (°C)	TEMPO COZEDURA (min)	NÍVEL E ACESSÓRIOS
Bolos levedados/Pães de ló		-	170	30 - 50	2 
		Sim	160	30 - 50	2 
		Sim	160	30 - 50	4 1  
Bolos recheados (cheesecake, strudel, tarte de maçã)		-	160 - 200	30 - 85	3 
		Sim	160 - 200	35 - 90	4 1  
Bolachas/Bolos pequenos		-	160 - 170	20 - 40	3 
		Sim	150 - 160	20 - 40	3 
		Sim	150 - 160	20 - 40	4 1  
Massa choux		-	180 - 200	30 - 40	3 
		Sim	180 - 190	35 - 45	4 1  
		Sim	180 - 190	35 - 45*	5 3 1   
Merengues		Sim	90	110 - 150	3 
		Sim	90	130 - 150	4 1  
		Sim	90	140 - 160*	5 3 1   
Pizza (massa fina, massa grossa, focaccia)		-	220 - 250	20 - 40	2 
		Sim	220 - 240	20 - 40	4 1  
		Sim	220 - 240	25 - 50*	5 3 1   
Pão de forma 0,5 kg		-	180 - 220	50 - 70	2 
Pão pequeno		-	180 - 220	30 - 50	3 
Pão		Sim	180 - 220	30 - 60	4 1  
Pizza congelada		-	250	10 - 20	2 
		Sim	250	10 - 20	4 1  
Tartes salgadas (tarte de legumes, quiche)		Sim	180 - 190	45 - 60	2 
		Sim	180 - 190	45 - 60	4 1  
		Sim	180 - 190	45 - 70*	5 3 1   
Vol-au-vent/Salgadinhos de massa folhada		Sim	190 - 200	20 - 30	3 
		Sim	180 - 190	20 - 40	4 1  
		Sim	180 - 190	20 - 40*	5 3 1   
Lasanha/desenformados		-	190 - 200	40 - 65	3 
Cozer massa/canelones		-	190 - 200	25 - 45	3 

RECEITA	FUNÇÃO	PRÉ-AQUECIM.	TEMPERATURA (°C)	TEMPO COZEDURA (min)	NÍVEL E ACESSÓRIOS
Borrego/Vitela/Vaca/Porco 1 kg		-	190 - 200	60 - 90	3
Carne de porco assada com courato 2 kg		-	170	110 - 150	2
Frango/coelho/pato 1 kg		-	200 - 230	50 - 80 **	3
Peru/ganso 3 kg		-	190 - 200	90 - 150	2
Peixe no forno/em papelote (filetes, inteiro)		Sim	180 - 200	40 - 60	3
Legumes recheados (tomates, curgetes, beringelas)		Sim	180 - 200	50 - 60	2
Pão tostado		-	3 (alto)	3 - 6	5
Filetes/postas de peixe		-	2 (médio)	20 - 30***	4 3
Salsichas/Espetadas/Costeletas/Hambúrgues		-	2 - 3 (médio-alto)	15 - 30***	5 4
Frango assado 1-1,3 kg		-	2 (médio)	55 - 70**	2 1
Rosbife mal passado 1 kg		-	2 (médio)	35 - 50**	3
Perna de borrego/pernis		-	2 (médio)	60 - 90**	3
Batatas assadas		-	2 (médio)	35 - 55**	3
Gratinado de legumes		-	3 (alto)	10 - 25	3
Refeição completa: Tarte de frutas (nível 5) / lasanha (nível 3) / carne (nível 1)		Sim	190	40 - 120*	5 3 1
Lasanha e Carne		Sim	200	50 - 120*	4 1
Carne e Batatas		Sim	200	45 - 120*	4 1
Peixe e legumes		Sim	180	30 - 50	4 1
Peças de carne recheadas		-	200	80 - 120*	3
Peças de carne (coelho, frango, borrego)		-	200	50 - 120*	3

* Período de tempo estimado: Os alimentos podem ser retirados do forno quando o desejar, dependendo da preferência de cada um.

** Vire o alimento quando atingir dois terços do tempo de cozedura (se necessário).

*** Vire o alimento a meio da cozedura.

Lembre-se: A função 6th Sense "Pastelaria" utiliza apenas as resistências superior e inferior, sem a circulação de ar forçado. Não requer pré-aquecimento.

FUNÇÕES						
	Convencional	Grill	Turbo Grill	Ar forçado	Cozedura convecção	Ar Forçado Eco
FUNÇÕES AUTOMÁTICAS						
	Gratinados	Carne	Maxi Cozedura	Pão	Pizza	Bolos doces
ACESSÓRIOS						
	Grelha	Tabuleiro de assar ou forma de bolos na grelha metálica	Tabuleiro coletor/tabuleiro para pastelaria ou assadeira na grelha	Tabuleiro coletor / tabuleiro para assar	Tabuleiro coletor com 500 ml de água	

LIMPEZA E MANUTENÇÃO

Assegure-se de que o forno arrefece antes de executar qualquer operação de manutenção ou limpeza.

Não utilize aparelhos de limpeza a vapor.

Não utilize palha de aço, esfregões abrasivos ou produtos de limpeza abrasivos/corrosivos, uma vez que estes podem danificar as superfícies do aparelho.

Use luvas de proteção.

O forno tem de ser desligado da rede elétrica antes da realização de qualquer tipo de trabalho de manutenção.

SUPERFÍCIES EXTERIORES

- Limpe as superfícies com um pano de microfibra húmido. Se estiverem muito sujas, acrescente alguns pingos de detergente com PH neutro. Termine a limpeza com um pano seco.
- Não utilize detergentes corrosivos ou abrasivos. Se algum destes produtos entrar, inadvertidamente, em contacto com as superfícies do aparelho, limpe imediatamente com um pano de microfibra úmido.

SUPERFÍCIES INTERIORES

- Depois de cada utilização, deixe o forno arrefecer e, depois, limpe-o, preferencialmente enquanto ainda está morno, para remover quaisquer depósitos ou manchas causadas por restos de alimentos. Para secar qualquer condensação que se tenha formado em resultado da cozedura de alimentos com um elevado teor de água, deixe o forno arrefecer completamente e, depois, limpe-o com um pano ou uma esponja.

- Limpe o vidro da porta com um detergente líquido adequado.
- Ative a função "Smart Clean" para obter os melhores resultados de limpeza das superfícies internas do forno (se existente).
- A porta do forno pode ser removida para facilitar a limpeza.
- A resistência superior da grelha pode ser baixada para limpar o painel superior do forno.

ACESSÓRIOS

Após a utilização, coloque os acessórios numa solução líquida de limpeza, pegando nos mesmos com luvas de forno, caso ainda estejam quentes. Os restos de alimentos podem ser retirados com uma esponja ou escova de limpeza.

LIMPEZA DOS PAINÉIS CATALÍTICOS

(APENAS EM ALGUNS MODELOS)

Este forno está equipado com painéis catalíticos especiais, que facilitam a limpeza do compartimento de cozedura graças à sua camada de limpeza automática especial, que é altamente porosa e capaz de absorver gordura e sujidade.

Estes painéis estão instalados nas guias de nível: Ao reposicionar e, depois, reinstalar as guias de nível, certifique-se de que os ganchos na parte superior estão inseridos nos orifícios apropriados dos painéis.

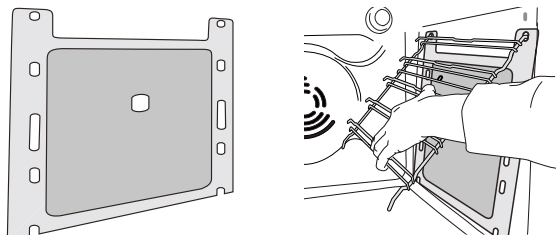

Para fazer o melhor uso possível das propriedades de limpeza automática dos painéis catalíticos, recomendamos que aqueça o forno a 200 °C durante cerca de uma hora, utilizando a função "Cozedura Convecção". O forno deve estar vazio durante o aquecimento. Deixe o aparelho arrefecer antes de remover quaisquer resíduos de alimentos através de uma esponja não abrasiva.

Lembre-se: A utilização de produtos de limpeza corrosivos ou abrasivos, escovas ásperas, esfregões para panelas ou sprays para fornos pode danificar a superfície catalítica e comprometer as suas propriedades de limpeza automática.

Se necessitar de painéis de substituição, contacte o nosso Serviço Pós-Venda.

SUBSTITUIR A LÂMPADA

1. Desligue o forno da corrente elétrica.
2. Desaperte a cobertura da luz, substitua a lâmpada e aperte novamente a cobertura da luz.
3. Ligue o forno novamente à corrente elétrica.

Lembre-se: Utilize apenas lâmpadas de halogéneo de 20-40 W/230 ~ V tipo G9, T300 °C. A lâmpada utilizada no produto foi especificamente concebida para eletrodomésticos e não é adequada para a iluminação geral de divisões da casa (Regulamento CE 244/2009). As lâmpadas estão disponíveis no nosso Serviço Pós-Venda.

- Se utilizar lâmpadas de halogéneo, não as manuseie com as mãos nuas, uma vez que as suas impressões digitais podem provocar danos. Não utilize o forno até que a cobertura da luz tenha sido reposta. Este produto contém uma fonte de luz da classe de eficiência energética G.

BAIXE A RESISTÊNCIA SUPERIOR (APENAS EM ALGUNS MODELOS)

1. Remova as guias de nível laterais.

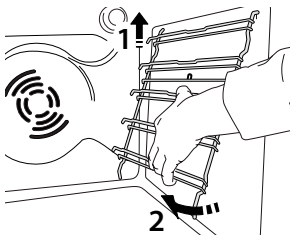

2. Puxe a resistência ligeiramente para fora e baixe-a.

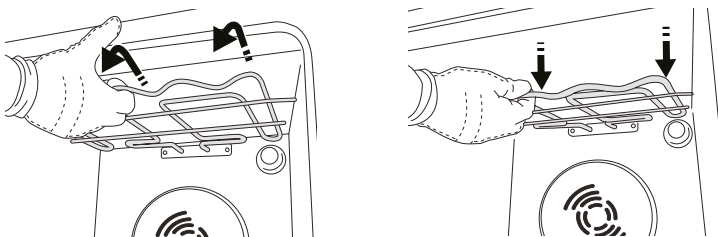

3. Para reposicionar a resistência, levante-a, puxando ligeiramente na sua direção, e certifique-se de que fica assente nos suportes laterais.

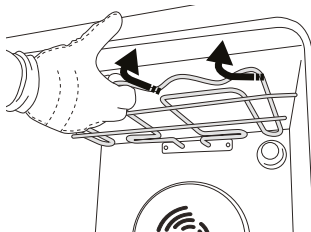

REMOVER E REPOR A PORTA

1. Para remover a porta, abra-a totalmente e baixe as linguetas até ficarem na posição de desbloqueio.

2. Feche a porta tanto quanto possível. Segure firmemente a porta com ambas as mãos – não a segure pela pega.

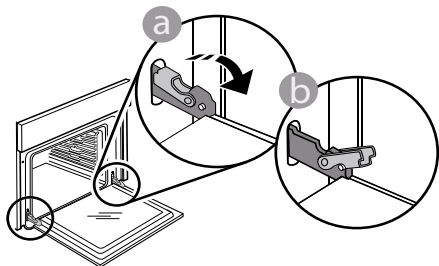

Remova, simplesmente, a porta, continuando a fechá-la enquanto a puxa, simultaneamente, para cima, até se libertar do respetivo suporte. Coloque a porta de parte, apoiando-a sobre uma superfície suave.

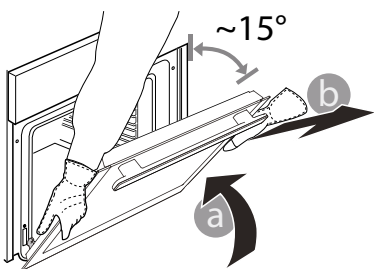

3. Reponha a porta, deslocando-a na direção do forno e alinhando os ganchos das dobradiças com os respetivos suportes, fixando a parte superior aos suportes.

4. Baixe a porta e, em seguida, abra-a totalmente. Baixe as linguetas para a respetiva posição original: Assegure-se de que as baixa totalmente.

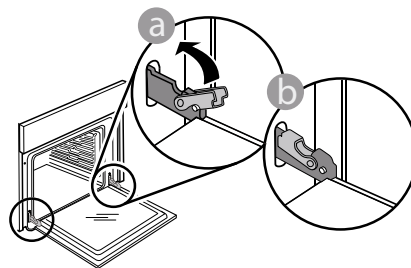

Aplique uma pressão suave, para se assegurar de que as linguetas estão na posição correta.

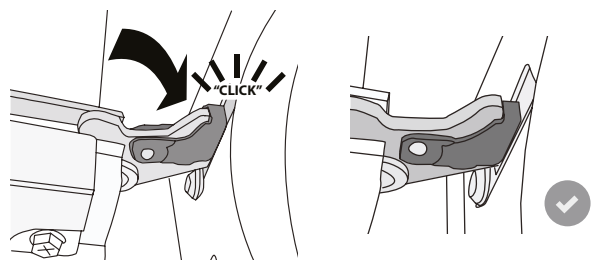

5. Tente fechar a porta e assegure-se de que está alinhada com o painel de controlo. Caso não esteja, repita os procedimentos acima: A porta poderá ficar danificada se não funcionar corretamente.

RESOLUÇÃO DE PROBLEMAS

Problema	Causa possível	Solução
O forno não está a funcionar.	Corte de energia. Desativação da rede elétrica.	Verifique se existe energia elétrica proveniente da rede e se o forno está ligado à tomada elétrica. Desligue e volte a ligar o forno, para verificar se o problema ficou resolvido.
O visor apresenta a letra "F", seguida de um número ou uma letra.	Problema de software.	Contacte o seu Serviço Técnico de Pós-Venda mais próximo e indique o número que acompanha a letra "F".
O monitor mostra um texto pouco claro e parece estar partido.	Definir outro idioma.	Contacte o Centro de Assistência Pós-venda ao Cliente mais próximo.

FICHA DE PRODUTO

 [www](http://www.docs.whirlpool.eu) A ficha do produto contendo os dados energéticos deste aparelho pode ser transferida a partir do website da Whirlpool, em **docs.whirlpool.eu**

COMO OBTER O GUIA DE UTILIZAÇÃO E MANUTENÇÃO

>  [www](http://www.docs.whirlpool.eu) Transfira o Guia de Utilização e Manutenção a partir do nosso website **docs.whirlpool.eu** (pode utilizar este código QR), especificando o código comercial do produto.



> Em alternativa, contacte o nosso Serviço Pós-Venda.

CONTACTAR O NOSSO SERVIÇO PÓS-VENDA

Pode encontrar os nossos contactos no manual de garantia. Ao contactar o nosso Serviço Pós-Venda, indique os códigos fornecidos na placa de identificação do seu produto.

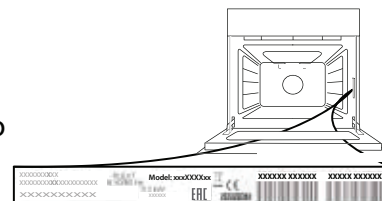

ΟΔΗΓΙΕΣ ΓΙΑ ΤΗΝ ΑΣΦΑΛΕΙΑ

ΣΗΜΑΝΤΙΚΟ! ΔΙΑΒΑΣΤΕ ΚΑΙ ΤΗΡΕΙΤΕ

Διαβάστε τις οδηγίες για την ασφάλεια πριν χρησιμοποιήσετε τη συσκευή. Φυλάξτε τις οδηγίες για μελλοντική αναφορά.

Αυτές οι οδηγίες και η συσκευή περιλαμβάνουν σημαντικές προειδοποιήσεις σχετικά με την ασφάλεια, τις οποίες πρέπει να τηρείτε σε κάθε περίπτωση. Ο κατασκευαστής δεν φέρει καμία ευθύνη για τη μη τήρηση αυτών των οδηγιών ασφαλείας, για ακατάλληλη χρήση της συσκευής ή λανθασμένη ρύθμιση των χειριστηρίων.

⚠ Κρατήστε τα μικρά παιδιά (0-3 ετών) μακριά από η συσκευή. Κρατήστε τα μικρά παιδιά (3-8 ετών) μακριά από η συσκευή εκτός εάν επιτηρούνται διαρκώς. Η συσκευή μπορεί να χρησιμοποιηθεί από παιδιά ηλικίας 8 ετών και άνω ή άτομα με μειωμένες σωματικές, αισθητηριακές ή διανοητικές ικανότητες ή με έλλειψη εμπειρίας και γνώσης της συσκευής, εφόσον βρίσκονται υπό επιτήρηση ή έχουν λάβει οδηγίες σχετικά με την ασφαλή χρήση της συσκευής και κατανοούν τους κινδύνους που συνεπάγεται. Τα παιδιά απαγορεύεται να παίζουν με τη συσκευή. Εργασίες καθαρισμού και συντήρησης του χρήστη δεν πρέπει να εκτελούνται από παιδιά χωρίς επιτήρηση.

⚠ ΠΡΟΕΙΔΟΠΟΙΗΣΗ: Η συσκευή και τα προσβάσιμα εξαρτήματά της θερμαίνονται κατά τη διάρκεια της χρήσης. Προσέξτε να μην αγγίξετε τις αντιστάσεις. Τα παιδιά κάτω των 8 ετών δεν πρέπει να πλησιάζουν τη συσκευή, εκτός εάν επιτηρούνται διαρκώς.

⚠ Μην αφήνετε ποτέ αφύλακτη τη συσκευή κατά την αποξήρανση τροφίμων. Αν η συσκευή είναι κατάλληλη για χρήση του αισθητήρα, χρησιμοποιείτε μόνο έναν αισθητήρα θερμοκρασίας που συστήνεται για το συγκεκριμένο φούρνο - κίνδυνος πυρκαγιάς.

⚠ Διατηρείται τα ρούχα ή άλλα εύφλεκτα υλικά μακριά από τη συσκευή, έως ότου όλα τα εξαρτήματα να έχουν κρυώσει εντελώς - κίνδυνος πυρκαγιάς. Να είστε πάντα σε ετοιμότητα όταν ψήνετε τρόφιμα πλούσια σε λίπος, λάδι ή όταν προσθέτετε αλκοολούχα ποτά - κίνδυνος πυρκαγιάς. Χρησιμοποιείτε γάντια φούρνου για να αφαιρείτε τα ταψιά και τα άλλα εξαρτήματα. Στο τέλος του μαγειρέματος, ανοίξτε την πόρτα προσεκτικά, αφήνοντας το θερμό αέρα ή τον ατμό να βγει σταδιακά πριν να έχετε πρόσβαση στο φούρνο - κίνδυνος εγκαυμάτων. Μην φράζετε τους αεραγωγούς στη μπροστινή πλευρά του φούρνου - κίνδυνος πυρκαγιάς.

⚠ Να είστε προσεκτικοί όταν η πόρτα του φούρνου βρίσκεται σε ανοιχτή θέση ή κατεβασμένη, για να αποφύγετε τη θέρμανση της πόρτας.

ΕΠΙΤΡΕΠΟΜΕΝΗ ΧΡΗΣΗ

⚠ ΠΡΟΣΟΧΗ: Η συσκευή δεν προορίζεται για χρήση σε συνδυασμό με εξωτερικό χρονοδιακόπτη ή ξεχωριστό σύστημα απομακρυσμένου ελέγχου.

⚠ Η συσκευή αυτή έχει σχεδιαστεί για οικιακή χρήση καθώς και για παρόμοιες χρήσεις όπως: κουζίνες χώρων εργασίας σε καταστήματα, γραφεία και άλλα περιβάλλοντα εργασίας, αγροκτήματα, από πελάτες σε ξενοδοχεία, μοτέλ, bed & breakfast και άλλους χώρους κατοικίας.

⚠ Απαγορεύεται οποιαδήποτε άλλη χρήση (π.χ. θέρμανση δωματίων).

⚠ Αυτή η συσκευή δεν προορίζεται για επαγγελματική χρήση. Μην χρησιμοποιείτε τη συσκευή σε εξωτερικό χώρο.

⚠ Μην αποθηκεύετε εκρηκτικές ή εύφλεκτες ουσίες (π.χ. δοχεία βενζίνης ή αερολυμάτων) μέσα ή κοντά στη συσκευή - κίνδυνος πυρκαγιάς.

ΕΓΚΑΤΑΣΤΑΣΗ

⚠ Ο χειρισμός και η εγκατάσταση της συσκευής πρέπει να γίνονται από δύο ή περισσότερα άτομα - κίνδυνος τραυματισμού. Χρησιμοποιείτε γάντια προστασίας για να αφαιρέσετε τη συσκευασία και να κάνετε την εγκατάσταση - κίνδυνος κοψίματος.

⚠ Η εγκατάσταση, συμπεριλαμβανομένης της παροχής νερού (εάν υπάρχει), τις ηλεκτρικές συνδέσεις και τις επισκευές, πρέπει να πραγματοποιούνται από τεχνικά εξειδικευμένο προσωπικό. Μην επισκευάζετε και μην αντικαθιστάτε κανένα εξάρτημα της συσκευής, εκτός εάν αναφέρεται ρητά στο εγχειρίδιο χρήσης. Κρατήστε τα παιδιά μακριά από το χώρο εγκατάστασης. Μετά από την αποσυσκευασία της συσκευής, βεβαιωθείτε ότι δεν έχει προκληθεί ζημιά σε αυτήν κατά τη μεταφορά. Εάν παρουσιαστεί κάποιο πρόβλημα, επικοινωνήστε με τον αντιπρόσωπο ή με το πλησιέστερο Κέντρο Τεχνικής Υποστήριξης. Μετά την εγκατάσταση, τα υλικά συσκευασίας (πλαστικά, φελιζόλ, κ.λπ.) πρέπει να φυλάσσονται μακριά από τα παιδιά - κίνδυνος ασφυξίας. Η συσκευή πρέπει να αποσυνδέεται από την ηλεκτρική τροφοδοσία πριν από κάθε εργασία εγκατάστασης - κίνδυνος ηλεκτροπληξίας. Κατά την εγκατάσταση, βεβαιωθείτε ότι δεν έχει προκληθεί ζημιά στο καλώδιο τροφοδοσίας από τη συσκευή - κίνδυνος πυρκαγιάς ή ηλεκτροπληξίας. Ενεργοποιήστε τη συσκευή μόνο εφόσον ολοκληρωθεί η εγκατάσταση.

⚠ Εκτελέστε όλες τις εργασίες κοπής πριν τοποθετήσετε το φούρνο στο έπιπλο και αφαιρέστε όλα τα ροκανίδια και τα πριονίδια.

Μην φράζετε το ελάχιστο διάκενο ανάμεσα στον πάγκο και το άνω άκρο του φούρνου - κίνδυνος εγκαυμάτων.

Αφαιρείτε το φούρνο από την αφρώδη βάση πολυστυρενίου μόνο τη στιγμή της εγκατάστασης.

⚠ Μετά την εγκατάσταση, δεν θα πρέπει να υπάρχει πλέον πρόσβαση στο κάτω μέρος του φούρνου - κίνδυνος εγκαυμάτων.

⚠ Μην τοποθετείτε τη συσκευή πίσω από διακοσμητική πόρτα - κίνδυνος πυρκαγιάς.

ΗΛΕΚΤΡΙΚΕΣ ΠΡΟΕΙΔΟΠΟΙΗΣΕΙΣ

⚠ Η πινακίδα τεχνικών στοιχείων βρίσκεται στο μπροστινό μέρος του φούρνου (είναι ορατή με την πόρτα ανοιχτή).

⚠ Πρέπει να είναι δυνατή η αποσύνδεση της συσκευής από την ηλεκτρική τροφοδοσία με αφαίρεση του φικς εάν η πρίζα είναι προσβάσιμη ή με χρήση του πολυπολικού διακόπτη που έχει εγκατασταθεί πριν από την πρίζα σύμφωνα με τα εθνικά πρότυπα ηλεκτρικής ασφάλειας και η συσκευή πρέπει να διαθέτει γείωση με βάση τα εθνικά πρότυπα ασφαλείας.

⚠ Μην χρησιμοποιείτε καλώδια προέκτασης (μπαλαντέζες), πολύπριζα ή προσαρμογείς. Μετά την ολοκλήρωση της εγκατάστασης, δεν πρέπει να είναι δυνατή η πρόσβαση στα ηλεκτρικά εξαρτήματα. Μην χρησιμοποιείτε τη συσκευή όταν είστε βρεγμένος ή με γυμνά πόδια. Μην χρησιμοποιήσετε τη συσκευή εάν έχει φθαρεί το ηλεκτρικό καλώδιο ή το φικς, εάν δεν λειτουργεί κανονικά, εάν έχει πέσει ή εάν έχει υποστεί άλλη ζημιά.

⚠ Εάν το καλώδιο τροφοδοσίας έχει υποστεί ζημιά, πρέπει να αντικατασταθεί από τον κατασκευαστή, τον αντιπρόσωπο τεχνικής υποστήριξης ή άλλα καταρτισμένα άτομα, ώστε να αποφευχθούν τυχόν κίνδυνοι - κίνδυνος ηλεκτροπληξίας.

⚠ Σε περίπτωση αντικατάστασης του καλωδίου τροφοδοσίας, επικοινωνήστε με ένα εξουσιοδοτημένο κέντρο σέρβις.

ΚΑΘΑΡΙΣΜΟΣ ΚΑΙ ΣΥΝΤΗΡΗΣΗ

⚠ ΠΡΟΕΙΔΟΠΟΙΗΣΗ: Πριν από οποιαδήποτε εργασία συντήρησης, βεβαιωθείτε ότι η συσκευή είναι σβηστή και αποσυνδεδεμένη από το δίκτυο τροφοδοσίας. Ποτέ μην χρησιμοποιείτε συσκευές καθαρισμού με ατμό - κίνδυνος ηλεκτροπληξίας.

⚠ Μην χρησιμοποιείτε σκληρά, αποξεστικά καθαριστικά ή αιχμηρές μεταλλικές ξύστρες για να καθαρίσετε το κρύσταλλο στην πόρτα του φούρνου. Κάτι τέτοιο μπορεί να χαράξει την επιφάνεια και πιθανώς να προκαλέσει θραύση του κρυστάλλου.

⚠ Βεβαιωθείτε ότι η συσκευή έχει κρυώσει πριν διεξάγετε οποιαδήποτε εργασία καθαρισμού ή συντήρησης - κίνδυνος εγκαυμάτων.

⚠ ΠΡΟΕΙΔΟΠΟΙΗΣΗ: Πριν αντικαταστήσετε το λαμπτήρα, απενεργοποιήστε τη συσκευή - κίνδυνος ηλεκτροπληξίας.

ΑΠΟΡΡΙΨΗ ΥΛΙΚΩΝ ΣΥΣΚΕΥΑΣΙΑΣ

Τα υλικά της συσκευασίας είναι 100% ανακυκλώσιμα και φέρουν το σύμβολο της ανακύκλωσης ♻.

Τα διάφορα μέρη της συσκευασίας πρέπει συνεπώς να απορρίπτονται με υπευθυνότητα και σε πλήρη συμμόρφωση με τους κανονισμούς της τοπικής δημοτικής αρχής όσον αφορά τη διάθεση αποβλήτων.

ΑΠΟΡΡΙΨΗ ΗΛΕΚΤΡΙΚΩΝ ΟΙΚΙΑΚΩΝ ΣΥΣΚΕΥΩΝ

Η συσκευή αυτή έχει κατασκευαστεί από ανακυκλώσιμα ή επαναχρησιμοποιήσιμα υλικά. Απορρίψτε σύμφωνα με τους κανονισμούς των τοπικών αρχών. Για περαιτέρω πληροφορίες σχετικά με την επεξεργασία, την ανάκτηση και την ανακύκλωση των ηλεκτρικών οικιακών συσκευών, επικοινωνήστε με τις αρμόδιες τοπικές αρχές, την υπηρεσία συλλογής οικιακών αποβλήτων ή το κατάστημα από όπου αγοράσατε αυτό το προϊόν. Αυτή η συσκευή επισημαίνεται σύμφωνα με την Ευρωπαϊκή Οδηγία 2012/19/ΕΕ, Απόβλητα Ηλεκτρικού και Ηλεκτρονικού Εξοπλισμού (ΑΗΗΕ) και με τους κανονισμούς 2013 για τα Απόβλητα Ηλεκτρικού και Ηλεκτρονικού Εξοπλισμού (όπως τροποποιήθηκε).

Εξασφαλίζοντας τη σωστή απόρριψη αυτού του προϊόντος, θα βοηθήσετε στην αποτροπή των πιθανά βλαβερών συνεπειών για το περιβάλλον και την ανθρώπινη υγεία.

Το σύμβολο  πάνω στο προϊόν ή στα έγγραφα που το συνοδεύουν υποδεικνύει ότι αυτή η συσκευή δεν μπορεί να θεωρηθεί οικιακό απόρριμμα. Αντί γι' αυτό, θα πρέπει να παραδοθεί στο κατάλληλο σημείο περισυλλογής για την ανακύκλωση ηλεκτρικών και ηλεκτρονικών εξαρτημάτων.

ΣΥΜΒΟΥΛΕΣ ΓΙΑ ΕΞΟΙΚΟΝΟΜΗΣΗ ΕΝΕΡΓΕΙΑΣ

Προθερμάνετε το φούρνο μόνο εάν αυτό αναφέρεται στον πίνακα μαγειρέματος ή στη συνταγή σας. Χρησιμοποιήστε φόρμες με σκουρόχρωμο βερνίκι ή εμαγιέ επειδή απορροφούν πολύ καλύτερα τη θερμότητα. Τα φαγητά που απαιτούν παρατεταμένο ψήσιμο θα συνεχίσουν να ψήνονται ακόμη και μετά το σβήσιμο του φούρνου.

ΔΗΛΩΣΗ ΟΙΚΟΛΟΓΙΚΗΣ ΣΧΕΔΙΑΣΗΣ

Αυτή η συσκευή πληροί: Απαιτήσεις οικολογικού σχεδιασμού του Ευρωπαϊκού Κανονισμού 66/2014. Κανονισμός Ενεργειακής Σήμανσης 65/2014. Οικολογικός σχεδιασμός για σχετικά με την ενέργεια προϊόντα και ενεργειακές πληροφορίες (Τροποποίηση) (EE Exit) Κανονισμοί 2019, σύμφωνα με το Ευρωπαϊκό πρότυπο EN 60350-1.

ΚΑΘΗΜΕΡΙΝΟΣ ΟΔΗΓΟΣ ΑΝΑΦΟΡΑΣ



ΣΑΣ ΕΥΧΑΡΙΣΤΟΥΜΕ ΠΟΥ ΑΓΟΡΑΣΑΤΕ ΕΝΑ ΠΡΟΪΟΝ WHIRLPOOL

Προκειμένου να λαμβάνετε ολοκληρωμένη βοήθεια και υποστήριξη, καταχωρίστε το προϊόν σας στην ιστοσελίδα www.whirlpool.eu/register



Μπορείτε να κατεβάσετε τις “Οδηγίες ασφάλειας” και τον “Οδηγός χρήσης και φροντίδας” από την ιστοσελίδα docs.whirlpool.eu και ακολουθώντας τις οδηγίες στην πίσω πλευρά του παρόντος εγχειριδίου.

! Πριν χρησιμοποιήσετε τη συσκευή, διαβάστε προσεκτικά τον “Οδηγό υγείας και ασφάλειας”.

ΠΕΡΙΓΡΑΦΗ ΠΡΟΪΟΝΤΟΣ

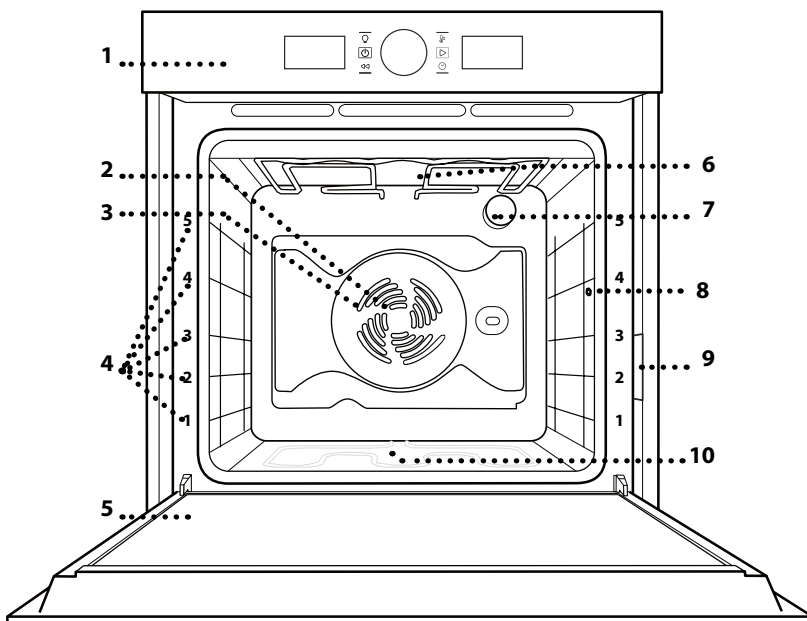

1. Πίνακας ελέγχου
2. Ανεμιστήρας
3. Κυκλική αντίσταση (δεν είναι ορατή)
4. Οδηγοί ραφιού (το επίπεδο υποδεικνύεται στη μπροστινή πλευρά του φούρνου)
5. Πόρτα
6. Επάνω αντίσταση/γκριλ
7. Λαμπτήρας
8. Σημείο εισαγωγής αισθητήρα κρέατος (εάν υπάρχει)
9. Πινακίδα αναγνώρισης (να μην αφαιρείται)
10. Κάτω αντίσταση (δεν φαίνεται)

ΠΙΝΑΚΑΣ ΕΛΕΓΧΟΥ

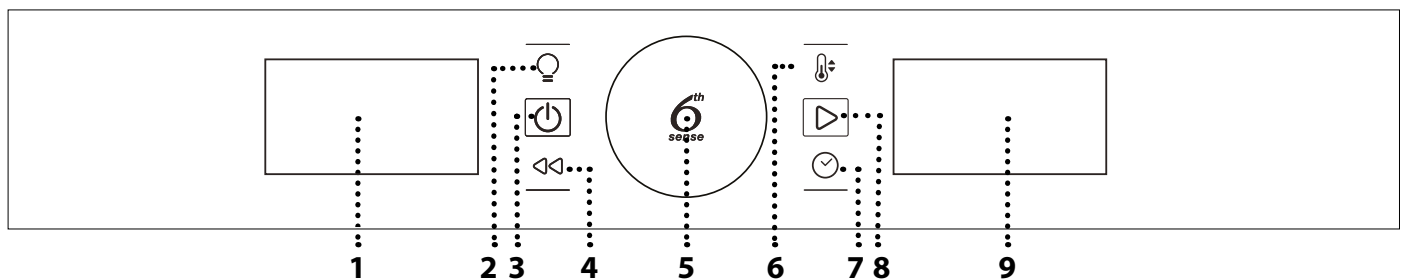

1. ΑΡΙΣΤΕΡΗ ΟΘΟΝΗ

2. ΦΩΣ

Για ενεργοποίηση/Απενεργοποίηση της λάμπας.

3. ΑΝΑΜΜΑ/ΣΒΗΣΙΜΟ

Για το άναμμα ή το σβήσιμο του φούρνου και για την παύση ή τη διακοπή μιας ενεργής λειτουργίας.

4. ΠΙΣΩ

Για επιστροφή στο προηγούμενο μενού όταν κάνετε τις ρυθμίσεις.

5. ΠΕΡΙΣΤΡΟΦΙΚΟ ΚΟΥΜΠΙ/ ΚΟΥΜΠΙ 6TH SENSE

Γυρίστε το για να πλοηγηθείτε στις λειτουργίες και να ρυθμίσετε όλες τις παραμέτρους μαγειρέματος. Πατήστε  για να επιλέξετε, να ρυθμίσετε, να έχετε πρόσβαση και να επιβεβαιώσετε λειτουργίες και παραμέτρους, καθώς και για να εκκινήσετε το πρόγραμμα μαγειρέματος.

6. ΘΕΡΜΟΚΡΑΣΙΑ

Για ρύθμιση της θερμοκρασίας.

7. ΧΡΟΝΟΣ

Για ρύθμιση ή αλλαγή της ώρας και για ρύθμιση του χρόνου ψησίματος.

8. ΕΝΑΡΞΗ

Για έναρξη λειτουργιών και επιβεβαίωση ρυθμίσεων.

9. ΔΕΞΙΑ ΟΘΟΝΗ

ΑΞΕΣΟΥΑΡ

ΣΧΑΡΑ

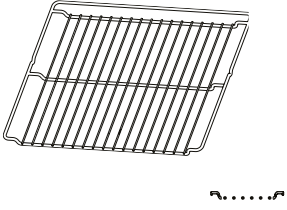

ΛΙΠΟΣΥΛΛΕΚΤΗΣ

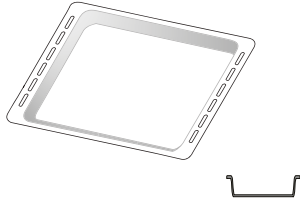

ΤΑΨΙ ΨΗΣΙΜΑΤΟΣ

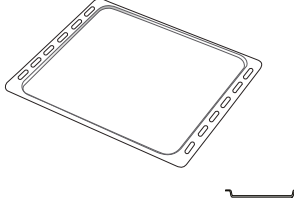

ΣΥΡΟΜΕΝΟΙ ΟΔΗΓΟΙ (ΜΟΝΟ ΣΕ ΟΡΙΣΜΕΝΑ ΜΟΝΤ)

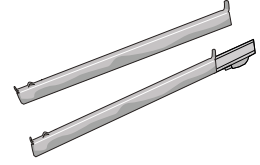

ΘΕΡΜ ΚΡΕΑΤΟΣ (ΜΟΝΟ ΣΕ ΟΡΙΣΜΕΝΑ ΜΟΝΤΕΛΑ)

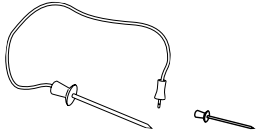

Ο αριθμός των αξεσουάρ μπορεί να διαφέρει ανάλογα με το μοντέλο που αγοράσατε. Άλλα αξεσουάρ μπορούν να αγοραστούν χωριστά από το κέντρο εξυπηρέτησης πελατών.

ΤΟΠΟΘΕΤΗΣΗ ΤΗΣ ΣΧΑΡΑΣ ΚΑΙ ΑΛΛΩΝ ΕΞΑΡΤΗΜΑΤΩΝ

Τοποθετήστε τη σχάρα οριζόντια σύροντας στους οδηγούς του ραφιού και βεβαιωθείτε ότι η πλευρά με το ανυψωμένο άκρο είναι γυρισμένη προς τα επάνω.

Τα άλλα αξεσουάρ, όπως το ταψί για λίπη και το ταψί ψησίματος, τοποθετούνται οριζόντια με τον ίδιο τρόπο όπως η σχάρα.

ΑΦΑΙΡΕΣΗ ΚΑΙ ΕΠΑΝΑΤΟΠΟΘΕΤΗΣΗ ΟΔΗΓΩΝ ΡΑΦΙΟΥ

Δείτε τις εικόνες για να αφαιρέσετε τα πλαϊνά στηρίγματα και (εάν υπάρχουν) τα παξιμάδια του φούρνου που τα συγκρατούν

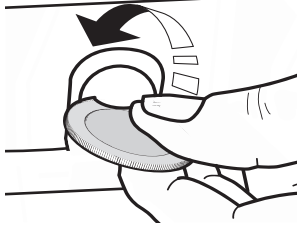
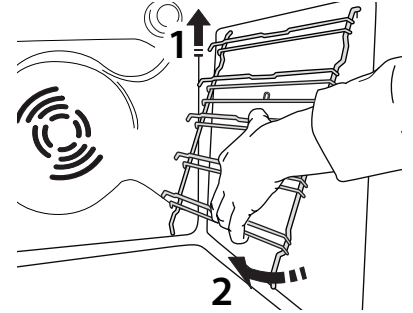
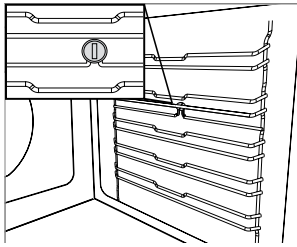

ΕΦΑΡΜΟΓΗ ΤΩΝ ΚΙΝΗΤΩΝ ΟΔΗΓΩΝ

(ΕΦΟΣΟΝ ΔΙΑΤΙΘΕΝΤΑΙ)

Αφαιρέστε τους οδηγούς ραφιών από το φούρνο και αφαιρέστε το προστατευτικό πλαστικό από τους κινητούς οδηγούς.

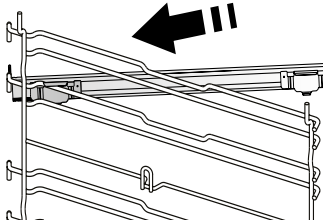

Σφίξτε το άνω κλιπ του κινητού οδηγού στον οδηγό ραφιού και σύρετε τον μέχρι τέρμα. Κατεβάστε το άλλο κλιπ στη θέση τους.

Για να ασφαλίσει ο οδηγός, πιέστε το κάτω τμήμα του κλιπ προς τον οδηγό ραφιού. Βεβαιωθείτε ότι οι κινητοί οδηγοί μπορούν να κινηθούν ελεύθερα. Επαναλάβετε τα βήματα στον άλλο οδηγό ραφιού στο ίδιο επίπεδο.

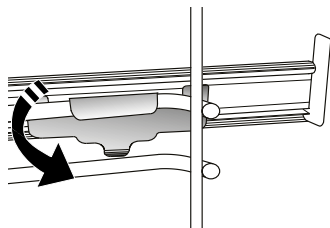

Για να τοποθετήσετε ξανά τους οδηγούς ραφιών, πρώτα τοποθετήστε τους στην άνω υποδοχή. Κρατώντας τους σηκωμένους, σύρετε μέσα στο θάλαμο ψησίματος και κατεβάστε τους στη θέση τους στις κάτω υποδοχές.

Σημείωση: Οι κινητοί οδηγοί μπορούν να τοποθετηθούν σε οποιοδήποτε ράφι.

ΛΕΙΤΟΥΡΓΙΕΣ

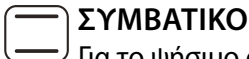

ΣΥΜΒΑΤΙΚΟ

Για το ψήσιμο οποιουδήποτε είδους φαγητού σε ένα μόνο ράφι.



ΓΚΡΙΛ

Για να ψήσετε στο grill μπριζόλες, σουβλάκια, λουκάνικα, λαχανικά gratin, καθώς και για να φρυγανίσετε ψωμί. Όταν ψήνετε κρέας στο γκριλ, συνιστάται να χρησιμοποιείτε το λιποσυλλέκτη για τη συλλογή των χυμών ψησίματος: Τοποθετήστε το ταψί σε οποιοδήποτε επίπεδο κάτω από τη σχάρα και προσθέστε 500 ml πόσιμο νερό.



ΕΞΑΝΑΓΚ. ΑΕΡΑΣ

Για το μαγείρεμα διαφορετικών φαγητών που απαιτούν την ίδια θερμοκρασία μαγειρέματος σε διαφορετικά ράφια (έως τρία) ταυτόχρονα. Αυτή η λειτουργία μπορεί να χρησιμοποιηθεί για το ψήσιμο διαφορετικών φαγητών χωρίς να μεταφέρονται οσμές από το ένα φαγητό στο άλλο.



ΣΥΜΒΑΤΙΚΟ ΨΗΣΙΜΟ

Για το ψήσιμο κρέατος, κέικ με γέμιση ή για το ψήσιμο γεμιστών λαχανικών μόνο στη σχάρα. Η λειτουργία αυτή χρησιμοποιεί ήπια, διακοπτόμενη κυκλοφορία αέρα ώστε να μην στεγνώσει υπερβολικά το φαγητό.



ΛΕΙΤΟΥΡΓΙΕΣ 6TH SENSE



ΤΗΣ ΚΑΤΣΑΡΟΛΑΣ

Αυτή η λειτουργία επιλέγει αυτόματα την καλύτερη θερμοκρασία και τρόπο ψησίματος για πιάτα ζυμαρικών.



ΚΡΕΑΣ

Αυτή η λειτουργία επιλέγει αυτόματα την καλύτερη θερμοκρασία και τρόπο ψησίματος για το κρέας. Η λειτουργία αυτή κατά διαστήματα ενεργοποιεί τον ανεμιστήρα στη χαμηλή ταχύτητα για να εμποδίσει το φαγητό να στεγνώσει πολύ.



ΜΑΓΕΙΡΕΜΑ MAXI

Η λειτουργία επιλέγει αυτόματα την καλύτερη λειτουργία μαγειρέματος και την καταλληλότερη θερμοκρασία για το μαγείρεμα μεγάλων κομματιών κρέατος (πάνω από 2,5 κιλά). Για ομοιόμορφο ροδοκοκκίνισμα και στις δύο πλευρές, συνιστάται να γυρίσετε το κρέας κατά το ψήσιμο. Είναι καλό να περιχύνετε το κρέας με ζωμό σε τακτά χρονικά διαστήματα για να μη στεγνώσει.



ΨΩΜΙ

Αυτή η λειτουργία επιλέγει αυτόματα την καλύτερη θερμοκρασία και τρόπο ψησίματος για όλους τους τύπους ψωμιού.



ΠΙΤΣΑ

Αυτή η λειτουργία επιλέγει αυτόματα την καλύτερη θερμοκρασία και τρόπο ψησίματος για όλους τους τύπους πίτσας.



ΓΛΥΚΑ ΚΕΪΚ

Αυτή η λειτουργία επιλέγει αυτόματα την καλύτερη θερμοκρασία και τρόπο ψησίματος για όλους τους τύπους κέικ.



ΕΙΔ. ΛΕΙΤΟΥΡΓ.



ΓΡΗΓ. ΠΡΟΘΕΡΜ.

Για τη γρήγορη προθέρμανση του φούρνου. Μόλις ολοκληρωθεί η προθέρμανση, ο φούρνος θα χρησιμοποιήσει αυτόματα τη "Συμβατικό" λειτουργία. Πριν τοποθετήσετε το φαγητό μέσα στο φούρνο, περιμένετε να ολοκληρωθεί η προθέρμανση.



ΓΚΡΙΛ ΤΟΥΡΜΠΟ

Για να ψήσετε μεγάλα κομμάτια κρέατος (μπούτια, ροσμπίφ, κοτόπουλο). Συνιστάται να χρησιμοποιείτε το ταψί λίπους για τη συλλογή των χυμών ψησίματος: Τοποθετήστε το ταψί σε οποιοδήποτε επίπεδο κάτω από τη σχάρα και προσθέστε 500 ml πόσιμο νερό. Η σουβλα (εάν παρέχεται) μπορεί να χρησιμοποιηθεί με αυτή τη λειτουργία.



ΕΞΑΝ. ΑΕΡΑΣ ECO*

Για το ψήσιμο γεμιστών κομματιών και φιλετών κρέατος σε ένα μόνο ράφι. Το στέγνωμα του φαγητού αποτρέπεται με διακεκομμένη, απαλή κυκλοφορία αέρα. Όταν χρησιμοποιείται η οικονομική λειτουργία ECO, το φωτάκι θα παραμείνει σβηστό κατά τη διάρκεια ψησίματος. Για να χρησιμοποιήσετε τον κύκλο ECO (Οικονομικό) και κατά συνέπεια να βελτιώσετε την κατανάλωση ρεύματος, η πόρτα του φούρνου δεν πρέπει να ανοίξει έως ότου το φαγητό να είναι εντελώς μαγειρεμένο.



ΔΙΑΤΗΡΗΣΗ ΘΕΡΜΟ

Για να διατηρήσετε ζεστό και τραγανό το φαγητό που μόλις ψήσατε.



ΦΟΥΣΚΩΜΑ

Για το ιδανικό φούσκωμα γλυκιάς ή αλμυρής ζύμης. Για να εξασφαλίσετε την ποιότητα φουσκώματος, μην ενεργοποιείτε τη λειτουργία αν ο φούρνος είναι ακόμη ζεστός μετά από έναν κύκλο ψησίματος.



SMART CLEAN

(ΜΟΝΟ ΣΕ ΟΡΙΣΜΕΝΑ ΜΟΝΤΕΛΑ)

Η δράση του ατμού που απελευθερώνεται κατά τον ειδικό κύκλο καθαρισμού με χαμηλή θερμοκρασία, επιτρέπει την εύκολη αφαίρεση της βρωμιάς και των υπολειμμάτων τροφίμων. Ρίξτε 200 ml πόσιμο νερό στην κάτω επιφάνεια του φούρνου και ενεργοποιήστε τη λειτουργία όταν ο φούρνος κρυώσει.

* Λειτουργία που χρησιμοποιείται ως αναφορά για την δήλωση ενεργειακής απόδοσης σύμφωνα με τον κανονισμό (ΕΕ) Αρ. 65/2014

ΧΡΗΣΗ ΤΗΣ ΣΥΣΚΕΥΗΣ ΓΙΑ ΠΡΩΤΗ ΦΟΡΑ

1. ΡΥΘΜΙΣΤΕ ΤΗΝ ΩΡΑ

Θα χρειαστεί να ρυθμίσετε την ώρα όταν ανάψετε τη συσκευή για πρώτη φορά.



Τα δύο ψηφία της ώρας θα αρχίσουν να αναβοσβήνουν: Περιστρέψτε το κουμπί ρύθμισης για να ρυθμίσετε την ώρα και πιέστε το για επιβεβαίωση.



Τα δύο ψηφία των λεπτών θα αρχίσουν να αναβοσβήνουν. Περιστρέψτε το κουμπί ρύθμισης για να ρυθμίσετε τα λεπτά και πιέστε το για επιβεβαίωση.

Σημείωση: Για να αλλάξετε την ώρα σε δεύτερο χρόνο, κρατήστε πατημένο το για τουλάχιστον ένα δευτερόλεπτο με το φούρνο σβηστό και επαναλάβετε τα πιο πάνω βήματα. Ενδέχεται να χρειαστεί να ρυθμίσετε ξανά την ώρα έπειτα από διακοπές ρεύματος μεγάλης διάρκειας.

2. ΡΥΘΜΙΣΕΙΣ

Αν απαιτείται, μπορείτε να αλλάξετε την προεπιλεγμένη μονάδα μέτρησης, τη θερμοκρασία (°C) και το ονομαστικό ρεύμα (16 A).

Με το φούρνο σβηστό, κρατήστε πατημένο το για τουλάχιστον 5 δευτερόλεπτα.



Περιστρέψτε το κουμπί επιλογής για να επιλέξετε τη μονάδα μέτρησης, στη συνέχεια πιέστε το για επιβεβαίωση.



Περιστρέψτε το κουμπί επιλογής για να επιλέξετε το ονομαστικό ρεύμα, στη συνέχεια πιέστε το για επιβεβαίωση.

Σημείωση: Ο φούρνος είναι προγραμματισμένος να καταναλώνει ηλεκτρική ενέργεια σε επίπεδο συμβατό με το οικιακό δίκτυο με ισχύ μεγαλύτερη από 3 kW (16 A): Αν στην οικία σας χρησιμοποιείται χαμηλότερη ισχύς, θα χρειαστεί να την μειώσετε την ισχύ (13 A).

3. ΘΕΡΜΑΝΣΗ ΦΟΥΡΝΟΥ

Ένας καινούργιος φούρνος μπορεί να εκλύει οσμές που έχουν παραμείνει από την διαδικασία κατασκευής: Αυτό είναι απόλυτα φυσιολογικό.

Πριν ξεκινήσετε το ψήσιμο φαγητού, συνιστάται να ζεσταίνετε το φούρνο άδειο έτσι ώστε να απομακρυνθούν τυχόν οσμές.

Αφαιρέστε τα χαρτόνια ή τυχόν πλαστικό φιλμ από το φούρνο και αφαιρέστε από μέσα τα εξαρτήματα. Θερμάνετε το φούρνο στους 200 °C για περίπου μία ώρα, χρησιμοποιώντας καλύτερα τη λειτουργία κυκλοφορίας αέρα (π.χ. "Εξαναγκ. αέρας" ή "Συμβ. ψήσιμο").

Ακολουθήστε τις οδηγίες για τη σωστή ρύθμιση της λειτουργίας.

Σημείωση: Συνιστάται να αερίσετε το χώρο μετά τη χρήση της συσκευής για πρώτη φορά.

ΚΑΘΗΜΕΡΙΝΗ ΧΡΗΣΗ

1. ΕΠΙΛΟΓΗ ΛΕΙΤΟΥΡΓΙΑΣ

Όταν ο φούρνος είναι σβηστός, στην οθόνη εμφανίζεται μόνο η ώρα. Κρατήστε πατημένο το για να ανάψετε το φούρνο. Περιστρέψτε το κουμπί για να δείτε τις διαθέσιμες λειτουργίες στην αριστερή οθόνη. Επιλέξτε μία και πιέστε το .

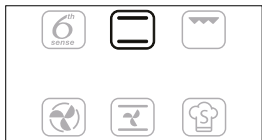

Για να επιλέξετε μια δευτερεύουσα λειτουργία (όπου διατίθεται), επιλέξτε την κύρια λειτουργία και στη συνέχεια πατήστε το για επιβεβαίωση και για να μεταβείτε στο μενού λειτουργιών.

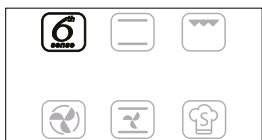

Περιστρέψτε το κουμπί για να δείτε τις διαθέσιμες δευτερεύουσες λειτουργίες στη δεξιά οθόνη. Επιλέξτε μία και πιέστε το για επιβεβαίωση.

2. ΡΥΘΜΙΣΤΕ ΤΗ ΛΕΙΤΟΥΡΓΙΑ

Αφού επιλέξετε τη λειτουργία που θέλετε, μπορείτε να αλλάξετε τις ρυθμίσεις.

Στην οθόνη θα εμφανιστούν οι ρυθμίσεις που μπορούν να αλλάξουν διαδοχικά.

ΕΠΙΠΕΔΟ ΘΕΡΜΟΚΡΑΣΙΑΣ/ΓΚΡΙΑ

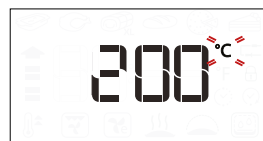

Όταν το εικονίδιο °C/°F αναβοσβήνει στην οθόνη, περιστρέψτε τον επιλογέα για να αλλάξετε την τιμή, μετά πατήστε το για επιβεβαίωση και συνεχίστε για να αλλάξετε τις ρυθμίσεις που ακολουθούν (εφόσον αυτό είναι δυνατό).

Μπορείτε επίσης να ρυθμίσετε ταυτόχρονα και το επίπεδο του γκριλ (3 = υψηλό, 2 = μεσαίο, 1 = χαμηλό).



Σημείωση: Μόλις ξεκινήσει η λειτουργία, μπορείτε να αλλάξετε τη θερμοκρασία ή το επίπεδο του γκριλ πατώντας το ή περιστρέφοντας απευθείας το κουμπί.

ΔΙΑΡΚΕΙΑ

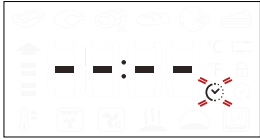

Όταν αναβοσβήνει το εικονίδιο στην οθόνη, χρησιμοποιήστε τον επιλογέα ρύθμισης για να ρυθμίσετε το χρόνο που απαιτείται για να ολοκληρωθεί το μαγείρεμα, στη συνέχεια πατήστε το για επιβεβαίωση. Δεν είναι απαραίτητο να ρυθμίσετε το χρόνο μαγειρέματος αν σκοπεύετε να χειριστείτε το μαγείρεμα χειροκίνητα: Πατήστε το για επιβεβαίωση και τη λειτουργία έναρξης.

Σε αυτή την περίπτωση, δεν μπορείτε να ρυθμίσετε το χρόνο τέλους μαγειρέματος προγραμματίζοντας μια καθυστερημένη έναρξη.

Σημείωση: Μπορείτε να προσαρμόσετε το χρόνο μαγειρέματος που ρυθμίστηκε κατά τη διάρκεια μαγειρέματος πιέζοντας το : Περιστρέψτε το κουμπί για να αλλάξετε την ώρα και πιέστε το για επιβεβαίωση.

ΡΥΘΜΙΣΗ ΧΡΟΝΟΥ ΤΕΛΟΥΣ ΨΗΣΙΜΑΤΟΣ (ΚΑΘΥΣΤΕΡΗΣΗ ΕΝΑΡΞΗΣ)

Σε πολλές λειτουργίες, μόλις ρυθμίσετε το χρόνο μαγειρέματος μπορείτε να καθυστερήσετε την έναρξη της λειτουργίας προγραμματίζοντας το χρόνο τέλους. Όταν μπορείτε να αλλάξετε το χρόνο τέλους, στην οθόνη εμφανίζεται η ώρα στην οποία αναμένεται να τελειώσει το ψήσιμο ενώ το εικονίδιο αναβοσβήνει.



Αν είναι απαραίτητο, περιστρέψτε το κουμπί για να ρυθμίσετε την ώρα που θέλετε να τελειώσει το ψήσιμο, μετά πατήστε το για επιβεβαίωση και για να ξεκινήσει η λειτουργία.

Βάλτε το φαγητό στο φούρνο και κλείστε την πόρτα: Η λειτουργία θα ξεκινήσει αυτόματα μετά από το χρονικό διάστημα που υπολογίστηκε προκειμένου να τερματιστεί το μαγείρεμα στο χρόνο που επιλέξατε.



Σημείωση: Ο προγραμματισμός χρόνου καθυστέρησης έναρξης ψησίματος απενεργοποιεί πάντα την φάση προθέρμανσης του φούρνου. Ο φούρνος θα φτάσει στην επιθυμητή θερμοκρασία βαθμιαία, κάτι που σημαίνει ότι οι χρόνοι μαγειρέματος θα είναι ελαφρώς μεγαλύτεροι από αυτούς που αναγράφονται στον πίνακα μαγειρέματος. Κατά το χρόνο αναμονής, μπορείτε να χρησιμοποιήσετε το κουμπί για να αλλάξετε τον προγραμματισμένο χρόνο τέλους. Πατήστε το ή το για να αλλάξετε τις ρυθμίσεις θερμοκρασίας και χρόνου ψησίματος. Πιέστε για επιβεβαίωση όταν τελειώσετε.

Σημείωση: Η λειτουργία καθυστέρησης έναρξης δεν είναι διαθέσιμη για τις λειτουργίες Grill και Turbo Grill.

3. ΕΝΕΡΓΟΠΟΙΗΣΗ ΛΕΙΤΟΥΡΓΙΑΣ

Μόλις εφαρμόσετε όλες τις ρυθμίσεις που θέλετε, πιέστε το για να ενεργοποιηθεί η λειτουργία.

Μπορείτε να κρατήσετε πατημένο το οποιαδήποτε στιγμή για παύση της τρέχουσας λειτουργίας που είναι ενεργή.

4. ΠΡΟΘΕΡΜΑΝΣΗ

Ορισμένες λειτουργίες έχουν μια φάση προθέρμανσης: Μόλις ξεκινήσει η λειτουργία, η οθόνη δείχνει ότι ενεργοποιήθηκε η λειτουργία προθέρμανσης.



Μόλις ολοκληρωθεί αυτή η φάση, εκπέμπεται ένα ηχητικό σήμα και στην οθόνη εμφανίζεται η ένδειξη ότι ο φούρνος έφτασε στην επιλεγμένη θερμοκρασία.



Στο σημείο αυτό, ανοίξτε την πόρτα, τοποθετήστε το φαγητό στο φούρνο, κλείστε το φούρνο και ξεκινήστε το μαγείρεμα πατώντας το .

Σημείωση: Η τοποθέτηση του φαγητού στο φούρνο πριν ολοκληρωθεί η προθέρμανση ενδέχεται να έχει ανεπιθύμητα αποτελέσματα για το τελικό ψήσιμο.

Το άνοιγμα της πόρτας κατά τη φάση προθέρμανσης θα σταματήσει τη λειτουργία.

Ο χρόνος μαγειρέματος δεν περιλαμβάνει τη φάση προθέρμανσης.

Μπορείτε πάντα να αλλάξετε τη θερμοκρασία που θέλετε να επιτύχετε χρησιμοποιώντας το κουμπί.

5. ΤΕΛΟΣ ΜΑΓΕΙΡΕΜΑΤΟΣ

Εκπέμπεται ένα ηχητικό σήμα και στην οθόνη εμφανίζεται η ένδειξη ότι το μαγείρεμα ολοκληρώθηκε.



Για να παρατείνετε το χρόνο ψησίματος χωρίς να αλλάξετε τις ρυθμίσεις, περιστρέψτε το κουμπί για να ρυθμίσετε ένα νέο χρόνο ψησίματος και πατήστε το .

. ΛΕΙΤΟΥΡΓΙΕΣ 6th SENSE

ΕΠΑΝΑΦΟΡΑ ΘΕΡΜΟΚΡΑΣΙΑΣ

Αν η θερμοκρασία στο φούρνο μειώνεται κατά τη διάρκεια ενός κύκλου επειδή άνοιξε η πόρτα, ενεργοποιείται αυτόματα μια ειδική λειτουργία που επαναφέρει την αρχική θερμοκρασία.

Ενώ επαναφέρεται η θερμοκρασία, στην οθόνη εμφανίζεται ένα κινούμενο γραφικό με ένα "φίδι" έως ότου επιτευχθεί η επιλεγμένη θερμοκρασία.

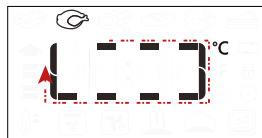





Ενώ βρίσκεται σε εξέλιξη ένας προγραμματισμένος κύκλος ψησίματος, ο χρόνος ψησίματος θα αυξηθεί ανάλογα με το διάστημα που κρατήθηκε ανοιχτή η πόρτα, προκειμένου να εξασφαλιστεί το τελικό αποτέλεσμα.

. ΕΙΔΙΚΕΣ ΛΕΙΤΟΥΡΓΙΕΣ

SMART CLEAN

Για να ενεργοποιήσετε τη λειτουργία "Smart Clean", με το φούρνο κρύο, διασκορπίστε 200 ml νερό στην κάτω επιφάνεια του φούρνου και κλείστε την πόρτα του φούρνου.

Αποκτήστε πρόσβαση στις ειδικές λειτουργίες  και περιστρέψτε τον επιλογέα για να επιλέξετε  από το μενού και μετά πατήστε  για επιβεβαίωση.

Πατήστε το  για να ξεκινήσει αμέσως ο κύκλος καθαρισμού ή πατήστε το  για να επιλέξετε το χρόνο τέλους/έναρξη καθυστ.

Στο τέλος του κύκλου, αφαιρέστε το νερό που έχει παραμείνει στο φούρνο και καθαρίστε το φούρνο με ένα σφουγγάρι που είναι εμποτισμένο με ζεστό νερό (ο καθαρισμός μπορεί να μην είναι αποτελεσματικός εάν καθυστερήσει περισσότερο από 15 λεπτά).

Σημείωση: Η διάρκεια του κύκλου καθαρισμού δεν μπορεί να ρυθμιστεί

. ΧΡΗΣΗ ΤΟΥ ΑΙΣΘΗΤΗΡΑ ΚΡΕΑΤΟΣ (ΕΑΝ ΥΠΑΡΧΕΙ)

Ο παρεχόμενος αισθητήρας κρέατος επιτρέπει να μετρηθεί η ακριβής θερμοκρασία των τροφίμων κατά τη διάρκεια μαγειρέματος.

Η χρήση του αισθητήρα κρέατος επιτρέπεται μόνο για ορισμένες λειτουργίες μαγειρέματος, εξαναγκασμένου αέρα, συμβατικό μαγείρεμα, Γκριλ τούρμπο, 6th Sense κρέας και 6th Sense Maxicooking).

Είναι πολύ σημαντικό να τοποθετήσετε τον αισθητήρα με ακρίβεια προκειμένου να έχετε τα βέλτιστα αποτελέσματα. Εισαγάγετε τον αισθητήρα πλήρως μέσα στο πιο ψαχνό μέρος του κρέατος, αποφεύγοντας κόκαλα και λιπώδη μέρη.



Για πουλερικά, πρέπει να εισάγετε τον αισθητήρα πλαγίως, στη μέση του στήθους, φροντίζοντας η μύτη του αισθητήρα να μην καταλήξει σε κοίλο

μέρος. Σε περίπτωση κρέατος με πολύ ανομοιομορφο πάχος, ελέγξτε ότι έχει μαγειρευτεί σωστά πριν το αφαιρέσετε από το φούρνο. Συνδέστε το άκρο του αισθητήρα στην οπή που βρίσκεται στο δεξιό τοίχωμα του θαλάμου φούρνου. Όταν τοποθετηθεί ο αισθητήρας κρέατος στο φούρνο, ακούγεται ένα ηχητικό σήμα και



στην οθόνη εμφανίζεται το εικονίδιο και η θερμοκρασία στόχος.

Αν ο αισθητήρας κρέατος τοποθετηθεί κατά τη διάρκεια επιλογής μιας λειτουργίας, η οθόνη αλλάζει στην προεπιλεγμένη στοχευόμενη θερμοκρασία του αισθητήρα κρέατος.





Πιέστε  για έναρξη των ρυθμίσεων. Στρέψτε τον επιλογέα για να ρυθμίσετε τον αισθητήρα κρέατος στη στοχευόμενη θερμοκρασία. Πιέστε  για επιβεβαίωση. Στρέψτε το κουμπί για να επιλέξετε τη θερμοκρασία φούρνου.



Πιέστε  ή  για επιβεβαίωση και για να ξεκινήσει ο κύκλος μαγειρέματος.

Κατά τη διάρκεια του κύκλου μαγειρέματος, στην οθόνη εμφανίζεται η στοχευόμενη θερμοκρασία του αισθητήρα κρέατος. Όταν το κρέας φτάνει την επιλεγμένη στοχευόμενη θερμοκρασία, ο κύκλος μαγειρέματος σταματάει και στην οθόνη εμφανίζεται η ένδειξη "End" (Τέλος).

Για επανέναρξη του κύκλου μαγειρέματος, από το "End", στρέφοντας τον επιλογέα μπορείτε να ρυθμίσετε τη στοχευόμενη θερμοκρασία του αισθητήρα κρέατος με τον τρόπο που υποδεικνύεται πιο πάνω. Πατήστε  ή  για επιβεβαίωση και για επανέναρξη του κύκλου μαγειρέματος.

Σημείωση: κατά τη διάρκεια του κύκλου μαγειρέματος με τον αισθητήρα κρέατος, μπορείτε να στρέψετε τον επιλογέα για να αλλάξετε τη στοχευόμενη θερμοκρασία του αισθητήρα κρέατος. Πιέστε  για να ρυθμίσετε τη θερμοκρασία του φούρνου.

Ο αισθητήρας κρέατος μπορεί να τοποθετηθεί οποιαδήποτε στιγμή, ακόμα και κατά τη διάρκεια του κύκλου μαγειρέματος. Σε αυτήν την περίπτωση, πρέπει να επαναρυθμίσετε τις παραμέτρους της λειτουργίας μαγειρέματος.

Αν ο αισθητήρας κρέατος δεν είναι συμβατός με αυτή τη λειτουργία, ο φούρνος απενεργοποιεί (off) τον κύκλο μαγειρέματος και εκπέμπει ένα προειδοποιητικό ηχητικό σήμα. Σε αυτήν την περίπτωση, αποσυνδέστε τον αισθητήρα κρέατος ή πιέστε  για να επιλέξετε μια άλλη λειτουργία. Οι φάσεις έναρξης καθυστέρησης και προθέρμανσης δεν είναι συμβατές με τον αισθητήρα κρέατος.

. ΚΛΕΙΔΩΜΑ ΠΛΗΚΤΡΩΝ

Για να κλειδώσετε το πληκτρολόγιο, κρατήστε πατημένο το  για τουλάχιστον 5 δευτερόλεπτα.



Επαναλάβετε για να ξεκλειδώσετε το πληκτρολόγιο.

Σημείωση: Το κλειδί του πληκτρολογίου μπορεί να ενεργοποιηθεί και όταν το ψήσιμο βρίσκεται σε εξέλιξη. Για λόγους ασφάλειας, μπορεί να σβήσει οποιαδήποτε στιγμή πατώντας το κουμπί .

ΧΡΗΣΙΜΕΣ ΣΥΜΒΟΥΛΕΣ

ΤΡΟΠΟΣ ΑΝΑΓΝΩΣΗΣ ΤΟΥ ΠΙΝΑΚΑ ΜΑΓΕΙΡΕΜΑΤΟΣ

Στον πίνακα αναφέρεται η καλύτερη λειτουργία, εξαρτήματα και επίπεδο που πρέπει να χρησιμοποιηθούν για τους διαφορετικούς τύπους φαγητού. Η διάρκεια ψησίματος ξεκινά από τη στιγμή που τοποθετείται το φαγητό στο φούρνο, χωρίς να περιλαμβάνεται η προθέρμανση (εάν χρειάζεται). Οι θερμοκρασίες και οι χρόνοι ψησίματος είναι ενδεικτικά και εξαρτώνται από την ποσότητα του φαγητού και τον τύπο του εξαρτήματος που χρησιμοποιείται. Χρησιμοποιήστε αρχικά τις ελάχιστες συνιστώμενες τιμές και, εάν το φαγητό δεν έχει μαγειρευτεί αρκετά, προχωρήστε σε μεγαλύτερες τιμές. Χρησιμοποιήστε τα αξεσουάρ που παρέχονται και κατά προτίμηση σκουρόχρωμες μεταλλικές φόρμες γλυκού και ταψιά γενικής χρήσης. Μπορείτε επίσης να χρησιμοποιήσετε σκεύη και αξεσουάρ από πιρέξ ή στεατίτη, ωστόσο πρέπει να λάβετε υπόψη ότι ο χρόνος μαγειρέματος θα είναι λίγο μεγαλύτερος.

ΤΑΥΤΟΧΡΟΝΟ ΨΗΣΙΜΟ ΔΙΑΦΟΡΕΤΙΚΩΝ ΦΑΓΗΤΩΝ

Χρησιμοποιώντας τη λειτουργία "Εξαναγκ. αέρας", μπορείτε να μαγειρέψετε ταυτόχρονα διαφορετικά φαγητά τα οποία χρειάζονται την ίδια θερμοκρασία ψησίματος (για παράδειγμα: ψάρι και λαχανικά), χρησιμοποιώντας διαφορετικά ράφια. Αφαιρέστε το φαγητό που απαιτεί μικρότερο χρόνο μαγειρέματος και αφήστε στο φούρνο το φαγητό που απαιτεί το μεγαλύτερο χρόνο μαγειρέματος.

ΚΡΕΑΣ

Χρησιμοποιήστε οποιονδήποτε τύπο ταψιού φούρνου ή πιρέξ που είναι κατάλληλος για το κομμάτι κρέατος που θα μαγειρέψετε. Για ψητά, είναι καλό να προσθέσετε ζωμό στον πάτο του σκεύους και να περιχύνετε το κρέας στη διάρκεια του ψησίματος για καλύτερη γεύση. Λάβετε υπόψη ότι κατά τη διάρκεια αυτής της λειτουργίας θα παραχθεί ατμός. Όταν το ψητό είναι έτοιμο, αφήστε μέσα στο φούρνο για άλλα 10-15 λεπτά, ή τυλίξτε το σε αλουμινόχαρτο.

Όταν θέλετε να ψήσετε κρέας στο γκριλ, επιλέξτε κομμάτια με ομοιόμορφο πάχος για ομοιόμορφα αποτελέσματα. Τα πολύ παχιά κομμάτια κρέατος χρειάζονται περισσότερο χρόνο ψησίματος. Για να μην καεί το κρέας εξωτερικά, χαμηλώστε τη σχάρα και διατηρήστε το φαγητό πιο μακριά από το γκριλ. Γυρίστε το κρέας στα δύο τρίτα του συνολικού χρόνου ψησίματος. Ανοίξτε προσεκτικά την πόρτα δεδομένου ότι θα βγει ζεστός ατμός.

Για να συλλέξετε τους χυμούς κατά το ψήσιμο, συνιστάται να τοποθετήσετε ένα λιποσυλλέκτη με μισό λίτρο πόσιμου νερού ακριβώς κάτω από τη σχάρα όπου βρίσκεται το φαγητό. Συμπληρώστε νερό όταν χρειαστεί.

ΕΠΙΔΟΡΠΙΑ

Μαγειρέψτε γλυκά που απαιτούν δεξιοτεχνία με τη συμβατική λειτουργία μόνο σε ένα ράφι.

Χρησιμοποιήστε σκουρόχρωμες μεταλλικές φόρμες γλυκού και τοποθετείτε τις πάντα στην παρεχόμενη σχάρα. Για να μαγειρέψετε σε περισσότερα από ένα ράφια, επιλέξτε τη λειτουργία εξαναγκασμένου αέρα και τοποθετήστε τις φόρμες γλυκού στα ράφια, γεγονός που θα βοηθήσει τη βέλτιστη κυκλοφορία του θερμού αέρα.

Για να δείτε εάν έχει ψηθεί ένα αφράτο κέικ, τοποθετήστε μια ξύλινη οδοντογλυφίδα στο κέντρο του. Εάν η οδοντογλυφίδα βγει καθαρή, το κέικ είναι έτοιμο.

Εάν χρησιμοποιείτε αντικολητικές φόρμες, μη βουτυρώνετε τις άκρες καθώς το κέικ μπορεί να μη φουσκώσει ομοιόμορφα στις άκρες του.

Αν "φουσκώσει" κατά τη διάρκεια του ψησίματος, χρησιμοποιήστε χαμηλότερη θερμοκρασία την επόμενη φορά και ενδεχομένως μειώστε το υγρό που προσθέσατε ή ανακατέψτε το μείγμα πιο απαλά. Για γλυκά με υγρή γέμιση ή γαρνιτούρα (τσιζ κέικ ή φρουτόπιτες) χρησιμοποιήστε τη λειτουργία "Συμβ. ψήσιμο". Εάν η βάση του κέικ είναι υγρή, χαμηλώστε το ράφι και σκορπίστε ψίχουλα ψωμιού ή μπισκότων στη βάση του κέικ πριν προσθέσετε τη γέμιση.

















































































ΠΙΤΣΑ

Λαδώστε λίγο τα ταψιά για να έχει τραγανή βάση η πίτσα. Απλώστε τη μοτσαρέλα πάνω στην πίτσα όταν έχουν περάσει τα δύο τρίτα του χρόνου ψησίματος.

ΦΟΥΣΚΩΜΑ

Είναι πάντα προτιμότερο να καλύπτετε τη ζύμη με ένα υγρό πανί πριν τη βάλετε στο φούρνο. Κατά αυτόν τον τρόπο, μειώνεται ο χρόνος φουσκώματος της ζύμης στο ένα τρίτο περίπου συγκριτικά με το φούσκωμα σε θερμοκρασία δωματίου (20-25 °C). Ο χρόνος φουσκώματος για ζύμη για πίτσα βάρους 1 κιλού είναι περίπου μία ώρα.

ΠΙΝΑΚΑΣ ΨΗΣΙΜΑΤΟΣ

ΣΥΝΤΑΓΗ	ΛΕΙΤΟΥΡΓΙΑ	ΠΡΟΘΕΡΜ.	ΘΕΡΜΟΚΡΑΣΙΑ (°C)	ΧΡΟΝΟΣ ΜΑΓΕΙΡ. (Min.)	ΕΠΙΠΕΔΟ ΚΑΙ ΕΞΑΡΤΗΜΑΤΑ
Κέικ με ζύμη που φουσκώνει/ αφράτα κέικ		-	170	30 - 50	2 
		Ναι	160	30 - 50	2 
		Ναι	160	30 - 50	4 1  
Γεμιστά κέικ (τσιζκέικ, στρούντελ, μηλόπιτα)		-	160 - 200	30 - 85	3 
		Ναι	160 - 200	35 - 90	4 1  
Μπισκότα / Μικρά κέικ		-	160 - 170	20 - 40	3 
		Ναι	150 - 160	20 - 40	3 
		Ναι	150 - 160	20 - 40	4 1  
Σουδάκια		-	180 - 200	30 - 40	3 
		Ναι	180 - 190	35 - 45	4 1  
		Ναι	180 - 190	35 - 45*	5 3 1   
Μαρέγκα		Ναι	90	110 - 150	3 
		Ναι	90	130 - 150	4 1  
		Ναι	90	140 - 160*	5 3 1   
Pizza (λεπτή, χοντρή, φοκάτσια)		-	220 - 250	20 - 40	2 
		Ναι	220 - 240	20 - 40	4 1  
		Ναι	220 - 240	25 - 50*	5 3 1   
Φρατζόλα ψωμί 0,5 κιλό		-	180 - 220	50 - 70	2 
Μικρό ψωμί		-	180 - 220	30 - 50	3 
Ψωμί		Ναι	180 - 220	30 - 60	4 1  
Κατεψυγμένη πίτσα		-	250	10 - 20	2 
		Ναι	250	10 - 20	4 1  
Αλμυρές πίτες (πίτα λαχανικών, κικ)		Ναι	180 - 190	45 - 60	2 
		Ναι	180 - 190	45 - 60	4 1  
		Ναι	180 - 190	45 - 70*	5 3 1   
Βολοβάν/αλμυρά κράκερ με φύλλο κρούστας		Ναι	190 - 200	20 - 30	3 
		Ναι	180 - 190	20 - 40	4 1  
		Ναι	180 - 190	20 - 40*	5 3 1   
Λαζάνια/Φλαν		-	190 - 200	40 - 65	3 
Ζυμαρικά ψημένα/Κανελόνια		-	190 - 200	25 - 45	3 

ΣΥΝΤΑΓΗ	ΛΕΙΤΟΥΡΓΙΑ	ΠΡΟΘΕΡΜ.	ΘΕΡΜΟΚΡΑΣΙΑ (°C)	ΧΡΟΝΟΣ ΜΑΓΕΙΡ. (Min.)	ΕΠΙΠΕΔΟ ΚΑΙ ΕΞΑΡΤΗΜΑΤΑ
Αρνί/Μοσχάρι/Βοδινό/Χοιρινό 1 κιλό		-	190 - 200	60 - 90	3
Ψητό χοιρινό με κρούστα 2 κιλά		-	170	110 - 150	2
Κοτόπουλο / κουνέλι / πάπια 1 κιλό		-	200 - 230	50 - 80 **	3
Γαλοπούλα / Χήνα 3 κιλά		-	190 - 200	90 - 150	2
Ψάρι στο φούρνο/σε λαδόκολλα (φιλέτο, ολόκληρο)		Ναι	180 - 200	40 - 60	3
Γεμιστά λαχαν. (τομάτες, κολοκυθάκια, μελιτζάνες)		Ναι	180 - 200	50 - 60	2
Φρυγανισμένο ψωμί		-	3 (υψηλή)	3 - 6	5
Ψάρι φιλέτο/μπριζόλες		-	2 (μεσαία)	20 - 30***	4 3
Λουκάνικα / σουβλάκια-κεμπάμπ / παϊδάκια / μπιφτέκια χάμπουργκερ		-	2- 3 (μεσαία-υψηλή)	15 - 30***	5 4
Ψητό κοτόπουλο 1-1,3 κιλά		-	2 (μεσαία)	55 - 70**	2 1
Ροζμπίφ ωμό 1 κιλό		-	2 (μεσαία)	35 - 50**	3
Μπούτι αρνίσιο/Κότσι		-	2 (μεσαία)	60 - 90**	3
Ψητές πατάτες		-	2 (μεσαία)	35 - 55**	3
Λαχ. γκρατέν		-	3 (υψηλή)	10 - 25	3
Πλήρες γεύμα: τάρτα φρούτων (επίπεδο 5)/ λαζάνια (επίπεδο 3)/ κρέας (επίπεδο 1)		Ναι	190	40 - 120*	5 3 1
Λαζάνια και κρέας		Ναι	200	50 - 120*	4 1
Κρέας και πατάτες		Ναι	200	45 - 120*	4 1
Ψάρι και λαχανικά		Ναι	180	30 - 50	4 1
Γεμιστά κομμάτια ψητά		-	200	80 - 120*	3
Κομμάτια κρέατος (κουνέλι, κοτόπουλο, αρνί)		-	200	50 - 120*	3

* Εκτιμώμενη χρονική διάρκεια: Μπορείτε να αφαιρείτε το φαγητό από το φούρνο σε διαφορετικούς χρόνους, ανάλογα με την προσωπική προτίμηση.

** Γυρίστε το φαγητό στα δύο τρίτα του συνολικού χρόνου ψησίματος (αν είναι απαραίτητο).

*** Γυρίστε το φαγητό στο μέσο του συνολικού χρόνου ψησίματος

Σημείωση: Η λειτουργία 6th Sense "Γλυκά" χρησιμοποιεί μόνο την άνω και την κάτω αντίσταση, χωρίς τη εξαναγκασμένη κυκλοφορία αέρα. Δεν απαιτείται προθέρμανση.

ΛΕΙΤΟΥΡΓΙΕΣ	Συμβατικό	Γκριλ	Γκριλ τούρμπο	Εξαναγκ. αέρας	Συμβ. ψήσιμο	Εξαν. αέρας Eco
ΑΥΤΟΜΑΤΕΣ ΛΕΙΤΟΥΡΓΙΕΣ	Της κατασρόλας	Κρέας	Μαγείρεμα Maxi	Ψωμί	Πίτσα	Γλυκά κέικ
ΕΞΑΡΤΗΜΑΤΑ	Σχάρα	Ταψί γενικής χρήσης επάνω σε σχάρα	Λιποσυλλέκτης/ταψί ψησίματος ή ταψί γενικής χρήσης επάνω σε συρμάτινη σχάρα	Λιποσυλλέκτης / Ταψί ψησίματος	Λιποσυλλέκτης με 500 ml νερό	

ΣΥΝΤΗΡΗΣΗ ΚΑΙ ΚΑΘΑΡΙΣΜΟΣ

Βεβαιωθείτε ότι η συσκευή έχει κρυώσει πριν προχωρήσετε σε συντήρηση ή καθαρισμό.

Μη χρησιμοποιείτε ατμοκαθαριστές.

Μην χρησιμοποιείτε μεταλλικά σφουγγαράκια, λειαντικά συρματάκια ή λειαντικά/διαβρωτικά καθαριστικά, καθώς μπορεί να καταστρέψουν τις επιφάνειες της συσκευής.

Φοράτε προστατευτικά γάντια.

Η συσκευή πρέπει να αποσυνδεθεί από την παροχή ρεύματος πριν από οποιαδήποτε εργασία συντήρησης.

ΕΞΩΤΕΡΙΚΕΣ ΕΠΙΦΑΝΕΙΕΣ

- Καθαρίστε τις επιφάνειες με ένα υγρό πανί από μικροΐνες. Εάν υπάρχουν πολλές ακαθαρσίες, προσθέστε στο νερό λίγες σταγόνες απορρυπαντικού με ουδέτερο pH. Σκουπίστε με ένα στεγνό πανί.
- Μη χρησιμοποιείτε διαβρωτικά ή λειαντικά καθαριστικά. Εάν κάποιο από αυτά τα προϊόντα έρθει κατά λάθος σε επαφή με τις επιφάνειες της συσκευής, καθαρίστε το αμέσως με ένα υγρό πανί με μικροΐνες.

ΕΣΩΤΕΡΙΚΕΣ ΕΠΙΦΑΝΕΙΕΣ

- Μετά από κάθε χρήση, αφήστε το φούρνο να κρυώσει και μετά καθαρίστε τον, κατά προτίμηση ενώ είναι ακόμα ζεστός, για να αφαιρέσετε τα υπολείμματα ή τους λεκέδες από τα τρόφιμα. Για να στεγνώσει τυχόν υγρασία που δημιουργήθηκε λόγω ψησίματος φαγητού με υψηλή περιεκτικότητα σε νερό, αφήστε το φούρνο να κρυώσει εντελώς και στη συνέχεια καθαρίστε τον με ένα ύφασμα ή ένα σφουγγάρι.

- Καθαρίζετε το κρύσταλλο της πόρτας με ειδικό υγρό απορρυπαντικό.
- Ενεργοποιήστε τη λειτουργία "Smart Clean" για τέλειο καθαρισμό των εσωτερικών επιφανειών.
- Για να διευκολύνετε τον καθαρισμό του φούρνου, μπορείτε να βγάλετε την πόρτα.
- Η επάνω αντίσταση του γκριλ μπορεί να κατεβεί για να καθαριστεί η άνω επιφάνεια του φούρνου.

ΑΞΕΣΟΥΡΑ

Αφήστε τα να μουλιάσουν σε νερό με απορρυπαντικό μετά τη χρήση. Χρησιμοποιήστε γάντια φούρνου για το χειρισμό τους, εάν είναι ακόμη ζεστά. Τα υπολείμματα φαγητών μπορούν να αφαιρεθούν εύκολα με κατάλληλη βούρτσα ή σφουγγαράκι.

ΚΑΘΑΡΙΣΜΟΣ ΚΑΤΑΛΥΤΙΚΩΝ ΚΑΠΑΚΙΩΝ

(ΜΟΝΟ ΣΕ ΟΡΙΣΜΕΝΑ ΜΟΝΤΕΛΑ)

Ο φούρνος εξοπλίζεται με ειδικά καταλυτικά καπάκια που διευκολύνουν τον καθαρισμό του θαλάμου μαγειρέματος χάρη στην ειδική αυτοκαθαριζόμενη επίστρωση, η οποία είναι εξαιρετικά πορώδης και είναι σε θέση να απορροφήσει τα λίπη και τη βρωμιά.

Αυτά τα καπάκια εφαρμόζονται στους οδηγούς ραφιών: Όταν επανατοποθετείτε και επαναπροσαρμόζετε τους οδηγούς ραφιών, να βεβαιώνετε ότι οι γάντζοι στην κορυφή είναι τοποθετημένοι στις κατάλληλες οπές στα καπάκια.

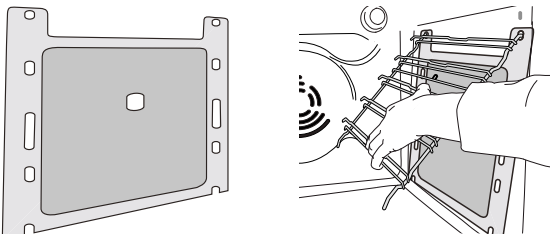

Για την καλύτερη χρήση των ιδιοτήτων αυτοκαθαρισμού των καπακιών, σας προτείνουμε να ζεστάνετε το φούρνο στους 200 °C για περίπου μία ώρα χρησιμοποιώντας τη λειτουργία "Συμβ. Ψήσιμο". Ο φούρνος κατά τη διάρκεια αυτής της λειτουργίας πρέπει να είναι άδειος.

Στη συνέχεια αφήστε τη συσκευή να κρυώσει πριν καθαρίσετε τα υπολείμματα τροφών με ένα μη διαβρωτικό σφουγγαράκι.

Σημείωση: Η χρήση διαβρωτικών ή αποξεστικών ουσιών, χοντρές βούρτσες, ξύστρες για πουρί ή σπρέι φούρνου που μπορούν να προκαλέσουν ζημιά στην καταλυτική επιφάνεια και να καταστρέψουν τις ιδιότητες αυτόματου καθαρισμού της.

Αν απαιτείται αντικατάσταση των καπακιών, επικοινωνήστε με το Κέντρο Εξυπηρέτησης Πελατών.

ΑΝΤΙΚΑΤΑΣΤΑΣΗ ΤΟΥ ΦΩΤΟΣ

1. Αποσυνδέστε το φούρνο από την ηλεκτρική τροφοδοσία.
2. Ξεβιδώστε το καπάκι από το φως, αντικαταστήστε το λαμπτήρα και βιδώστε ξανά το καπάκι.
3. Συνδέστε ξανά το φούρνο στην ηλεκτρική τροφοδοσία.

Σημείωση: Να χρησιμοποιείτε μόνο λαμπτήρες αλογόνου 20-40W/230 ~ V τύπου G9, T300 °C. Ο λαμπτήρας που χρησιμοποιείται στη συσκευή είναι ειδικά σχεδιασμένος για οικιακές συσκευές και δεν είναι κατάλληλος για το γενικό φωτισμό δωματίου μέσα στο σπίτι (Κανονισμός ΕΚ αριθ. 244/2009). Μπορείτε να προμηθευτείτε τους λαμπτήρες από το Κέντρο Τεχνικής Υποστήριξης.

- Αν χρησιμοποιείτε λαμπτήρες αλογόνου, μη χειρίζεστε τους λαμπτήρες με γυμνά χέρια καθώς τα αποτυπώματα μπορεί να τους καταστρέψουν. Μη χρησιμοποιήσετε το φούρνο πριν τοποθετήσετε ξανά το καπάκι του λαμπτήρα. Αυτό το προϊόν περιέχει μια φωτεινή πηγή ενεργειακής κλάσης G.

ΧΑΜΗΛΩΣΤΕ ΤΗΝ ΑΝΩ ΑΝΤΙΣΤΑΣΗ (ΜΟΝΟ ΣΕ ΟΡΙΣΜΕΝΑ ΜΟΝΤΕΛΑ)

1. Αφαιρέστε τους πλαϊνούς οδηγούς του ραφιού.

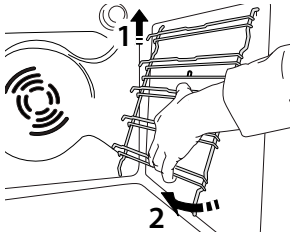

2. Τραβήξτε την αντίσταση ελαφρώς λίγο προς τα έξω και χαμηλώστε την.

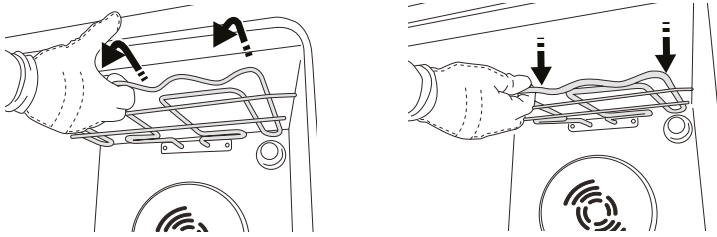

3. Για να επαναφέρετε την αντίσταση στη θέση της, ανασηκώστε την τραβώντας την ελαφρώς προς τη μεριά σας και βεβαιωθείτε ότι κάθεται πάνω στα πλευρικά στηρίγματα.

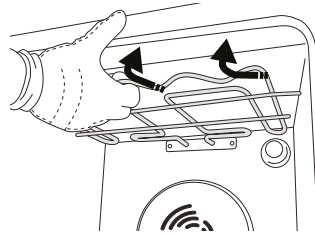

ΑΦΑΙΡΕΣΗ ΚΑΙ ΕΠΑΝΑΤΟΠΟΘΕΤΗΣΗ ΠΟΡΤΑΣ

1. Για να αφαιρέσετε την πόρτα, ανοίξτε εντελώς και κατεβάστε τα άγκιστρα έως ότου φτάσουν σε θέση απασφάλισης.

2. Κλείστε την πόρτα όσο περισσότερο μπορείτε. Πιάστε καλά την πόρτα και με τα δύο χέρια – μην την κρατάτε από τη χειρολαβή.

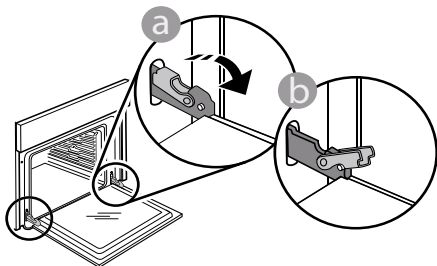

Απλά αφαιρέστε την πόρτα ενώ την κλείνετε τραβώντας προς τα επάνω ταυτόχρονα έως ότου βγει από την έδρα της. Ακουμπήστε την πόρτα στη μία πλευρά, πάνω σε μια μαλακή επιφάνεια.

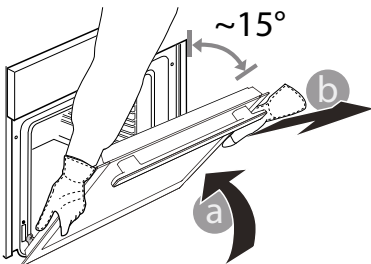

3. Επανατοποθετήστε την πόρτα μετακινώντας την προς την πλευρά του φούρνου, ευθυγραμμίζοντας τους γάντζους των μεντεσέδων με τις έδρες τους και ασφαλίζοντας την επάνω πλευρά στην έδρα του κάθε μεντεσέ.

4. Χαμηλώστε την πόρτα και στη συνέχεια ανοίξτε την εντελώς.

Χαμηλώστε τα άγκιστρα στην αρχική τους θέση: Βεβαιωθείτε ότι τα κατεβάσατε εντελώς κάτω.

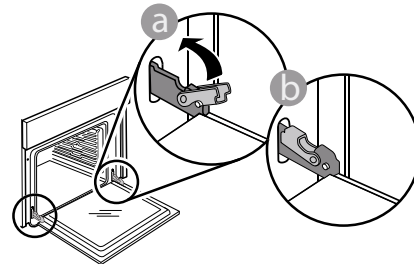

Ασκήστε ελαφριά πίεση για να βεβαιωθείτε ότι τα άγκιστρα βρίσκονται στη σωστή θέση.

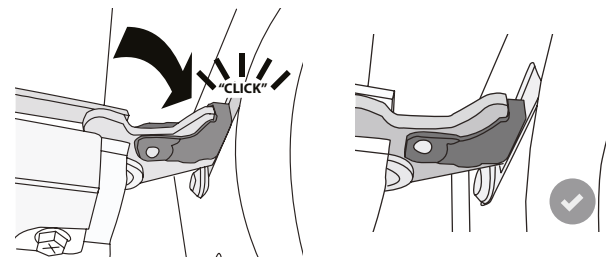

5. Δοκιμάστε να κλείσετε την πόρτα και βεβαιωθείτε ότι είναι ευθυγραμμισμένη με τον πίνακα ελέγχου.

Διαφορετικά, επαναλάβετε τα παραπάνω βήματα: Αν δεν λειτουργεί κανονικά μπορεί να προκληθεί ζημιά στην πόρτα.

ΑΝΤΙΜΕΤΩΠΙΣΗ ΠΡΟΒΛΗΜΑΤΩΝ

Πρόβλημα	Πιθανή αιτία	Λύση
Ο φούρνος δεν λειτουργεί.	Διακοπή ρεύματος. Αποσύνδεση από την παροχή ρεύματος.	Βεβαιωθείτε ότι ο φούρνος τροφοδοτείται με ρεύμα και ότι είναι σωστά συνδεδεμένος στην πρίζα. Σβήστε και ανάψτε ξανά το φούρνο για να διαπιστώσετε εάν η βλάβη παραμένει.
Στην οθόνη εμφανίζεται το γράμμα "F" ακολουθούμενο από έναν αριθμό ή ένα γράμμα.	Πρόβλημα λογισμικού.	Επικοινωνήστε με το πλησιέστερο Κέντρο Εξυπηρέτησης Πελατών και αναφέρετε τον αριθμό μετά το γράμμα "F".
Η οθόνη εμφανίζει ασαφές κείμενο και φαίνεται να είναι σπασμένη.	Άλλο σεντ γλώσσας.	Επικοινωνήστε με το πλησιέστερο Κέντρο Εξυπηρέτησης Πελατών.

ΔΕΛΤΙΟ ΠΡΟΪΟΝΤΟΣ

 Μπορείτε να κατεβάσετε το δελτίο προϊόντος με τα δεδομένα ενέργειας της συσκευής από την ιστοσελίδα **docs.whirlpool.eu**

ΠΩΣ ΘΑ ΛΑΒΕΤΕ ΤΟΝ ΟΔΗΓΟ ΧΡΗΣΗΣ ΚΑΙ ΣΥΝΤΗΡΗΣΗΣ

>  Κατεβάστε τον "Οδηγό χρήσης και φροντίδας" από την ιστοσελίδα μας **docs.whirlpool.eu** (μπορείτε να χρησιμοποιήσετε αυτόν τον κωδικό QR), αναφέροντας τον εμπορικό κωδικό προϊόντος.



> Εναλλακτικά, επικοινωνήστε με το κέντρο εξυπηρέτησης πελατών

ΕΠΙΚΟΙΝΩΝΙΑ ΜΕ ΤΟ ΚΕΝΤΡΟ ΕΞΥΠΗΡΕΤΗΣΗΣ ΠΕΛΑΤΩΝ

Μπορείτε να βρείτε τις πληροφορίες επικοινωνίας στο εγχειρίδιο εγγύησης. Όταν επικοινωνείτε με το κέντρο εξυπηρέτησης πελατών, να αναφέρετε τους κωδικούς που αναγράφονται στην πινακίδα του προϊόντος σας.

