

PHPN9.5FLMX/1

12NC: F165219

GTIN (EAN) code: 5054645652198

Hotpoint

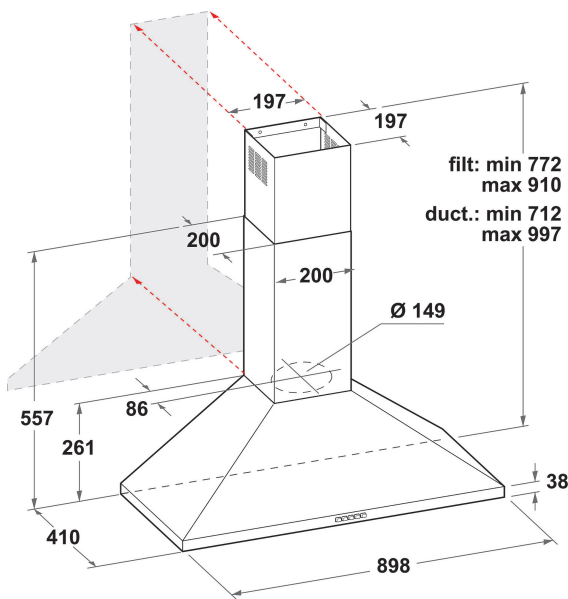

MAIN FEATURES

Product group	Hood
Colour body	Inox
Material body	Stainless steel
Colour chimney	Inox
Material chimney	Stainless steel
Typology	Wall-mounted
Installation type	Wall-mounted
Type of control	Mechanical
Type of control settings	-
Decor panel options	N/A
Motor location	Integrated motor in hood body
Operating Mode	Convertible
Electrical connection rating (W)	145
Current (A)	0,6
Voltage (V)	220-240
Frequency (Hz)	50/60
Length of Electrical Supply Cord (cm)	205
Plug type	No
Chimney height (mm)	-
Height of product, without chimney (mm)	261
Height of the product	997
Width of the product	898
Depth of the product	411
Minimum niche height	0
Minimum niche width	0
Niche depth	0
Net weight (kg)	8.3

TECHNICAL FEATURES

Type of manual control devices	Buttons
Type of automatic control devices	-
Number of motors	1
Total power of the motors (W)	140
Number of speed settings: boost option availability	3
Boost presence	No
Maximum output air extraction (m ³ /h)	435
Boost position air extraction (m ³ /h)	0
Maximum output recirculating air (m ³ /h)	315
Boost position output recirculating (m ³ /h)	0
Light Control Type	On/Off
Number of lights	2
Type of lamps used	LED
Total power of the lamps (W)	5
Diameter of air outlet (mm)	150
No-return airflow flap	Yes
Grease filter material	Washable aluminium
Odour filter	Yes

PERFORMANCES

Sound power at min. speed (2010/30/EU)	56
Sound power at max. speed (2010/30/EU)	65
Noise level with boost position (dB(A) re 1 pW)	62