



THANK YOU FOR BUYING A WHIRLPOOL PRODUCT
In order to receive a more complete assistance, please register your product on www.whirlpool.eu/register



Before using the appliance carefully read the Safety Instruction.

PRODUCT DESCRIPTION

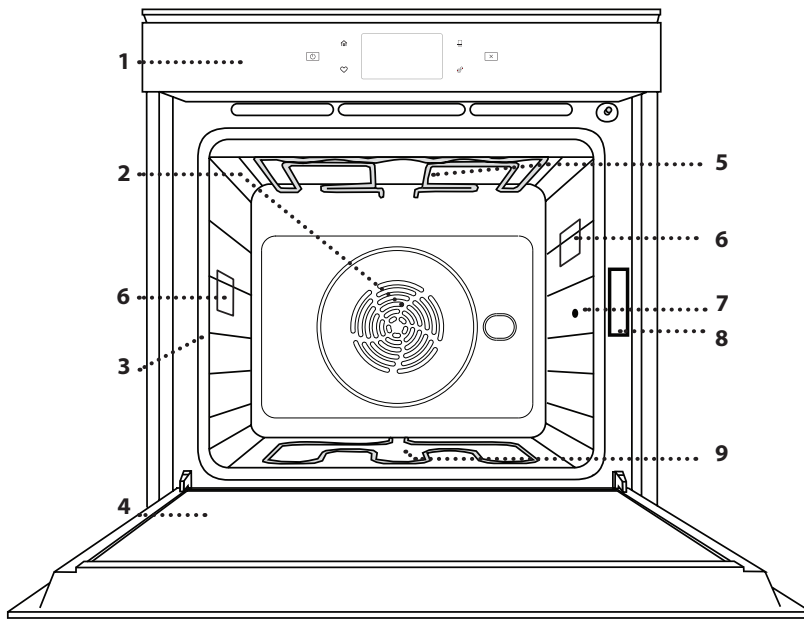

1. Control panel
2. Fan and circular heating element
(not visible)
3. Shelf guides
(the level is indicated on the front of the oven)
4. Door
5. Upper heating element/grill
6. Lamp
7. Food probe insert point
8. Identification plate
(do not remove)
9. Lower heating element
(not visible)

CONTROL PANEL DESCRIPTION

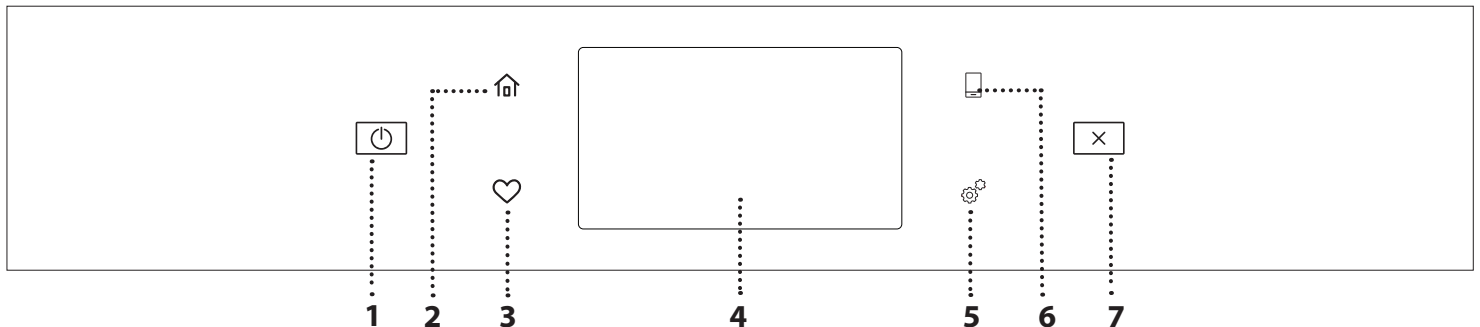

1. ON / OFF

For switching the oven on and off.

2. HOME

For gaining quick access to the main menu.

3. FAVORITE

For retrieving up the list of your favorite functions.

4. DISPLAY

5. TOOLS

To choose from several options and also change the oven settings and preferences.

6. REMOTE CONTROL

To enable use of the 6th Sense Live Whirlpool app.

7. CANCEL

To stop any oven function except the Clock, Kitchen Timer and Control Lock.

ACCESSORIES

WIRE SHELF

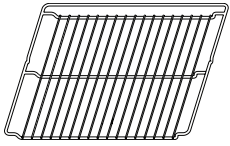

Use to cook food or as a support for pans, cake tins and other ovenproof items of cookware

DRIP TRAY

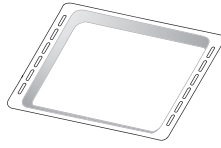

Use as an oven tray for cooking meat, fish, vegetables, focaccia, etc. or position underneath the wire shelf to collect cooking juices.

BAKING TRAY

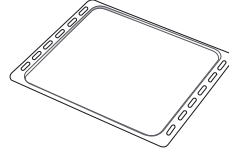

Use for cooking all bread and pastry products, but also for roasts, fish en papillote, etc.

SLIDING RUNNERS *

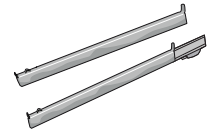

To facilitate inserting or removing accessories.

FOOD PROBE

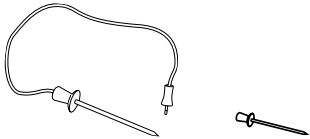

To accurately measure the core temperature of food during cooking. Thanks to its four sensing points and rigid support, it can be used for meat and fish, and also for bread, cakes and baked pastries.

* Available only on certain models

The number and the type of accessories may vary depending on which model is purchased.

Other accessories can be purchased separately from the After-sales Service.

INSERTING THE WIRE SHELF AND OTHER ACCESSORIES

Insert the wire shelf horizontally by sliding it across the shelf guides, making sure that the side with the raised edge is facing upwards.

Other accessories, such as the drip tray and the baking tray, are inserted horizontally in the same way as the wire shelf.

REMOVING AND REFITTING THE SHELF GUIDES

- To remove the shelf guides, lift the guides up and then gently pull the lower part out of its seating: The shelf guides can now be removed.
- To refit the shelf guides, first fit them back into their upper seating. Keeping them held up, slide them into the cooking compartment, then lower them into position in the lower seating.

FITTING THE SLIDING RUNNERS (IF PRESENT)

Remove the shelf guides from the oven and remove the protective plastic from the sliding runners.

Fasten the upper clip of the runner to the shelf guide and slide it along as far as it will go. Lower the other clip into position. To secure the guide, press the lower portion of the clip firmly against the shelf guide. Make sure that the runners can move freely. Repeat these steps on the other shelf guide on the same level.

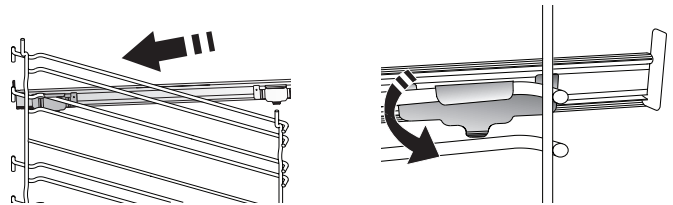

Please note: The sliding runners can be fitted on any level.

COOKING FUNCTIONS



MANUAL FUNCTIONS

- **FAST PREHEAT**
For preheating the oven quickly.
- **CONVENTIONAL**
For cooking any kind of dish on one shelf only.
- **GRILL**
For grilling steaks, kebabs and sausages, cooking vegetables au gratin or toasting bread. When grilling meat, we recommend using a drip tray to collect the cooking juices: Position the tray on any of the levels below the wire shelf and add 500 ml of drinking water.
- **TURBO GRILL**
For roasting large joints of meat (legs, roast beef, chicken). We recommend using a drip tray to collect the cooking juices: Position the pan on any of the levels below the wire shelf and add 500 ml of drinking water.
- **FORCED AIR**
For cooking different foods that require the same cooking temperature on several shelves (maximum three) at the same time. This function can be used to cook different foods without odours being transferred from one food to another.
- **COOK 4 FUNCTIONS**
For cooking different foods that require the same cooking temperature on four levels at the same time. This function can be used to cook cookies, tarts, round pizzas (also frozen) and to prepare a complete meal. Follow the cooking table to obtain the best results.
- **CONVECTION BAKE**
For cooking meat, baking cakes with fillings on one shelf only.
- **SPECIAL FUNCTIONS**
 - » **DEFROST**
To speed up defrosting of food. Place food on the middle shelf. Leave food in its packaging to prevent it from drying out on the outside.
 - » **KEEP WARM**
For keeping just-cooked food hot and crisp.
 - » **RISING**
For optimal proving of sweet or savoury dough. To maintain the quality of proving, do not activate the function if the oven is still hot following a cooking cycle.

» CONVENIENCE

To cook ready-made food, stored at room temperature or in the refrigerator (biscuits, cake mix, muffins, pasta dishes and bread-type products). The function cooks all the dishes quickly and gently and can also be used to heat food already cooked. The oven does not need to be pre-heated. Follow the instructions on the packaging.

» MAXI COOKING

To cook large joints of meat (above 2.5 kg). It is advisable to turn the meat over during cooking, to obtain even browning on both sides. It is best to baste the meat every now and again to prevent it from drying out.

» ECO FORCED AIR

For cooking stuffed roasting joints and fillets of meat on a single shelf. Food is prevented from drying out excessively by gentle, intermittent air circulation. When this ECO function is in use, the light will remain switched off during cooking. To use the ECO cycle and therefore optimise power consumption, the oven door should not be opened until the food is completely cooked.

• FROZEN BAKE

The function automatically selects the ideal cooking temperature and mode for 5 different types of ready frozen food. The oven does not have to be preheated.



6th SENSE

These enable all types of food to be cooked fully automatically. To use at best this function, follow the indications on the relative cooking table. The oven does not have to be preheated.

HOW TO USE THE TOUCH DISPLAY



To scroll through a menu or a list:

Simply swipe your finger across the display to scroll through the items or values.



To select or confirm:

Tap the screen to select the value or menu item you require.

To go back to the previous screen:

Tap < .

To confirm settings or access the next screen:

Tap "SET" or "NEXT".

FIRST TIME USE

You will need to configure the product when you switch on the appliance for the first time.

The settings can be changed subsequently by pressing  to access the "Tools" menu.

1. SELECT THE LANGUAGE

You will need to set the language and the time when you switch on the appliance for the first time.

- Swipe across the screen to scroll through the list of available languages.
- Tap the language you require.

Tapping < will take you back to the previous screen.

2. SELECT SETTINGS MODE

Once you have selected the language, the display will prompt you to choose between "STORE DEMO" (useful for retailers, for display purposes only) or continue by tapping "NEXT".

3. SETTING UP WIFI

The 6th Sense Live feature allows you to operate the oven remotely from a mobile device. To enable the appliance to be controlled remotely, you will need to complete the connection process successfully first. This process is necessary to register your appliance and connect it to your home network.

- Tap "SETUP NOW" to proceed with setup connection.

Otherwise, tap "SKIP" to connect your product later.

HOW TO SET UP THE CONNECTION

To use this feature you will need: A smartphone or tablet and a wireless router connected to the Internet. Please use your smart device to check that your home wireless network's signal is strong close to the appliance.

Minimum requirements.

Smart device: Android with a 1280x720 (or higher) screen or iOS.

See on App store the app compatibility with Android or iOS versions.

Wireless router: 2.4Ghz WiFi b/g/n.

1. Download the 6th Sense Live app

The first step to connecting your appliance is to download the app on your mobile device. The 6th Sense Live app will guide you through all the steps listed here. You can download the 6th Sense Live app from the iTunes Store or the Google Play Store.

2. Create an account

If you haven't done so already, you'll need to create an account. This will enable you to network your appliances and also view and control them remotely.

3. Register your appliance

Follow the instructions in the app to register your appliance. You will need the Smart Appliance Identifier (SAID) number to complete the registration process. You can find its unique code on the identification plate attached to the product.

4. Connect to WiFi

Follow the scan-to-connect setup procedure. The app will guide you through the process of connecting your appliance to the wireless network in your home.

If your router supports WPS 2.0 (or higher), select "MANUALLY", then tap "WPS Setup": Press the WPS button on your wireless router to establish a connection between the two products.

If necessary, you can also connect the product manually using "Search for a network".

The SAID code is used to synchronise a smart device with your appliance.

The MAC address is displayed for the WiFi module.

The connection procedure will only need to be carried out again if you change your router settings (e.g. network name or password or data provider).

4. SETTING THE TIME AND DATE

Connecting the oven to your home network will set the time and date automatically. Otherwise you will need to set them manually.

- Tap the relevant numbers to set the time of the day.
- Tap "SET" to confirm.

Once you have set the time, you will need to set the date.

- Tap the relevant numbers to set the date.
- Tap "SET" to confirm.

5. SET THE POWER CONSUMPTION

The oven is programmed to consume a level of electrical power that is compatible with a domestic network that has a rating of more than 3 kW (16 Ampere): If your household uses a lower power, you will need to decrease this value (13 Ampere).

- Tap the value on the right to select the power.
- Tap "OKAY" to complete the initial setup.

6. HEAT THE OVEN

A new oven may release odours that have been left behind during manufacturing: this is completely normal.

Before starting to cook food, we therefore recommend heating the oven with it empty in order to remove any possible odours.

DAILY USE

1. SELECT A FUNCTION

- To switch on the oven, press  or touch anywhere on the screen.

The display allows you to choose between Manual and 6th Sense Functions.

- Tap the main function you require to access the corresponding menu.
- Scroll up or down to explore the list.
- Select the function you require by tapping it.

2. SET MANUAL FUNCTIONS

After having selected the function you require, you can change its settings. The display will show the settings that can be changed.

TEMPERATURE / GRILL LEVEL

- Scroll through the suggested values and select the one you require.

If allowed by the function, you can tap  to activate preheating.

DURATION

You do not have to set the cooking time if you want to manage cooking manually. In timed mode, the oven cooks for the length of time you select. At the end of the cooking time, the cooking is stopped automatically.

- To set the duration, tap "Set Cook Time".
- Tap the relevant numbers to set the cooking time you require.
- Tap "NEXT" to confirm.

To cancel a set duration during cooking and so manage manually the end of cooking, tap the duration value and then select "STOP".

3. SET 6th SENSE FUNCTIONS

The 6th Sense functions enable you to prepare a wide variety of dishes, choosing from those shown in the list. Most cooking settings are automatically selected by the appliance in order to achieve the best results.

- Choose a recipe from the list.

Functions are displayed by food categories in the "6th SENSE FOOD" menu (see relative tables) and by recipe features in the "LIFESTYLE" menu.

- Once you have selected a function, simply indicate the characteristic of the food (quantity, weight, etc.) you want to cook to achieve the perfect result.

Remove any protective cardboard or transparent film from the oven and remove any accessories from inside it.

Heat the oven to 200 °C for around one hour.

It is advisable to air the room after using the appliance for the first time.

Some of the 6th Sense functions require use of the food probe. Plug it in before selecting the function. For best results with the probe, follow the suggestions in the relevant section.

- Follow the on-screen prompts to guide you through the cooking process.

4. SET START / END TIME DELAY

You can delay cooking before starting a function: The function will start or end at the time you select in advance.

- Tap "DELAY" to set the start time or end time you require.
- Once you have set the required delay, tap "START DELAY" to start the waiting time.
- Place the food in the oven and close the door: The function will start automatically after the period of time that has been calculated.

Programming a delayed cooking start time will disable the oven preheating phase: The oven will reach the temperature you require gradually, meaning that cooking times will be slightly longer than those listed in the cooking table.

- To activate the function immediately and cancel the programmed delay time, tap .

5. START THE FUNCTION

- Once you have configured the settings, tap "START" to activate the function.

If the oven is hot and the function requires a specific maximum temperature, a message will shown on the display. You can change the values that have been set at any time during cooking by tapping the value you want to amend.

- Press  to stop the active function at any time.

6. PREHEATING

If previously activated, once the function has been started the display indicates the status of preheating phase.

Once this phase has been finished, an audible signal will sound and the display will indicate that the oven has reached the set temperature.

- Open the door.
- Place the food in the oven.
- Close the door and tap "DONE" to start cooking.

Placing the food in the oven before preheating has finished may have an adverse effect on the final cooking result. Opening the door during the preheating phase will pause it. The cooking time does not include a preheating phase.

7. PAUSING COOKING

Some 6th Sense functions will require to turn the food during cooking. An audible signal will sound and the displays shows the action must to be done.

- Open the door.
- Carry out the action prompted by the display.
- Close the door, then tap "DONE" to resume cooking.

Before cooking ends, the oven could prompt you to check the food in the same way.



An audible signal will sound and the displays shows the action must to be done.

- Check the food.
- Close the door, then tap "DONE" to resume cooking.

8. END OF COOKING

An audible signal will sound and the display will indicate that cooking is complete.

With some functions, once cooking has finished you can give your dish extra browning, extend the cooking time or save the function as a favorite.

- Tap  to save it as a favorite.
- Select "Extra Browning" to start a five-minute browning cycle.
- Tap  to prolong the cooking.

9. FAVORITES

The Favorites feature stores the oven settings for your favorite recipes.

The oven automatically detects the functions you use most often. After a certain number of uses, you will be prompted to add the function to your favorites.

HOW TO SAVE A FUNCTION

Once a function has finished, you can tap  to save it as favorite. This will enable you to use it quickly in the future, keeping the same settings.

The display allows you to save the function by indicating up to 4 favorite meal times, including breakfast, lunch, snack and dinner.

- Tap the icons to select at least one.
- Tap "SAVE AS FAVORITE" to save the function.

ONCE SAVED

Once you have saved functions as favorites, the main screen will display the functions you have saved for the current the time of day.

To view the favorites menu, press  : The functions will be divided by different meal times and some suggestions will be offered.

- Tap the meals icon to show the relevant lists.

Tapping  also enables you to view your history of most recently used functions.

- Scroll through the prompted list.
- Tap the recipe or function you require.
- Tap "START" to activate the cooking.

CHANGING THE SETTINGS



In the Favorites screen, you can add an image or name to each favorite to customise it to your preferences.

- Select the function you want to change.
- Tap "EDIT".
- Select the attribute you want to change.
- Tap "NEXT": The display will show the new attributes.
- Tap "SAVE" to confirm your changes.

In the Favorites screen, you can also delete functions you have saved:

- Tap the  on the relevant function.
- Tap "REMOVE IT".

You can also change the time when the various meals are shown:

- Press .
- Select  "Preferences".
- Select "Times and Dates".
- Tap "Your Meal Times".
- Scroll through the list and tap the relevant time.
- Tap the relevant meal to change it.

Each time slot can be combined with one meal only.

10. TOOLS

Press  to open the "Tools" menu at any time.

This menu enables you to choose from several options and also change the settings or preferences for your product or the display.

REMOTE ENABLE

To enable use of the 6th Sense Live Whirlpool app.

KITCHEN TIMER

This function can be activated either when using a cooking function or alone for keeping time.

Once started, the timer will count down independently without interfering with the function itself.

The timer will continue counting down at the top-right corner of the screen.

The timer will continue counting down, shown on top-right corner of the screen.

To retrieve or change the kitchen timer:

- Press .
- Tap .

An audible signal will sound and the display will indicate once the timer has finished counting down the selected time.

- Tap "DISMISS" to cancel the timer or set a new timer duration.
- Tap "SET NEW TIMER" to set the timer again.



LIGHT

To switch on or off the oven lamp.



SELF-CLEAN

Activate the "Self-Clean" function for optimum cleaning of the internal surfaces.

It is recommended to do not open the oven door during the cleaning cycle to avoid a loss of water vapor that could get an adverse effect on the final cleaning result.

- Remove all accessories from the oven before activating the function.
- When the oven is cold, pour 200 ml of drinking water on the bottom of the oven.
- Tap on "START" to activate the cleaning function.

Once the cycle has been selected, it is possible to delay the start of the automatic cleaning. Tap on "DELAY" to set the end time as indicated in the relative paragraph.



PROBE

Using the probe enables you to measure the core temperature of the meat during cooking to ensure that it reaches the optimum temperature. The temperature of the oven varies according to the function that you have selected, but cooking is always programmed to finish once the specified temperature has been reached.

Place food in the oven and connect the food probe to the socket. Keep the probe as far away from the heat source as possible. Close the oven door.

Tap . You can choose between the manual (by cooking method) and 6th Sense (by food type) functions if use of the probe is allowed or required.

Once a cooking function has been started, it will be cancelled if the probe is removed.

Always unplug and remove the probe from the oven when taking out the food.

USING THE FOOD PROBE

Place the food in the oven and connect the plug by inserting it into the connection provided on the righthand side of the oven's cooking compartment. The cable is semi-rigid and can be shaped as needed to insert the probe into the food in the most effective way. Make sure that the cable does not touch the top heating element during cooking.

MEAT: Insert the probe deep into the meat, avoiding bones or fatty areas. For poultry, insert the probe lengthways into the centre of the breast, avoiding hollow areas.

FISH (whole): Position the tip in the thickest part, avoiding the thorns.

OVEN BAKING: Insert the tip deep into the dough by shaping the cable to achieve the optimum probe angle. If you use the probe when cooking with the 6th Sense functions, cooking will be stopped automatically when the selected recipe reaches the ideal core temperature, without the need to set the oven temperature.

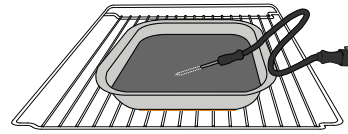

Lasagna

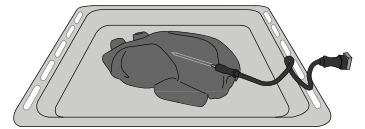

Whole Chicken

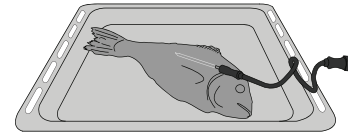

Fish

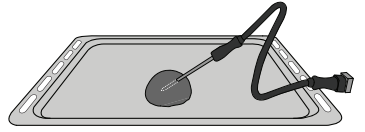

Rolls

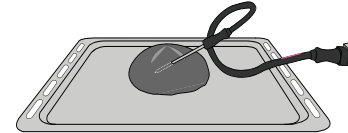

Big Bread

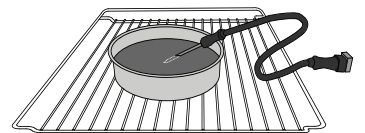

Cake



MUTE

Tap icon to mute or unmute all the sounds and alarms.



CONTROL LOCK

The "Control Lock" enables you to lock the buttons on the touch pad so they cannot be pressed accidentally.

To activate the lock:

- Tap the .

To deactivate the lock:



- Tap the display.
- Swipe up on the message shown.



MORE MODES

For selecting Sabbath mode and accessing Power Management.

Sabbath mode keeps the oven on in baking mode until disabled. Sabbath mode uses the conventional function. All other cooking and cleaning cycles are disabled. No tones will sound, and the displays will not indicate temperature changes. When the oven door is opened or closed, the oven light will not turn on or off, and the heating elements will not turn on or off immediately.

To disable and exit Sabbath mode, press  or , then press and hold the display screen for 3 seconds.



PREFERENCES

For changing several oven settings.



WIFI

For changing settings or configuring a new home network.



INFO

For switching off "Store Demo Mode", resetting the product and obtaining further information about the product.

COOKING TABLE

RECIPE	FUNCTION	PREHEAT	TEMPERATURE (°C)	DURATION (Min.)	SHELF AND ACCESSORIES
Leavened cakes / Sponge cakes		Yes	170	30 - 50	
		Yes	160	30 - 50	
		Yes	160	30 - 50	
Filled cakes (cheesecake, strudel, apple pie)		Yes	160 - 200	30 - 85	
		Yes	160 - 200	35 - 90	
Cookies / Shortbread		Yes	150	20 - 40	
		Yes	140	30 - 50	
		Yes	140	30 - 50	
		Yes	135	40 - 60	
Small cakes / Muffin		Yes	170	20 - 40	
		Yes	150	30 - 50	
		Yes	150	30 - 50	
		Yes	150	40 - 60	
Choux buns		Yes	180 - 200	30 - 40	
		Yes	180 - 190	35 - 45	
		Yes	180 - 190	35 - 45 *	
Meringues		Yes	90	110 - 150	
		Yes	90	130 - 150	
		Yes	90	140 - 160 *	
Pizza / Bread / Focaccia		Yes	190 - 250	15 - 50	
		Yes	190 - 230	20 - 50	
Pizza (Thin, thick, focaccia)		Yes	220 - 240	25 - 50 *	
Frozen pizza		Yes	250	10 - 15	
		Yes	250	10 - 20	
		Yes	220 - 240	15 - 30	
Savoury pies (vegetable pie, quiche)		Yes	180 - 190	45 - 55	
		Yes	180 - 190	45 - 60	
		Yes	180 - 190	45 - 70 *	
Vols-au-vent / Puff pastry crackers		Yes	190 - 200	20 - 30	
		Yes	180 - 190	20 - 40	
		Yes	180 - 190	20 - 40 *	

ACCESSORIES

Wire shelf

Oven tray or cake tin on wire shelf

Drip tray / Baking tray or oven tray on wire shelf

Drip tray / Baking tray

Drip tray with 500 ml of water

Food probe

RECIPE	FUNCTION	PREHEAT	TEMPERATURE (°C)	DURATION (Min.)	SHELF AND ACCESSORIES
Lasagna / Flans / Baked pasta / Cannelloni		Yes	190 - 200	45 - 65	3
Lamb / Veal / Beef / Pork 1 kg		Yes	190 - 200	80 - 110	3
Roast pork with crackling 2 kg		—	170	110 - 150	2
Chicken / Rabbit / Duck 1 kg		Yes	200 - 230	50 - 100	3
Turkey / Goose 3 kg		Yes	190 - 200	80 - 130	2
Baked fish / en papillote (fillets, whole)		Yes	180 - 200	40 - 60	3
Stuffed vegetables (tomatoes, courgettes, aubergines)		Yes	180 - 200	50 - 60	2
Toast		—	3 (High)	3 - 6	5
Fish fillets / Steaks		—	2 (Mid)	20 - 30 **	4 3
Sausages / Kebabs / Spare ribs / Hamburgers		—	2 - 3 (Mid - High)	15 - 30 **	5 4
Roast chicken 1-1.3 kg		—	2 (Mid)	55 - 70 ***	2 1
Leg of lamb / Shanks		—	2 (Mid)	60 - 90 ***	3
Roast potatoes		—	2 (Mid)	35 - 55 ***	3
Vegetable gratin		—	3 (High)	10 - 25	3
Cookies	Cookies	Yes	135	50 - 70	5 4 3 1
Tarts	Tarts	Yes	170	50 - 70	5 4 3 1
Round pizzas	Pizza	Yes	210	40 - 60	5 4 2 1
Complete meal: Fruit tart (level 5) / lasagna (level 3) / meat (level 1)		Yes	190	40 - 120 *	5 3 1
Complete meal: Fruit tart (level 5) / roasted vegetables (level 4) / lasagna (level 2) / cuts of meat (level 1)	Menu	Yes	190	40 - 120 *	5 4 2 1
Lasagna & Meat		Yes	200	50 - 100 *	4 1
Meat & Potatoes		Yes	200	45 - 100 *	4 1
Fish & Vegetables		Yes	180	30 - 50 *	4 1
Stuffed roasting joints		—	200	80 - 120 *	3
Cuts of meat (rabbit, chicken, lamb)		—	200	50 - 100 *	3

* Estimated length of time: dishes can be removed from the oven at different times depending on personal preference.

** Turn food halfway through cooking.

*** Turn food two thirds of the way through cooking (if necessary).

HOW TO READ THE COOKING TABLE







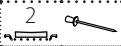
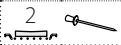
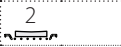
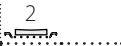
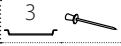
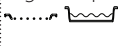

The table lists the best function, accessories and level to use to cook different types of food.

Cooking times start from the moment food is placed in the oven, excluding preheating (where required).

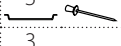
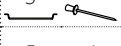
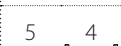
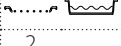
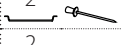
Cooking temperatures and times are approximate and depend on the amount of food and the type of accessory used.

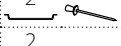
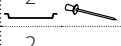
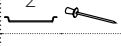
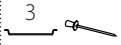
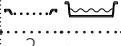
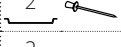
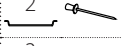
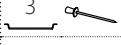
Use the lowest recommended settings to begin with and, if the food is not cooked enough, then switch to higher settings.

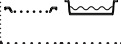
Use the accessories supplied and preferably darkcoloured metal cake tins and baking trays. You can also use Pyrex or stoneware pans and accessories, but bear in mind that cooking times will be slightly longer.

Food categories		Level and Accessories	Quantity	Cooking Info	
CASSEROLE & BAKED PASTA	Fresh	Lasagna 	500 - 3000 g *	Prepare according to your favorite recipe. Pour bechamel sauce on top and sprinkle with cheese to get perfect browning	
		Cannelloni 	500 - 3000 g *		
	Frozen	Lasagna 	500 - 3000 g		
		Cannelloni 	500 - 3000 g		
MEAT	Beef	Roast beef 	600 - 2000 g *	Brush with oil and rub with salt and pepper. Season with garlic and herbs as you prefer. At the end of cooking let rest for at least 15 minutes before carving	
		Roast veal 	600 - 2500 g *		
		Steak  	2 - 4 cm	Brush with oil and rosemary. Rub with salt and black pepper. Distribute evenly on the wire rack. Turn at 2/3 of cooking time	
		Hamburger  	1.5 - 3 cm	Brush with oil and sprinkle with salt before cooking. Turn at 3/5 of cooking time.	
		Slow cooking 	600 - 2000 g *	Brush with oil and rub with salt and pepper. Season with garlic and herbs as you prefer. At the end of cooking let rest for at least 15 minutes before carving	
	Pork	Roast Pork 	600 - 2500 g *		
		Pork Shank 	500 - 2000 g *		
		Pork Ribs  	500 - 2000 g		Brush with oil and sprinkle with salt before cooking. Turn at 2/3 of cooking time
		Bacon  	250 g		Distribute evenly on the wire shelf. Turn at 3/4 of cooking time
	Lamb	Roast Lamb 	600 - 2500 g *	Brush with oil and rub with salt and pepper. Season with garlic and herbs as you prefer. At the end of cooking let rest for at least 15 minutes before carving	
		Lamb Rack 	500 - 2000 g *		
		Lamb Leg 	500 - 2000 g *		
	Chicken	Roast Chicken 	600 - 3000 g *	Brush with oil and season as you prefer. Rub with salt and pepper. Insert into the oven with the breast side up	
		Stuffed Roast Chicken 	600 - 3000 g *		
		Chicken Pieces 	600 - 3000 g *	Brush with oil and season as you prefer. Distribute evenly in the drip tray with the skin side down	
		Chicken fillet / Breast  	1 - 5 cm		Brush with oil and sprinkle with salt before cooking. Turn at 2/3 of cooking time
	Roasted Duck	Roast Duck 	600 - 3000 g *	Brush with oil and rub with salt and pepper. Season with garlic and herbs as you prefer	
		Stuffed Roast Duck 	600 - 3000 g *		
		Duck Pieces 	600 - 3000 g *	Brush with oil and rub with salt and pepper. Season with garlic and herbs as you prefer. Turn at 2/3 of cooking time	
		Duck Fillet / Breast  	1 - 5 cm		

ACCESSORIES

 Wire shelf





































































 Oven tray or cake tin on wire shelf

 Drip tray / Baking tray or oven tray on wire shelf

 Drip tray / Baking tray

 Drip tray with 500 ml of water

 Food probe

	Food categories	Level and Accessories	Quantity	Cooking Info	
MEAT	Roasted Turkey & Goose	Roast Goose	2 	600 - 3000 g *	Brush with oil and rub with salt and pepper. Season with garlic and herbs as you prefer
		Stuffed Roast Goose	2 	600 - 3000 g *	
		Turkey Pieces	3 	600 - 3000 g *	
		Fillet / Breast	5  4 	1 - 5 cm	
Meat dishes	Kebabs	5  4 	1 grid	Brush with oil and sprinkle with salt before cooking. Turn at 1/2 of cooking time	
		Sausages & Wurstel	5  4 	1.5 - 4 cm	Distribute evenly on the wire shelf. Pierce the sausages with a fork to avoid cracking. Turn at 2/3 of cooking time
FISH	Roasted whole fish	Salmon	3  2  	0.2 - 1.5 kg *	Brush with oil and rub with salt and pepper. Season with garlic and herbs as you prefer
		Hake	3  2  	0.2 - 1.5 kg *	
		Cod	3  2  	0.2 - 1.5 kg *	
		Seabass	3  2  	0.2 - 1.5 kg *	
		Seabream	3  2  	0.2 - 1.5 kg *	
		Mullet	3  2  	0.2 - 1.5 kg *	
		Whole Fish	3  2  	0.2 - 1.5 kg *	
		Fish In Salt Crust	3 	0.2 - 1.5 kg *	
FISH	Roasted fillets & steaks	Tuna Steak	3  2 	1 - 3 cm	Brush with oil and rub with salt and pepper. Season with garlic and herbs as you prefer
		Salmon Steak	3  2 	1 - 3 cm	
		Swordfish Steak	3  2 	0.5 - 3 cm	
		Cod Steak	3  2 	100 - 300 g	
		Seabass Fillet	3  2 	50 - 150 g	
		Seabream Fillet	3  2 	50 - 150 g	
		Other Fillets	3  2 	0.5 - 3 cm	
		Fish Fillets	3  2 	0.5 - 3 cm	
Grilled seafood	Grilled seafood	Scallops	4 	one tray	Cover with breadcrumbs and season with oil, garlic, pepper and parsley
		Gratin Mussels	4 	one tray	Brush with oil and rub with salt and pepper. Season with garlic and herbs as you prefer
		Shrimps	4  3 	one tray	
		Prawns	4  3 	one tray	
VEGETABLES	Roasted Vegetables	Potatoes	3 	500 - 1500 g	
		Stuffed Vegetables	3 	100 - 500 g each	Brush with oil and rub with salt and pepper. Season with garlic and herbs as you prefer
		Other Vegetables	3 	500 - 1500 g	
	Gratin Vegetables	Potatoes	3  	1 tray	
		Tomatoes	3  	1 tray	Cover with breadcrumbs and season with oil, garlic, pepper and parsley
		Peppers	3  	1 tray	Prepare according to your favorite recipe. Sprinkle with cheese to get perfect browning
		Broccoli	3  	1 tray	Prepare according to your favorite recipe. Pour bechamel sauce on top and sprinkle with cheese to get perfect browning
		Cauliflowers	3  	1 tray	
Others	3  	1 tray			

	Food categories	Level and Accessories	Quantity	Cooking Info
CAKES & PASTRIES	Rising cakes	Sponge Cake In Tin  2 	500 - 1200 g *	Prepare a fatless sponge cake batter of 500-900g. Pour into lined and greased baking pan
		Fruit Rising Cake In Tin  2 	500 - 1200 g *	Prepare a cake batter according to your favorite recipe by using shredded or chopped-sliced fresh fruit. Pour into lined and greased baking pan
		Chocolate Rising Cake In Tin  2 	500 - 1200 g *	Prepare a fatless sponge cake batter of 500-900g. Pour into lined and greased baking pan
		Sponge Cake in Baking Tray  2 	500 - 1200 g *	Prepare a fatless sponge cake batter of 500-900g. Pour into lined and greased baking tray
	Pastries & filled pies	Cookies  3	200 - 600 g	Make a batch of 500g flour, 200g salted butter, 200g sugar, 2 egg. Flavor with fruit essence. Let cool down. Stretch evenly the dough and shape as you prefer. Lay the cookies on a baking tray
		Croissants (fresh)  3	one tray	Distribute evenly in the baking tray. Let cool down before serving
		Croissants (frozen)  3	one tray	
		Choux Pastry  3	one tray	
		Meringues  3	10 - 30 g each	Make a batch of 2 egg whites, 80g sugar and 100g desiccated coconut. Flavor with vanilla and almond essence. Shape into 20-24 pieces on greased baking tray
		Tart In Tin  3	400 - 1600 g	Make a batch of 500g flour, 200g salted butter, 200g sugar, 2 egg. Flavor with fruit essence. Let cool down. Stretch evenly the dough and fold in a tin. Fill with marmalade and cook
		Strudel  3	400 - 1600 g	Prepare a mix of diced apple, pine nuts, cinnamon and nutmeg. Put some butter in a pan, sprinkle with sugar and cook for 10-15 minutes. Roll it into a pastry and fold the external part
		Fruit filled pie  3	500 - 2000 g	Line a pie dish with the pastry and sprinkle the bottom with bread crumbs to absorb the juice from the fruit. Fill with chopped fresh fruit mixed with sugar and cinnamon
	SALTY CAKES	Salty cake  2	800 - 1200 g	Line a pie dish for 8-10 portions with a pastry and pierce it with a fork. Fill the pastry according to your favorite recipe
Vegetable Strudel  2		500 - 1500 g	Prepare a mix of chopped vegetable. Sprinkle with oil and cook into a pan for 15-20 minutes. Let cool down. Add fresh cheese and season with salt, balsamic vinegar and spices. Roll it into a pastry and fold the external part	

ACCESSORIES

 Wire shelf













 Oven tray or cake tin on wire shelf

 Drip tray / Baking tray or oven tray on wire shelf

 Drip tray / Baking tray

 Drip tray with 500 ml of water

 Food probe

	Food categories	Level and Accessories	Quantity	Cooking Info
BREAD	Rolls	3 	60 - 150 g each *	Prepare dough according to your favorite recipe for a light bread. Form to rolls before rise. Use the oven dedicated function to rise
	Medium Size Bread	3 	200 - 500 g each *	Prepare dough according to your favorite recipe and place it on baking tray
	Sandwich Loaf in Tin	2 	400 - 600g each *	Prepare dough according to your favorite recipe for a light bread. Form into a loaf container before rise. Use the oven dedicated function to rise
	Big Bread	2 	700 - 2000 g *	Prepare dough according to your favorite recipe and place it on baking tray
	Wholegrain	2 	500 - 2000 g *	
	Baguettes	3 	200 - 300g each *	Prepare dough according to your favorite recipe for a light bread. Form to baguette rolls before rise. Use the oven dedicated function to rise
	Special Bread	2 	-	Prepare dough according to your favorite recipe and place it on baking tray
PIZZA	Pizza Thin	2 	round - tray	Prepare a pizza dough based on 150ml water, 15g yeast, 200-225g flour, oil and salt. Rise it using the dedicated oven function. Roll out the dough into a lightly greased baking tray. Add topping like tomatoes, mozzarella and ham
	Pizza Thick	2 	round - tray	
	Pizza Frozen	  	1 - 4 layers	Take out from packaging. Distribute evenly on the wire shelf

ACCESSORIES

 Wire shelf

 Oven tray or cake tin on wire shelf

 Drip tray / Baking tray or oven tray on wire shelf

 Drip tray / Baking tray

 Drip tray with 500 ml of water

 Food probe

CLEANING AND MAINTENANCE

Make sure that the oven has cooled down before carrying out any maintenance or cleaning. Do not use steam cleaners.

Do not use wire wool, abrasive scourers or abrasive/corrosive cleaning agents, as these could damage the surfaces of the appliance.

Wear protective gloves. The oven must be disconnected from the mains before carrying out any kind of maintenance work.

EXTERIOR SURFACES

- Clean the surfaces with a damp microfibre cloth. If they are very dirty, add a few drops of pH-neutral detergent. Finish off with a dry cloth.
- Do not use corrosive or abrasive detergents. If any of these products inadvertently comes into contact with the surfaces of the appliance, clean immediately with a damp microfibre cloth.

INTERIOR SURFACES

- After every use, leave the oven to cool and then clean it, preferably while it is still warm, to remove any deposits or stains caused by food residues. To dry any condensation that has formed as a result

of cooking foods with a high water content, let the oven to cool completely and then wipe it with a cloth or sponge.

- Clean the glass in the door with a suitable liquid detergent.
- The oven door can be removed to facilitate cleaning.

ACCESSORIES

Soak the accessories in a washing-up liquid solution after use, handling them with oven gloves if they are still hot. Food residues can be removed using a washing-up brush or a sponge.

REMOVING AND REFITTING THE DOOR

1. To remove the door, open it fully and lower the catches until they are in the unlock position.

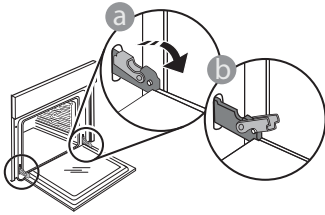

2. Close the door as much as you can. Take a firm hold of the door with both hands – do not hold it by the handle. Simply remove the door by continuing to close it while pulling it upwards at the same time until it is released from its seating. Put the door to one side, resting it on a soft surface.

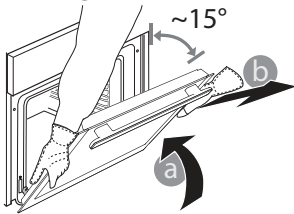

Refit the door by moving it towards the oven, aligning the hooks of the hinges with their seating and securing the upper part onto its seating.

3. Lower the door and then open it fully. Lower the catches into their original position: Make sure that you lower them down completely.

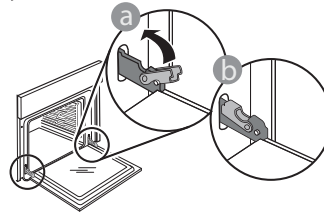

Apply gentle pressure to check that the catches are in the correct position.

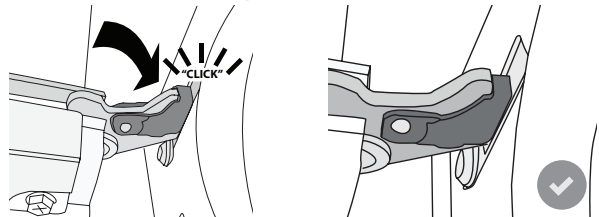

4. Try closing the door and check to make sure that it lines up with the control panel. If it does not, repeat the steps above: The door could become damaged if it does not work properly.

REPLACING THE LAMP

1. Disconnect the oven from the power supply.
2. Remove the shelf guides.
3. Remove the lamp cover.
4. Replace the lamp.
5. Reposition the lamp cover, pushing it on firmly until it snaps into place.
6. Refit the shelf guides.
7. Reconnect the oven to the power supply.

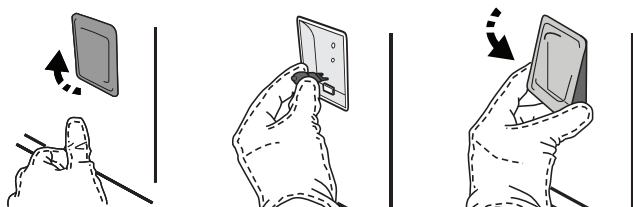

Please note: Only use 20-40 W/230 ~ V type G9, T300°C halogen bulbs. The bulb used in the product is specifically designed for domestic appliances and is not suitable for general room lighting within the home (EC Regulation 244/2009). Light bulbs are available from our After-sales Service.

- If using halogen bulbs, do not handle them with your bare hands as your fingerprints could cause damage. Do not use the oven until the light cover has been refitted.

WIFI FAQs

Which WiFi protocols are supported?

The WiFi adapter installed supports WiFi b/g/n for European countries.

Which settings need to be configured in the router software?

The following router settings are required: 2.4 GHz enabled, WiFi b/g/n, DHCP and NAT activated.

Which Version of WPS is supported?

WPS 2.0 or higher. Check the router documentation.

Are there any differences between using a smartphone (or tablet) with Android or iOS?

You can use whichever operating system you prefer, it makes no difference.

Can I use mobile 3G tethering instead of a router?

Yes, but cloud services are designed for permanently connected devices.



How can I check whether my home Internet connection is working and wireless functionality is enabled?

You can search for your network on your smart device. Disable any other data connections before trying.

How can I check whether the appliance is connected to my home wireless network?

Access your router configuration (see router manual) and check whether the appliance's MAC address is listed on wireless connected devices page.

Where can I find the appliance's MAC address?

Press  then tap  WiFi or look on your appliance: There is a label showing the SAID and MAC addresses. The MAC address consists of a combination of numbers and letters starting with "88:e7".

How can I check whether the appliance's wireless functionality is enabled?

Use your smart device and the 6th Sense Live app to check whether the appliance network is visible and connected to the cloud.

Is there anything that can prevent the signal reaching the appliance?

Check that the devices you have connected are not using up all the available bandwidth. Make sure that your WiFi-enabled devices do not exceed the maximum number permitted by the router.

How far should the router be from the oven?

Normally the WiFi signal is strong enough to cover a couple of rooms, but this very much depends on the material the walls are made of. You can check the signal strength by placing your smart device next to the appliance.

What can I do if my wireless connection does not reach the appliance?

You can use specific devices to extend your home WiFi coverage, such as access points, WiFi repeaters and power line bridges (not provided with appliance).

How can I find out the name of and password for my wireless network?

See the router documentation. There is usually a sticker on the router showing the information you need to reach the device setup page using a connected device.

What can I do if my router is using the neighbourhood WiFi channel?

Force the router to use your home WiFi channel.

What can I do if  appears on the display or the oven is unable to establish a stable connection to my home router?

The appliance might have successfully connected to the router, but it is not able to access the Internet. To connect the appliance to the Internet, you will need to check the router and/or carrier settings.

Router settings: NAT must be on, Firewall and DHCP must be properly configured. Password encryption supported: WEP, WPA,WPA2. To try a different encryption type, please refer to the router manual.

Carrier settings: If your Internet service provider has fixed the number of MAC addresses able to connect to the Internet, you may not be able to connect your appliance to the cloud. The MAC address of a device is its unique identifier. Please ask your Internet service provider how to connect devices other than computers to the Internet.

How can I check whether data is being transmitted?

After setting up the network, switch the power off, wait 20 seconds and then switch on the oven: Check that the app is showing the UI status of the appliance. Select a cycle or another option and check its status on the app.

Some settings take several seconds to appear in the app.









How can I change my Whirlpool account but keep my appliances connected?

You can make a new account but remember to unclaim your appliance from the old account before to move them to new one.

I changed my router – what do I need to do?

You can either keep the same settings (network name and password) or delete the previous settings from the appliance and configure the settings again.

TROUBLESHOOTING

Problem	Possible cause	Solution
The oven is not working.	Power cut. Disconnection from the mains.	Check for the presence of mains electrical power and whether the oven is connected to the electricity supply. Turn off the oven and restart it to see if the fault persists.
The display shows the letter "F" followed by a number or letter.	Oven failure.	Contact your nearest Client After-sales Service Centre and state the number following the letter "F". Press  , tap  "Info" and then select "Factory Reset". All settings saved will be deleted.
The home power goes off.	Power setting wrong.	Verify if your domestic network has at least a rating of more than 3 kW. If no, decrease the power to 13 Ampere. To change it, press  , select  "More Modes" and then select "Power Management".
The function does not start. The function is not available in demo mode.	Demo mode is running.	Press  , tap  "Info" and then select "Store Demo Mode" to exit.
The  icon is shown on display.	The WiFi router is off. The router settings have changed. The wireless connections does not reach the appliance. The oven is unable to establish a stable connection to home network. The connectivity is not supported.	Check that the WiFi router is connected to the Internet. Check that the WiFi signal close to the appliance is strong. Try to restart the router. See the "WiFi FAQs" section. If your home wireless network settings have changed, connect to the network: Press  , tap  "WiFi" and then select "Connect to network".
Connectivity is not supported.	Remote operation is not permitted in your country.	Check whether your country allows remote operation of electronic appliances before purchasing.
The touch screen display is not working properly.	Prolonged use. Overload system.	Press and hold **G3OV_ONOFF.eps** for at least 4 seconds. Switch the oven on and see if the fault persists.



You can download the Safety Instructions, User Manual, Product Fiche and Energy data by:

- Visiting our website docs.whirlpool.eu
- Using QR Code
- Alternatively, **contact our After-sales Service** (See phone number in the warranty booklet). When contacting our After-sales Service, please state the codes provided on your product's identification plate.

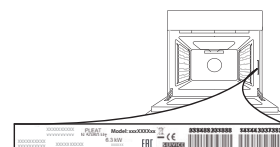

Whirlpool



400011401936