

Gebrauchsanweisung

Instructions for use

Mode d'emploi

Gebruiksaanwijzing

Istruzioni per l'uso



Brugsanvisning

Bruksanvisning

Käyttöohje

Manual de utilização

Instrucciones para el uso



Οδηγίες χρήσης

Instrukcje użytkowania

Használati utasítás

Инструкция за употреба

Navodila za uporabo

Upute za uporabu



Návod k použití

Návod na použitie

Instrucțiuni de utilizare

Инструкции по эксплуатации

Uputstvo za upotrebu

**Whirlpool**

SENSING THE DIFFERENCE

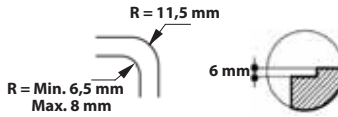
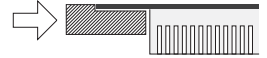
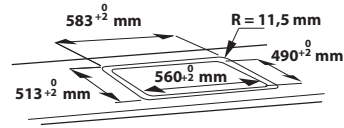
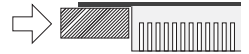
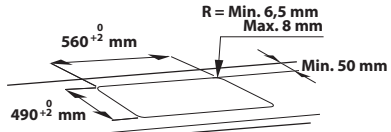
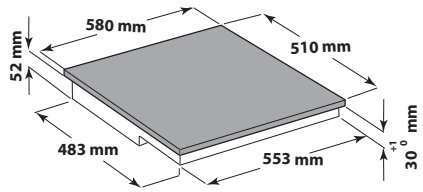
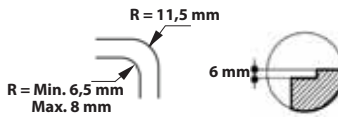
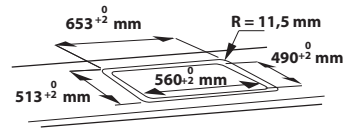
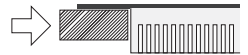
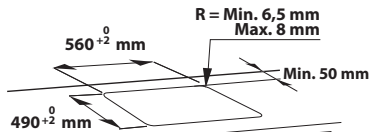
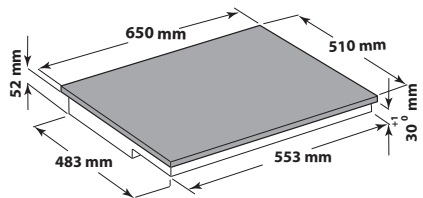
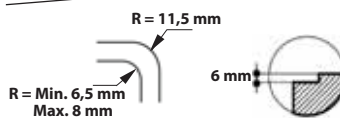
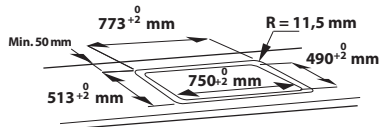
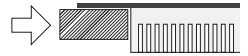
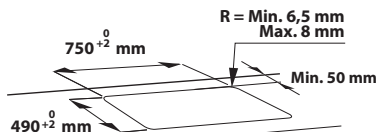
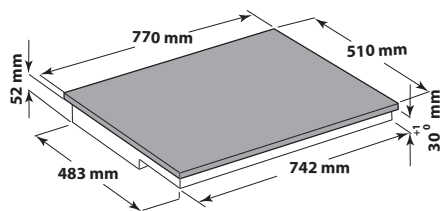
A**B****C**

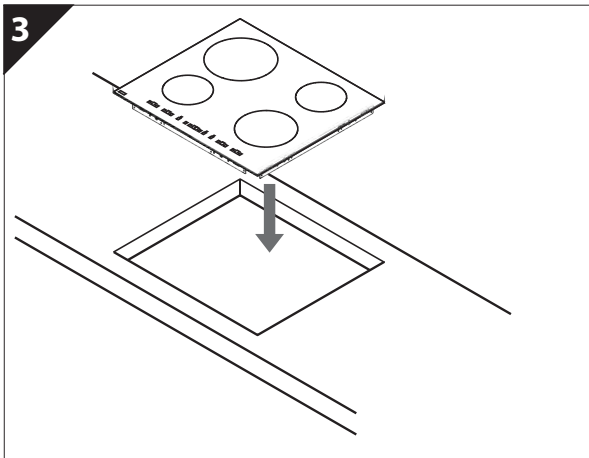
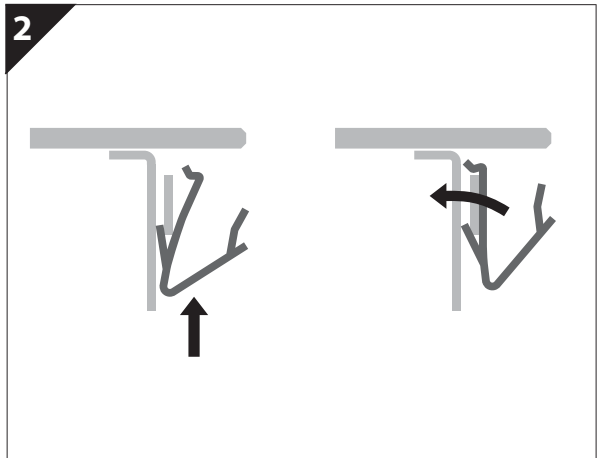
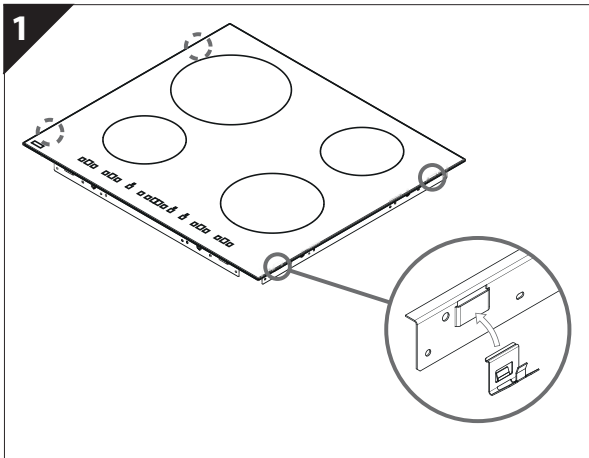
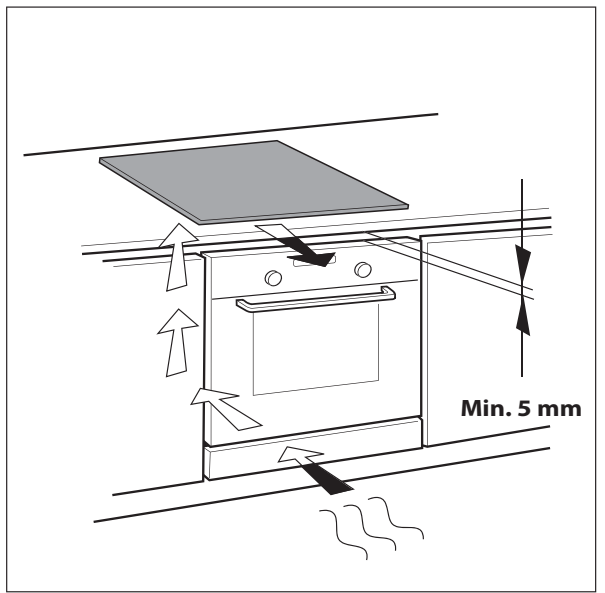
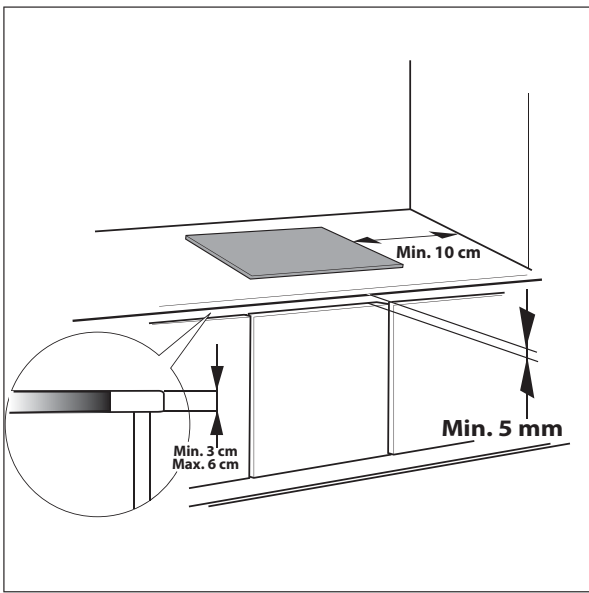

IMPORTANT SAFETY INSTRUCTIONS

YOUR SAFETY AND THAT OF OTHERS IS VERY IMPORTANT

This manual and the appliance itself provide important safety messages, to be read and always observed.

 This is the danger symbol, regarding safety, warning of potential risks to users and others.
All safety messages will be preceded by the danger symbol and the following words:

 **DANGER** Indicates a hazardous situation which, if not avoided, will result in serious injury.

 **WARNING** Indicates a hazardous situation which, if not avoided, could cause serious injury.

All messages relevant to safety specify the potential risk to which they refer and indicate how to reduce the risk of injury, damage and electric shocks due to incorrect use of the appliance. Make sure to comply with the following:

- The appliance must be disconnected from the power supply before carrying out any installation operation.
- Installation and maintenance must be carried out by a specialised technician, in compliance with the manufacturer's instructions and the local safety regulations in force. Do not repair or replace any part of the appliance unless specifically stated in the user manual.
- The appliance must be earthed.
- The power cable must be long enough for connecting the appliance, fitted in the cabinet, to the power supply.
- For installation to comply with the current safety regulations, an omnipolar switch with minimum contact gap of 3mm is required.
- Do not use multi-sockets or extension cords.
- Do not pull the appliance's power cable.
- The electrical parts must not be accessible to the user after installation.
- The appliance is designed solely for domestic use for cooking food. No other use is permitted (e.g. heating rooms). The Manufacturer declines any liability for inappropriate use or incorrect setting of the controls.
- The appliance and its accessible parts become hot during use. Care should be taken to avoid touching heating elements. Children less than 8 years old shall be kept away unless continuously supervised.
- The accessible parts can become very hot during use. Children must be kept away from the appliance and watched over to ensure they do not play with it.
- Do not touch the appliance heating elements during and after use. Do not allow the appliance to come into contact with cloths or other flammable materials until all the components have cooled sufficiently.
- Do not place flammable materials on or near the appliance.
- Overheated oils and fats catch fire easily. Pay attention when cooking food products rich in fat and oil.
- This appliance can be used by children aged from 8 years and above and persons with reduced physical, sensory or mental capabilities or lack of experience and knowledge if they have been given supervision or instruction concerning use of the appliance in a safe way and understand hazards involved. Children shall not play with the appliance. Cleaning and user maintenance shall not be made by children without supervision.
- A separator panel (not supplied) must be installed in the compartment under the appliance.
- If the surface is cracked, switch off the appliance to avoid the possibility of electric shock.
- The appliance is not intended to be operated by means of an external timer or separate remote control system.
- Unattended cooking on a hob with fat or oil can be dangerous and may result in fire. NEVER try to extinguish a fire with water, but switch off the appliance and then cover flame e.g. with a lid or a fire blanket.
Danger of fire: do not store items on the cooking surfaces.
- Do not use steam cleaners.
- Metallic objects such as knives, forks, spoons and lids should not be placed on the hob surface since they can get hot.
- After use, switch off the hob element by its control and do not rely on the pan detector.

SAFEGUARDING THE ENVIRONMENT

Disposal of packaging materials

The packaging material is entirely recyclable and marked with the recycling symbol (♻️). Do not dispose of the various packaging materials carelessly, but do so responsibly and in full compliance with local authority regulations governing waste disposal.

Scrapping

This appliance is marked in compliance with European Directive 2002/96/EC on Waste Electrical and Electronic Equipment (WEEE).

By ensuring that this appliance is scrapped suitably, you can help prevent potentially damaging consequences for the environment and health.

The symbol  on the appliance or accompanying documentation indicates that this product should not be disposed of as unsorted municipal waste but must be taken to a collection point for the treatment of WEEE.

Energy saving

For optimum results, observe the following advice:

- Use pots and pans whose bottom diameter is equal to that of the cooking zone.
- Only use flat-bottomed pots and pans.
- If possible, keep pot lids on when cooking.
- Use a pressure cooker to save even more energy and time (do not use in conjunction with the sixth sense function).
- Make sure you place the pot or pan in the centre of the cooking zone outlined on the hob.

DECLARATION OF CONFORMITY

- This appliance is designed to come into contact with food and complies with Regulation (CE) no. 1935/2004, and has been designed, constructed and marketed in compliance with the safety requirements of "Low Voltage" Directive 2006/95/EC (replacing 73/23/EEC as amended) and protection requirements of "EMC" Directive 2004/108/EC.

BEFORE USE



IMPORTANT: the cooking zones will not switch on if pots and pans are not of the correct dimensions. Only use pots bearing the symbol "INDUCTION SYSTEM" (See figure opposite). Before switching the hob on, position the pot on the desired cooking zone.



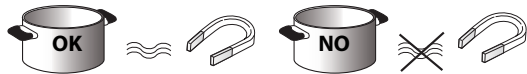









EXISTING POTS AND PANS



Use a magnet to check whether pots or pans are suitable for use on the induction hob: pots are unsuitable if they cannot be magnetically detected.

- Ensure pots have a smooth bottom, otherwise they may scratch the hob's glass ceramic surface. Check dishes.
- Never place hot pots or pans on the hob's control panel. This could result in damage.

RECOMMENDED DIAMETERS OF POT BOTTOMS

 XL ∅ 30 cm		∅ 14 cm (Dual Zone) → ∅ 30 cm	 XL ∅ 28 cm		18 cm 14 cm (Dual zone) → ∅ 28 cm
 L ∅ 24 cm		∅ 17 cm → ∅ 24 cm	 L ∅ 21 cm		15 cm → ∅ 21 cm
 M ∅ 18 cm		∅ 14 cm → ∅ 18 cm	 S ∅ 14.5 cm		11 cm → ∅ 14.5 cm

IMPORTANT: for the diameter of pot bottoms on zones which can be used with the "sixth sense" function, see paragraph "Sixth Sense Function".

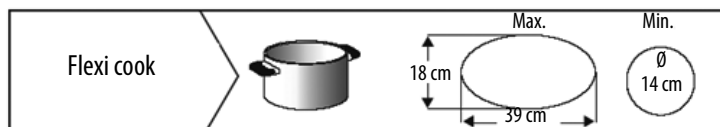

INSTALLATION

After unpacking the hob, check that there has been no damage during transport. If in doubt, contact the dealer or After-sales Service.

PREPARING THE HOUSING UNIT

WARNING

- Install a separator panel under the hob.
- The lower part of the product must not be accessible after installation.
- If there is an oven beneath the hob, do not install the separator panel.

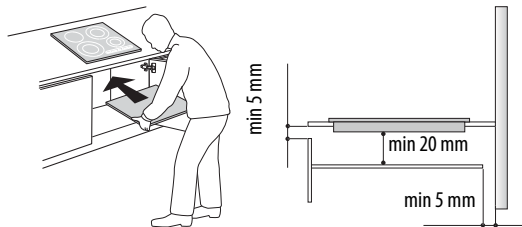

- For the distance between the underside of the appliance and the separator panel below, observe the dimensions given in the figure.
- In order to ensure the correct operation of the product, do not obstruct the minimum required clearance between the hob and the top of the unit (min. 5 mm).
- Cut the worktop to fit before installing the hob and carefully remove any shavings or sawdust.
- If an oven is installed beneath the hob, make sure that it is equipped with a cooling system.
- In the case of flush-mounted installation, call the After-Sales Service to request assembly of screws kit 4801 211 00112.
- To remove the hob from the worktop use a screw driver (not supplied) unlocking the springs from the bottom side of the appliance.
- Do not install the hob above a dishwasher or washing machine, to prevent the electronic circuits from coming into contact with steam or moisture and being damaged as a result.

ELECTRICAL CONNECTION

WARNING

- Disconnect the appliance from the mains power supply.
- The appliance must be installed by a qualified technician who is fully aware of current safety and installation regulations.

- The manufacturer declines all liability for injury to persons or animals and for damage to property resulting from failure to observe the regulations provided in this chapter.
- The power supply cable must be long enough to allow the hob to be removed from the worktop.
- Make sure the voltage specified on the appliance rating plate is the same as that of the domestic power supply voltage.
- Do not use extension cables.

Connecting to the terminal board

For electrical connection, use an H05RR-F cable as specified in the table below.

Conductors	Amount x size
230 V ~ + (⊕)	3 x 4 mm ²
230-240 V ~ + (⊕)	3 X 4 mm ² (Australia only)
230 V 3 ~ + (⊕)	4 X 1.5 mm ²
400 V 3N ~ + (⊕)	5 X 1.5 mm ²
400 V 2N ~ (⊕)	4 X 1.5 mm ²

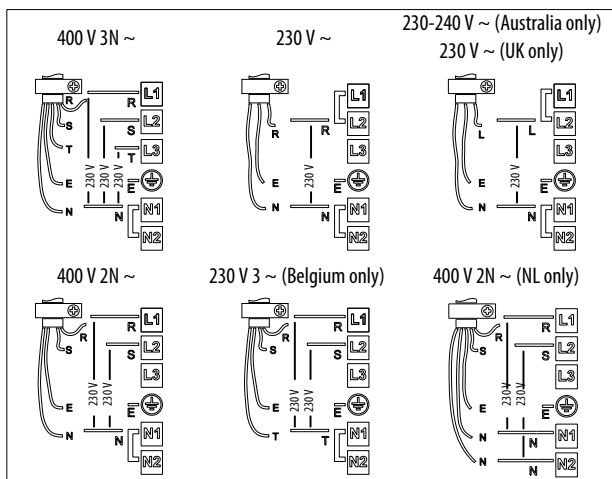
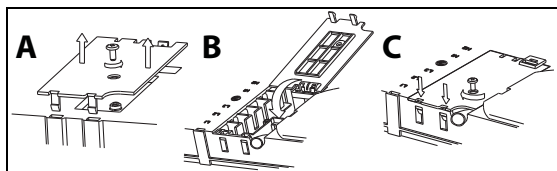

Connect the yellow/green earth wire to the terminal with the symbol (⊕).

This wire must be longer than the other wires.

1. Remove the terminal block cover (A), undoing the screw and inserting the cover in the terminal block hinge (B).
2. Insert the power supply cable into the cable clamp and connect the wires to the terminal board as indicated in the diagram next to the terminal board itself.
3. Secure the power cable with the cable clamp.
4. Close the cover (C) and screw it on the terminal block with the removed screw - point (1).

Each time the cooktop is connected to the mains it carries out an automatic check which lasts several seconds.

If the hob already has a power cable, follow the instructions given on the label attached to the cable. Connect the appliance to the electricity supply by means of an all-pole disconnect switch with minimum contact gap of 3 mm.

INSTRUCTIONS FOR USE

Control Panel Description

The control panel is equipped with touch controls: to use them, just press the corresponding symbol (a light touch is sufficient).

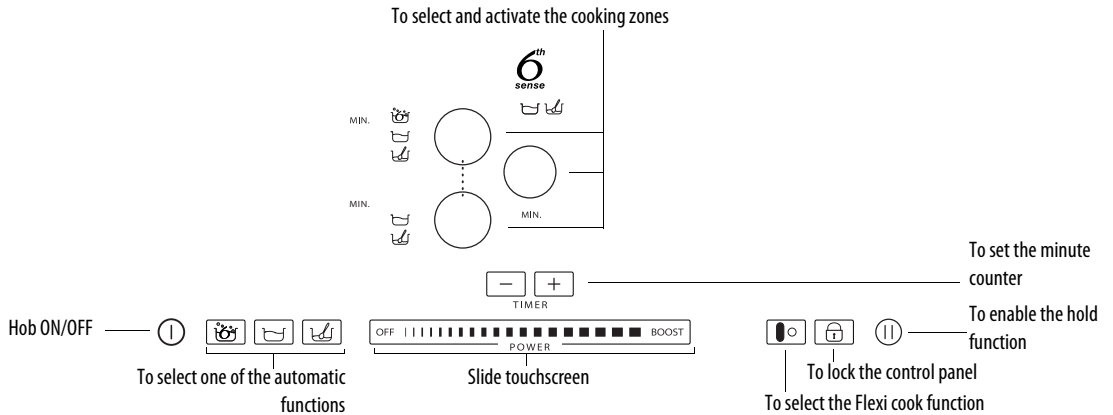

First use / after a power failure

After connecting the hob to the electrical power supply, the control panel is locked (the indicator light above the key is ON).

To unlock the control panel, press and hold the  key for 3 seconds. The indicator light switches off and the hob can be used normally.

Switching the hob ON/OFF

To switch the hob on, press and hold the  key for approx. 2 seconds: the indicator light above the key turns on and hyphens appear inside the circles which represent the cooking zones.

To switch off, press the same key until the hob switches off. All the cooking zones are switched off.



The hob automatically switches off if no function is selected within 10 seconds of switching on.

Switching on and adjusting cooking zones

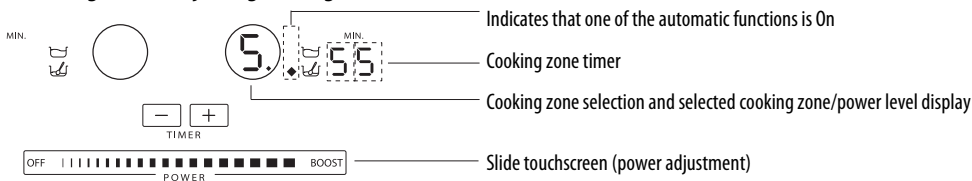

After switching on the hob, position the pot on the chosen cooking zone.

Activate the cooking zone by pressing the relative round key: the round key displays number 5 which corresponds to the intermediate power level.

To change the power level, move your finger horizontally on the slide touchscreen: the number inside the circle will change with just a quick slide of the finger from a minimum of 1 to a maximum of 9. You can activate the booster function by pressing "BOOST" on the slide touchscreen ("P" on the display). The "BOOST" power function can be used for a maximum of 10 minutes, after which the appliance automatically sets the power level at level 9. In models with three cooking zones, three "BOOST" levels can be selected at the same time: in this case the appliance automatically adapts the power distribution between the three zones.

5.

If more than one cooking zone is on, the slide touchscreen allows you to change the power level of the selected zone, indicated by the presence of a luminous dot at the bottom right of the power level indicator. To select a zone, simply press the relative round key.

4.4

If you are using a pot that is not suitable, not correctly positioned or not of the correct dimensions for your induction hob, the message "no pot" will appear in the display (see figure on the left). If no pot is detected within 60 seconds, the hob switches off.

Switching off cooking zones

Select the cooking zone to be switched off by pressing the relative round key (a dot lights up at the bottom right of the power level indicator). Press OFF on the slide touchscreen.

H

The cooking zone switches off and, if the zone is still hot, the letter "H" appears in the circle.

"H" is the residual heat indicator. The hob is fitted with a residual heat indicator for each cooking zone; these indicators alert the user when cooking zones are still hot. When the cooking zone cools down, the display switches off.

Timer selection

The timer can be used to set a max. cooking time of 90 minutes.

Select the cooking zone to be used with the timer (a dot lights up at the bottom right of the power level indicator), then set the required cooking time using the + and - keys of the timer function: the time in minutes is shown next to the cooking zone display.

A few seconds after the key is pressed, the timer begins the countdown (the luminous dot of the selected cooking zone starts flashing).

Once the set time has elapsed, an acoustic signal sounds and the cooking zone switches off automatically.

For use if the timer in conjunction with the sixth sense function, see the description of the function in subsequent pages.

Control panel lock



This function locks the hob controls to prevent accidental switching on (e.g. during cleaning).

Press the  key for three seconds: an acoustic signal sounds and an indicator light turns on above the lock symbol to confirm activation. The control panel is locked with the exception of the OFF function. To unlock the controls, repeat the child safety activation procedure. The illuminated dot switches off and the hob is active again.

IMPORTANT: The presence of water, liquid spilled from pots or objects of any nature resting on the key below the symbol can accidentally activate or deactivate the Control panel lock function.

Hold

This function allows you to temporarily hold and then resume cooking processes, maintaining previous settings (except for the sixth sense function and any set timers).



Press the  key:  blinks on the display in place of the power levels. To resume cooking, press the  key again.

Flexi cook

This function allows you to use the cooking area as two separate cooking zones or as an extra-large single zone.

It is perfect for oval, rectangular and elongated pans (with maximum base dimensions of 38x18 cm) or more than one standard pan. In order to activate the flexicook function, switch on the hob and press the button : the two cooking zone displays show level "5"; both dots next to the level number are lit, indicating that the Flexi cook is activated.

To change the power level, move your finger along the slide touchscreen: the number inside the circle will change with just a quick slide of the finger from a minimum of 1 to a maximum of 9. To deactivate the flexible zone function, press the key : the cooking zones revert to operating singly again. To switch the cooking zone off, press OFF

 The message "no pot"  will appear on the display of the zone that is not able to detect any pot (because of missing pot, or misplaced or not suitable for induction hob). This message remains active for 60 seconds: in this time you can add or slide pots within the flexicook area as you prefer.

After 60 seconds if no pan is placed on the zone, the system stops "searching" pots on that zone, the symbol  remains visible on the display to remind that the zone is disabled.

To reactivate the Flexicook function on both heaters, press the button .

The Flexi cook function is also able to detect when a pot is moved from one zone to the other one within the flexi cook area keeping the same power level of the zone where the pan originally was placed (see the example in the figure below: if the pot is moved from the front heater to the rear heater, the power level will be shown on the display corresponding to the zone where the pot is placed).

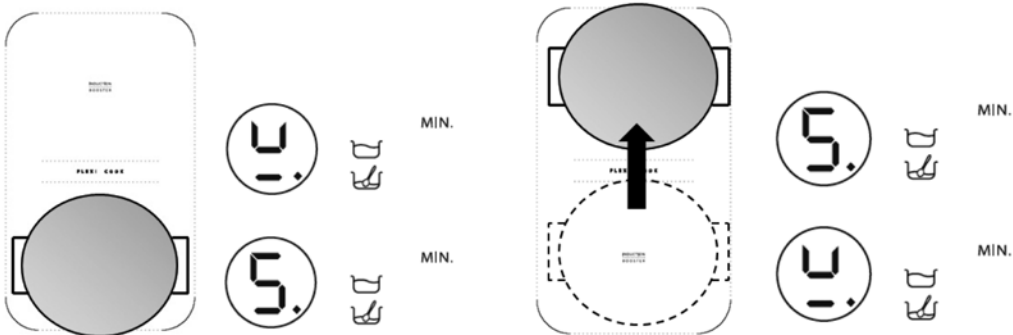

It is also possible to operate the Flexi cook area as two independent cooking zones, using the corresponding button of the single zone. Place the pot in the center of the single zone and adjust the power level with the slide touchscreen.

 Important: make sure to place the pans centered on the cooking zone in the way to cover the logo  placed in the center of the single cooking zone.

In case of big pot, oval, rectangular and elongated pans make sure to place the pans centered on the cooking zone covering both  logos.

Examples of good pot placement and bad pot placement :

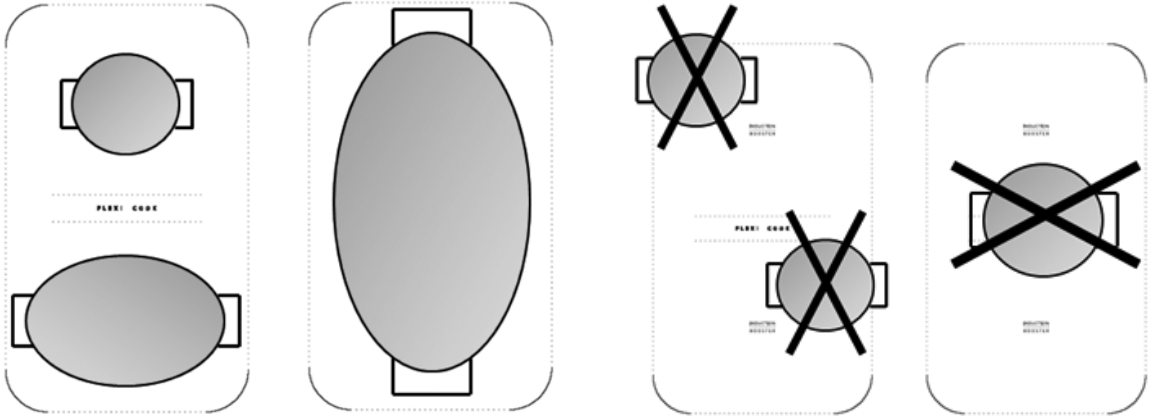

When the flexi cook function is selected, the booster and sixth sense functions cannot be used. If the timer is set, it will be displayed alongside the hotplate display at the top.

Description of automatic functions



The hob features automatic functions for each cooking zone. The symbols of the available functions are shown next to the selection key of each cooking zone. Every time an automatic function is selected, an indicator light turns on next to the symbol and the letter "A" appears in the cooking zone display.

Sixth Sense

The Sixth Sense function automatically selects the ideal power setting for bringing water to the boil and signals when boiling point is reached.

After positioning the pot of water, switch on the hob and select the desired cooking zone. Press the  key: "A" appears on the display and the indicator light turns on. During heating, an animation is displayed in the space next to the cooking zone.



For correct operation of the sixth sense function, please observe the following recommendations:

- use water only (at room temperature);
- do not add salt, other ingredients or condiments until the water reaches boiling point;
- do not change the power setting of the cooking zone or remove or move the pot;
- fill the pot to at least 1/3 full (min. 1 litre) and never to the brim (see table on the right).
- Do not use a pressure cooker on the zone with the sixth sense function selected;

For optimum results, observe the following advice:

- Do not activate the sixth sense function if the zone is already hot (letter "H" visible on display).

Cooking zone diameter	Pot base diameter for use of 6th Sense function	Maximum amount of water in the pot
18 cm	17-19 cm	5 litres
24 cm	23-25 cm	7 litres
28 cm	24-28 cm	7 litres

When the water comes to the boil, the hob emits an acoustic signal. This signal is sounded three times at regular intervals. After the second signal, a minute minder is automatically activated to keep track of boiling time. After the third signal, the hob automatically selects a lower power setting to keep the water simmering. From this moment on, you can add any ingredients you like, set the timer and change the power setting. Changing the power setting or selecting the "hold" function overrides the sixth sense function.



The hob features automatic management of the use of the sixth sense function and booster settings, therefore in some cases it may not be possible to select the booster when the sixth sense function is already selected on other cooking zones.

The quality of the pot used may have a bearing on sixth sense function performance.

Simmering

After bringing to the boil, press the key  and the hob will automatically set the correct power level to keep the pot simmering. "A" appears on the display: the indicator light lights up. To deactivate the function, simply press OFF on the slide touchscreen.

Melting

This function maintains a permanently low temperature in the cooking zone. After positioning the pot/accessory on the chosen cooking zone, switch on the hob and select the cooking zone. Press the  key: "A" appears on the display and the indicator light turns on. To deactivate the function, simply press OFF on the slide touchscreen.

CLEANING

WARNING

- Never use steam cleaners.
- Before cleaning, make sure the cooking zones are switched off and that the residual heat indicator (“H”) is not displayed.

IMPORTANT: do not use abrasive sponges or pan scourers, as they could ruin the glass surface.

- Clean the hob, when it is cool, after each use in order to remove any food residues.
- Sugar and foods with a high sugar content damage the glass ceramic surface and must be immediately removed.
- Salt, sugar and sand can scratch the glass surface.
- Use a soft cloth, absorbent kitchen wipes or a specific hob cleaner (follow the Manufacturer’s instructions).

TROUBLESHOOTING GUIDE

- Read and follow the instructions given in the section “Instructions for use”.
- Check that the electricity supply has not been shut off.
- Clean the hob and dry it thoroughly.
- If, when the hob is switched on, alphanumeric codes appear on the display, consult the following table for instructions.
- If you are unable to turn the hob off after using it, disconnect it from the power supply.

ERROR CODE	DESCRIPTION	POSSIBLE CAUSES	REMEDY
The hob switches off and after 10 seconds emits an acoustic signal every 30 seconds.	Continuous pressure on control panel area.	Water or utensils on control panel.	Clean the control panel.
C81, C82, C83	The control panel switches off because of excessively high temperatures.	The internal temperature of electronic parts is too high.	Wait for the hob to cool down before using it again.
F42 or F43	The connection voltage is wrong.	The sensor detects a discrepancy between the appliance voltage and that of the mains supply.	Disconnect the hob from the mains and check the electrical connection.
F12, F21, F25, F36, F37, F40, F47, F56, F58, F60, F61, F62, F63, F64	Call the After-sales Service and specify the error code.		

AFTER-SALES SERVICE

Before contacting After-sales Service

1. See if you can solve the problem yourself with the help of the suggestions given in the “Troubleshooting guide”.
2. Switch the appliance off and then on again it to see if the problem has been eliminated.

If after the above checks the fault persists, contact the nearest After-sales Service.

Always specify:

- a brief description of the fault;
- the type and exact model of the hob;
- the Service number (the number after the word Service on the rating plate) located under the appliance (on the metal plate);
- your full address;
- your telephone number and area code.





SERVICE 0000 000 00000



If any repairs are required, please contact an **authorised After-Sales Service** (to guarantee that original spare parts will be used and repairs carried out correctly). Spare parts are available for 10 years.

POWER LEVEL TABLE

Power level		Type of cooking	Level use (indicating cooking experience and habits)
Max. power	Boost	Fast heating	Ideal for rapidly increasing the temperature of food to fast boiling in the case of water or rapidly heating cooking liquids
	8-9	Frying - boiling	Ideal for browning, starting to cook, frying deep frozen products, fast boiling
High power	7-8	Browning - sautéing - boiling - grilling	Ideal for sautéing, maintaining a lively boil, cooking and grilling (for a short period of time, 5-10 minutes)
	6-7	Browning - cooking - stewing - sautéing - grilling	Ideal for sautéing, maintaining a light boil, cooking and grilling (for a medium period of time, 10-20 minutes), preheating accessories
Medium power	4-5	Cooking - stewing - sautéing - grilling	Ideal for stewing, maintaining a gentle boil, cooking (for a long period of time). Creaming pasta
	3-4	Cooking - simmering - thickening - creaming	Ideal for long-cooking recipes (rice, sauces, roasts, fish) with liquids (e.g. water, wines, broth, milk), creaming pasta
	2-3		Ideal for long-cooking recipes (quantities under 1 litre: rice, sauces, roasts, fish) with liquids (e.g. water, wine, broth, milk)
Low power	1-2	Melting - defrosting - keeping food warm - creaming	Ideal for softening butter, gently melting chocolate, thawing small products and keeping just-cooked food warm (e.g. sauces, soups, minestrone)
	1		Ideal for keeping just-cooked food warm, for creaming risottos and for keeping serving dishes warm (with induction-suitable accessory)
OFF	Zero power	Support surface	Hob in stand-by or off mode (possible end-of-cooking residual heat, indicated by an "H")

Function		Description of function
	Simmering	Automatically identifies a power level that is suitable for simmering long-cooking recipes. Suitable for cooking tomato sauce, ragu, soups, minestrone, maintaining a controlled cooking level (ideal for cooking in a bain-marie). Prevents food from boiling over (e.g. spurting) or sticking to the bottom and burning, as often happens with these recipes. Use this function after bringing the pot to the boil.
	Melting	Automatically identifies a power level that is suitable for slowly melting delicate products without compromising their sensorial quality (chocolate, butter, etc.).
	6th Sense Sixth sense bringing water to the boil	Automatically identifies when water reaches boiling point and reduces the power to maintain the boil until the food is added. When the water reaches boiling point an acoustic signal is emitted, and any ingredients can be added (e.g. condiments, pasta, rice, vegetables, meat and fish to be boiled) but also homemade preserves or accessories to be sterilized.
	Flexi cook	This function combines two cooking zones and allows you to exploit the combined surface area for large rectangular or oval shaped cooking receptacles or grilles. For grilling large quantities or pieces of food (fish, kebabs, vegetables like red chicory, steaks, German sausages). For cooking recipes like rolled roast joints or whole fish, generally accompanied with a sauce or stock, using a casserole dish/fish kettle/pan

COOKING TABLE

Food categories	Dishes or type of cooking	Power level and cooking status			
		First stage	Power	Second stage	Power
Pasta, rice	Fresh pasta	Heating the water	Booster - 9	Cooking the pasta and maintaining the boil	7-8
	Dry pasta	Heating the water	Booster - 9	Cooking the pasta and maintaining the boil	7-8
	Boiled rice	Heating the water	Booster - 9	Cooking the pasta and maintaining the boil	5-6
	Risotto	Sautéing and roasting	7-8	Cooking	4-5
Vegetables, pulses	Boiled	Heating the water	Booster - 9	Boiling	6-7
	Fried	Heating the oil	9	Frying	8-9
	Sautéed	Heating the accessory	7-8	Cooking	6-7
	Stewed	Heating the accessory	7-8	Cooking	3-4
	Light fried	Heating the accessory	7-8	Browning the food	7-8
Meat	Roast	Browning the meat with oil (if with butter power level 6)	7-8	Cooking	3-4
	Grilled	Preheating the pan	7-8	Grilling on both sides	7-8
	Browned	Browning with oil (if with butter power level 6)	7-8	Cooking	4-5
	Stewed	Browning with oil (if with butter power level 6)	7-8	Cooking	3-4
Fish	Grilled	Preheating the pan	7-8	Cooking	7-8
	Stewed	Browning with oil (if with butter power level 6)	7-8	Cooking	3-4
	Fried	Heating the oil or fat	8-9	Frying	7-8
Eggs	Frittata	Heating the pan with butter or fat	6	Cooking	6-7
	Omelettes	Heating the pan with butter or fat	6	Cooking	5-6
	Soft/hard-boiled	Heating the water	Booster - 9	Cooking	5-6
	Pancakes	Heating the pan with butter	6	Cooking	5-6
Sauces	Tomato	Browning with oil (if with butter power level 6)	6-7	Cooking	3-4
	Ragu	Browning with oil (if with butter power level 6)	6-7	Cooking	3-4
	Béchamel	Preparing the base (melt butter and flour)	5-6	Bring to a light boil	3-4
Desserts, creams	Pastry cream	Bring the milk to the boil	4-5	Maintain a light boil	4-5
	Puddings	Bring the milk to the boil	4-5	Maintain a light boil	2-3
	Rice in milk	Heat the milk	5-6	Cooking	2-3

5019 300 00334

