

Gebrauchsanweisung

Instructions for use

Mode d'emploi

Gebruiksaanwijzing

Istruzioni per l'uso



Brugsanvisning

Bruksanvisning

Käyttöohje

Manual de utilização

Instrucciones para el uso



Οδηγίες χρήσης

Instrukcje użytkowania

Használati utasítás

Инструкция за употреба

Navodila za uporabo

Upute za uporabu



Návod k použití

Návod na použitie

Instrucțiuni de utilizare

Инструкции по эксплуатации

Uputstvo za upotrebu

CONTENTS



READ INSTRUCTIONS FOR USE!

INSTRUCTIONS FOR USE

SAFE INSTALLATION AND USE	Page 3
INTENDED USE	Page 7
INSTALLATION	Page 8
DESCRIPTION OF THE DRYER	Page 9
CLEANING AND MAINTENANCE	Page 10
CLEANING THE LINT FILTER	Page 10
CLEANING THE HEAT EXCHANGER	Page 11
DRAINAGE SYSTEM	Page 12
DOOR REVERSIBILITY	Page 14
ENERGY SAVING/AUTOMATIC SWITCH-OFF FUNCTION	Page 15
TROUBLESHOOTING GUIDE/AFTER-SALES SERVICE	Page 16
DISPOSAL	Page 18

QUICK REFERENCE GUIDE

INDICATORS AND OPTIONS
PROGRAMME CHART
RUNNING A PROGRAMME
TROUBLESHOOTING / MAINTENANCE
CONSUMPTION DATA



SAFE INSTALLATION AND USE

To avoid injuries, damages on the dryer and its surrounding area or even a fire, you must observe the instructions below.

Packaging, damages, handling

- Keep the packaging foil away from children; danger of suffocation.
- Do not operate the dryer if it has been damaged during transport or later. Inform the After-Sales Service.
- If the dryer was exposed to the cold before delivery, keep it at room temperature for a few hours before installation. Cold temperatures can affect the proper functioning of electronic parts.
- Never lift your dryer by holding it on extruding parts (e.g. door) or on the worktop; parts might loosen or break and persons might get injured.
- For lifting the dryer, at least 2 persons are necessary, to avoid accidents.

Location and surrounding area

- The dryer is appropriate for indoor use only.
- Do not install the dryer in rooms with poor ventilation. If you want to install it in a small storage room, toilet, bathroom or similar, assure a good ventilation (open door, ventilation grid or slot larger than 500 cm²).
- Do not install the dryer where it will be exposed to extreme temperatures below 5°C or over 35°C, to avoid malfunction, damages to dryer parts or fire.
-  The dryer must be placed with the back towards a wall, to avoid injuries by touching the rear panel, which can become hot during the drying process.
- Do not store flammable fluids near the dryer, to prevent fires.
- Do not install the dryer behind a lockable door, a sliding door or a door with a hinge on the opposite side to the tumble dryer's door, in a way that a full opening of the dryer door is restricted.
- Do not install the dryer on a deep pile carpet, to avoid that the ventilation openings are clogged.
- Do not store flammable fluids near the dryer, to prevent fires.
- If you must install the dryer next to a gas or coal stove, you must fix a heat insulating plate (85 x 57 cm) between dryer and stove; the plate's side pointing towards the oven must be covered with aluminium foil, to protect the dryer against high temperatures.
- Built-in installation of the tumble dryer is not permitted.

- If you want to install the dryer under a worktop, make sure that a ventilation grid (minimum 45 x 8 cm) is inserted in the rear part of the worktop where the dryer will be installed, to assure sufficient ventilation.

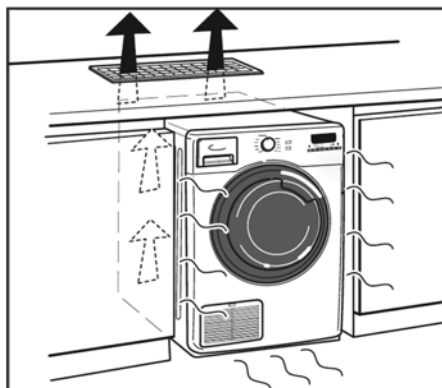

Stacking on a washing machine

- If you want to place the dryer on top of your washing machine, first contact our After-Sales Service or your specialist dealer to verify if this is possible. Stacking of a dryer is only admitted if the dryer and your washing machine are compatible, and if an appropriate stacking kit is available through our After-Sales Service or your specialist dealer by which the dryer can be safely fixed on the washing machine.



Electrical connection

- The dryer must only be connected to an earthed socket which is in compliance with the current safety regulations and which is appropriate for the values regarding voltage, power consumption and protection requirements as they are indicated on the rating plate on the rear of the dryer.
- Do not use extension leads, extension leads with multiple sockets, or adapters; they might cause a fire by overheating. If you need a longer mains cable, contact our After-Sales Service.
- After installation, access to the mains plug or to disconnection from mains supply by a double-pole switch must be ensured at all times, to make sure the dryer can be separated immediately from the mains supply.
- For unplugging the dryer, do not pull the mains cable, to avoid damaging it. Never touch the mains plug with wet hands, to avoid an electrical shock.

- Do not trap the mains cable between the dryer and the wall, to prevent damages on the cable.
- Do not operate the dryer if the mains cable or plug shows damages.
- Before doing any maintenance on the dryer, disconnect it from the mains supply, to avoid dangers.
- If necessary, the mains cable can be replaced; the replacement must only be done by our After-Sales Service or by a qualified technician, to avoid dangers.
- When using a residual current circuit breaker (RCCB), only use a model marked with 

Children and handicapped people

- Children must not play with the dryer
- Children younger than 3 years should be kept away from the dryer, unless they are continuously supervised.
- The dryer can be operated by children from the age of 8 years up, as well as by people with reduced physical, sensory or mental capabilities or lack of experience and knowledge, provided they are supervised or instructed regarding the safe use of the dryer and they understand the dangers resulting from the use.
- Care and maintenance works on the dryer must not be done by children without being supervised.
- Ensure that children and small animals cannot get into the drum.



Safe operation/minimizing the risk of a fire

- Do not tumble dry laundry containing oil, to prevent a fire. Oil-bearing items can ignite spontaneously, especially when they are exposed to heat sources as in a tumble dryer. The items would become warm, causing an oxidation reaction in the oil. Oxidation creates heat; if the heat cannot escape, the item can become hot enough to catch fire.
- Do not tumble dry unwashed laundry in the tumble dryer.
- Laundry items that have been soiled with substances such as cooking oil, acetone, alcohol, benzene, petroleum, kerosene, stain removers, turpentine, wax or wax removers must be washed in hot water, with an extra amount of detergent, before being dried in the tumble dryer.
- Items such as foam rubber (latex foam), shower caps, waterproof textiles, rubber backed articles and clothes or pillows fitted with foam rubber pads must not be dried in the tumble dryer.

- Remove all objects from pockets such as lighters and matches.
- Do not use flammable cleaning agents.
- Do not use the tumble dryer if chemicals have been used for cleaning.
- Fabric softeners or similar products must be used as specified by the fabric softener instructions.
- Never stop the tumble dryer before the end of the drying cycle, unless all items are quickly removed and spread out so that the heat is dissipated. The final phase of a drying cycle always occurs without heat (cool down phase), to ensure that the laundry items are left at a temperature which does not cause damage to the laundry.
- Clean the door filter after each drying cycle (see paragraph CLEANING THE DOOR FILTER).
- Keep the surrounding area of the dryer free from lint.
- Always set the programme knob to the Off-position "O" after programme end, to reduce the risk that the dryer might be started accidentally.
- Drying clothes with buckles or using dryer balls may impact the surface of the drum.

Maintenance

- Before doing any maintenance, switch off the dryer and disconnect it from the mains supply.
- Never use flammable fluids for cleaning the dryer.
- Do not use detergents containing solvents, scouring powder, glass or general purpose cleaners. They might harm the surfaces.

Repairs and spare parts

- Repairs must only be done by our After-Sales service. Improper repairing can lead to unpredictable dangers for the user and to damages on the dryer and will moreover cause the loss of the guarantee.
- For repairs, only original spare parts are admitted, to assure proper functioning of the dryer.
- For dryer models with drum light: Replacing the light bulb must only be carried out by our After-Sales Service.

INTENDED USE

This appliance is destined to dry laundry which is marked to be appropriate for being treated in a dryer, in quantities which are usual for private households.

- Observe the instructions given in these Instructions for Use and in the Quick Reference Guide when using the dryer.
- Keep these Instructions for Use and the Quick Reference Guide; if you pass on the dryer to another person, also give him/her Instructions for Use and Quick Reference Guide.

INSTALLATION

For installing your dryer, you must observe the instructions of chapter SAFE INSTALLATION AND USE.

- Carefully level the dryer by adjusting the four feet; check the correct leveling with a level.
- Before running the first drying cycle, ensure that the water container is fully pushed inside and that the bottom filter is correctly positioned (see chapter DESCRIPTION OF THE DRYER).
- Also make sure that all hoses of the drainage system are connected as shown in the picture below.

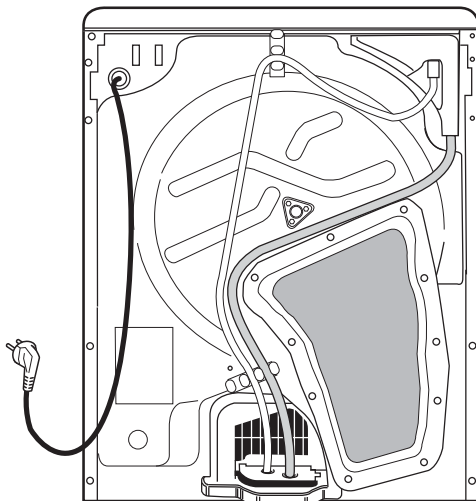

If possible you can drain the water directly into the domestic plumbing system. This will avoid having to empty the water container at the end of each drying cycle since the condensation water can be directly drained away (see chapter DRAINAGE SYSTEM).

Electrical connection for Great Britain/Ireland

1) For Great Britain only

Warning – this appliance must be earthed

Fuse replacement

If the mains lead of this appliance is fitted with a BS 1 363A 13 amp fused plug, to change a fuse in this type of plug use an A.S.T.A. approved fuse to BS 1 362 type and proceed as follows:

1. Remove the fuse cover (A) and fuse (B).
2. Fit replacement 13A fuse into fuse cover.
3. Reinstall both into plug.

Important:

The fuse cover must be reinstalled when changing a fuse and if the fuse cover is lost, plug must not be used until a correct replacement is installed.

Correct replacements are identified by the color insert or the color embossed in words on the base of the plug. Replacement fuse covers are available from your local electrical store.

2) For the Republic of Ireland only

The information given in respect of Great Britain will frequently apply, but a third type of plug and socket is also used, the 2-pin, side earth type.

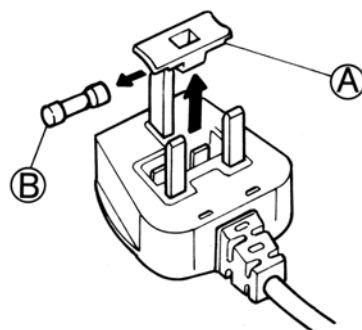

3) Socket outlet / plug (valid for both countries)

If the fitted plug is not suitable for your socket outlet, please contact Whirlpool Service for further instruction.

Please do not attempt to change plug yourself. This procedure needs to be carried out by a qualified Whirlpool technician in compliance with the manufactures instructions and current standard safety regulations.

DESCRIPTION OF THE DRYER

- A. Work top
- B. Water container

C. Contact pin

D. Door:

To open the door: pull the handle.

To close the door: push gently until closed.

E. Filter

F. Heat exchanger

G. Heat exchanger flap

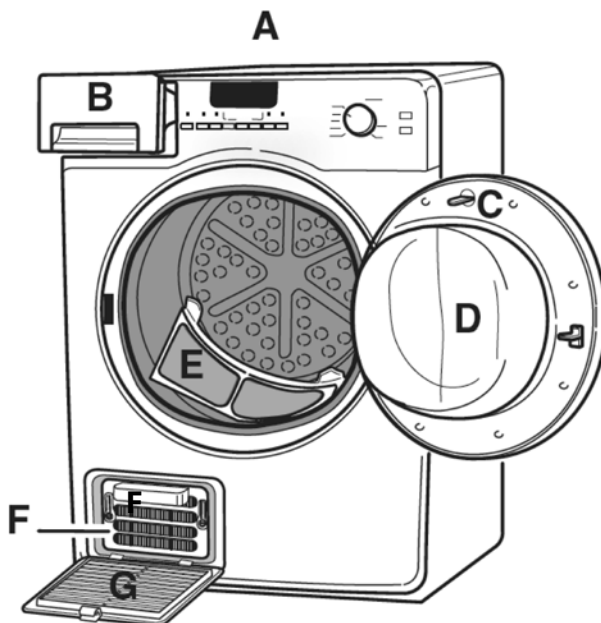

CLEANING AND MAINTENANCE

Before any cleaning or maintenance, switch off the dryer.

AFTER EACH DRYING CYCLE

- Clean the lint filter at the end of every drying cycle.
- Empty the water container at the end of each drying cycle.

EACH MONTH

- Clean the heat exchanger at least every month (see “Cleaning the heat exchanger” on the next page).

Cleaning the lint filter

Depending on the model of your dryer, the lint filter can have different shapes.

Clean the lint filter after every drying cycle, or when the lint filter indicator lamp lights up, proceeding as follows:

- Remove the completed laundry out of the dryer before removing the lint filter.
- Take the lint filter out of the dryer and carefully open the filter.
- Carefully remove the complete lint from the lint screen.
- If the mesh is clogged and cannot be cleaned by hand, run the filter under water and scrub with a soft brush.

When the lint filter is clean, put it back into the dryer. Make sure that the lint filter is correctly positioned before starting the next drying cycle.

NOTE:

Be aware that the lint filter is always correctly positioned when laundry is put into the drum or is taken out of it.

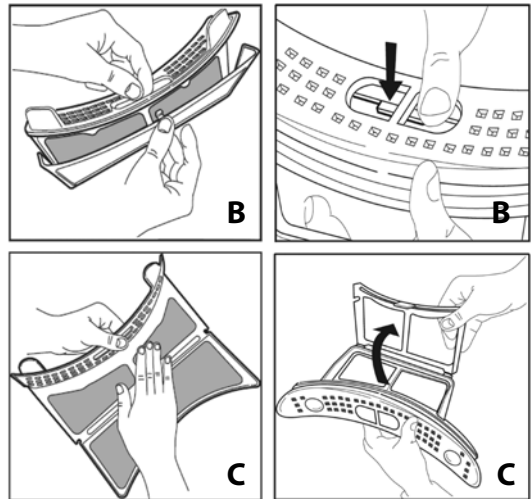

Cleaning the heat exchanger

Before any cleaning or maintenance, switch off the dryer.

Clean the heat exchanger at least every month, or whenever the heat exchanger indicator lamp lights up (if available on your model), proceeding as follows.

A. Open the heat exchanger flap.

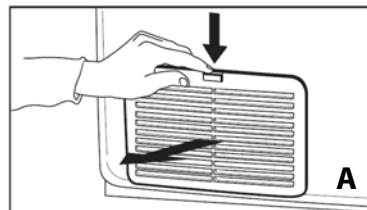

B. Turn the two locking bars at the side of the heat exchanger towards the middle, to the horizontal position, and pull the heat exchanger out.

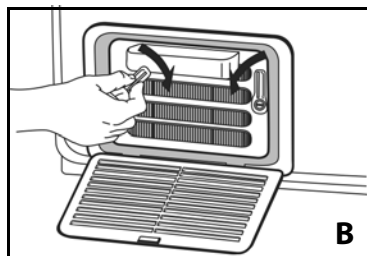

C. Hold the heat exchanger as shown in the picture. Clean it under running water by turning it around to reach all sides, especially in front and behind. Wipe away dust and lint from the heat exchanger seals and plates. Clean the inside of the heat exchanger plates under running water, from the front side to the back.

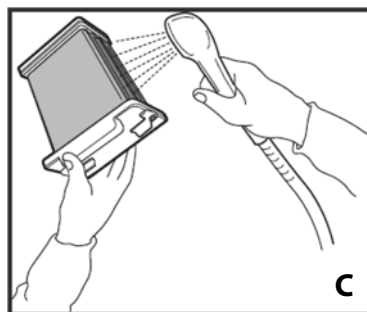

D. Remove the lint from the heat exchanger housing by hand or with a damp cloth. Clean the entire housing from the back to the front side, ensuring that all lint is removed.

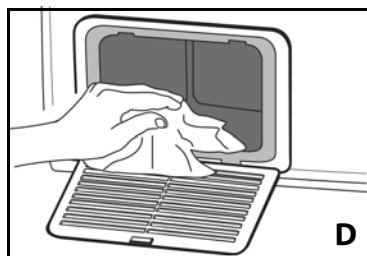

- Fully insert the heat exchanger back into the housing (TOP or HAUT mark upwards) and lock it again by turning the locking bars back to their original position.
- The heat exchanger does not need to be dry when it is reinserted after cleaning.
- Insert and latch the flap again. The flap can only be closed if the heat exchanger is correctly positioned.
- The heat exchanger indicator lamp will switch off automatically when you start the next drying cycle.

The heat exchanger aluminium plates may become discoloured over time, depending on the model of your dryer.

DRAINAGE SYSTEM

For your convenience:

The dryer can be connected directly to the sewage system of the house to avoid the emptying of the water container after each drying cycle.

Place an absorbent cloth underneath to collect water spillage.

- A.** Unplug the hose located at the upper rear part of the dryer.

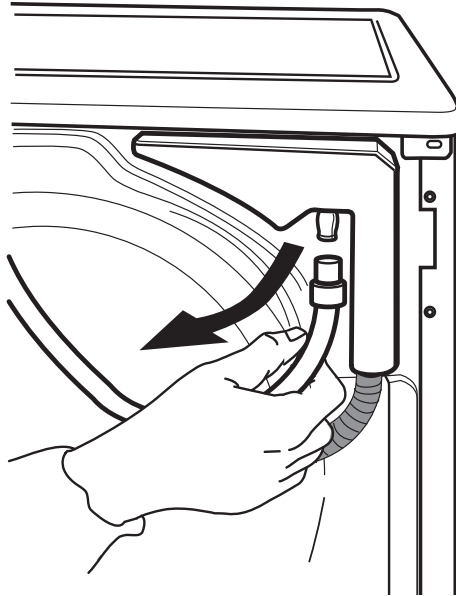

- B.** Remove the white hose from the hose fixation.

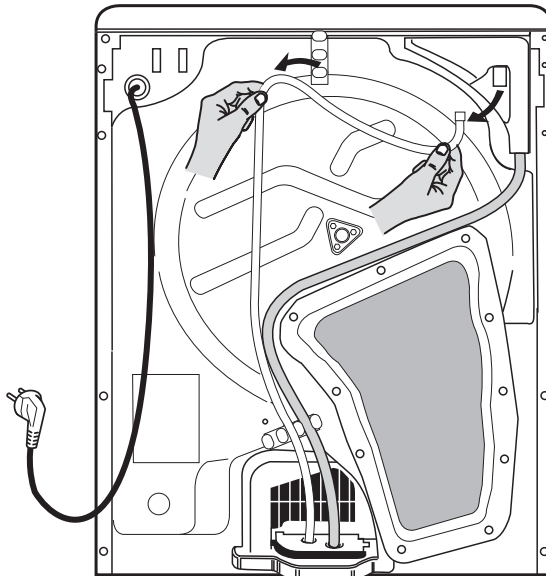

- C. Fix the hose to the sewage system. The height difference between the floor where the dryer stands on and the connection at the sewage system should not exceed 1 m.

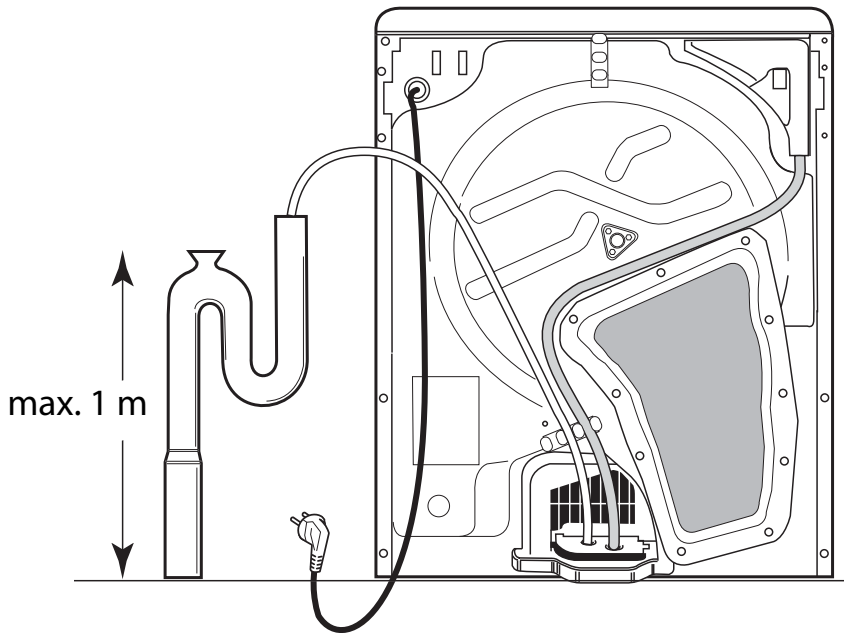

NOTE: To avoid siphoning, the end of the hose must not be immersed in the drain water. Avoid bending and twisting the hose.

DOOR REVERSIBILITY

For your convenience:

In case you want to stack the dryer on a washing machine, you can reverse the door opening direction, to lower the position of the door handle.

Unplug the dryer.

A. Open the door.

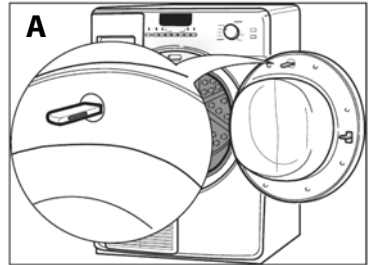

B. Using a spanner, turn the contact pin in the top part of the door through 90° and pull it out.

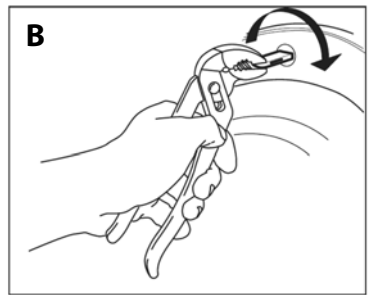

C. Removing the door lock:
Unscrew the 2 screws above and below the door lock system.

D. Press the small knob above the door lock system with a small screwdriver, move the door lock a little bit upwards and pull the door lock towards you with your finger.

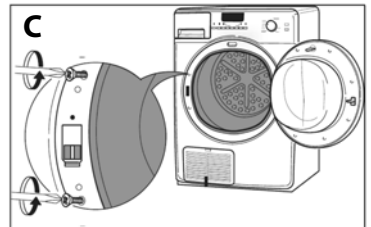

E. Reverse the door:
Remove the two screws of the door fixing plate.
Fasten the door again on the desired side with the 2 screws.
Take care to tighten the screws horizontally to avoid pinching off the door.

Repositioning of the door lock:

Insert the door lock on the opposite side of the door fixing plate.

Press it fully into the hole and move it downwards slightly, until the small knob of the door lock system latches in position.

Fasten the two screws above and below the door lock system.
Now re-insert the contact pin on the inside of the door, at the top, by inserting it and turning it again through 90°.

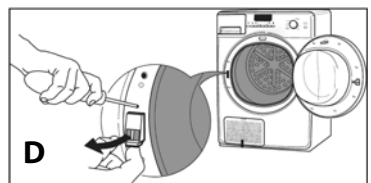

NOTE:

Use a Torx T20 type screwdriver to undo and tighten the screws.

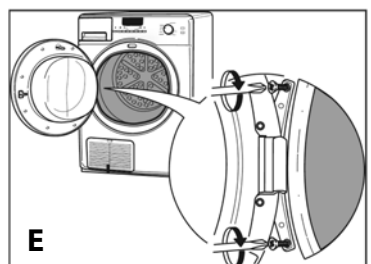

ENERGY SAVING

For Dryers with Energy Label according to Directive 2010/30/EU

The Energy Label contains information on performance and consumption of your dryer:

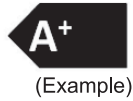

The bold black arrow marks the energy efficiency class (A+++ = most efficient / D = least efficient).



Power consumption per year



Type of dryer



Maximum load capacity



Drying time



Noise level drying



Condensation efficiency

Automatic switch-off function

Your dryer is designed to save energy. For that reason, the dryer will switch off automatically a short time after programme end.

When a programme is selected but not yet started, the dryer will switch off after a few minutes.

To switch the dryer on again, turn the programme selector to "Off / O" and afterwards to the desired programme again.

Energy saving tips

- The programme which is the most energy-efficient for drying normal wet cotton laundry is specified in the separate Quick Reference Guide; it is the reference programme for the Energy Label.
- Your dryer is designed to save energy. After the end of a programme the dryer will therefore switch off after a short time. When a programme is selected but not yet started, the dryer will switch off after a few minutes.

- Always dry a full load: depending on the type of laundry and the programme/drying time. For detailed information, refer to the separate Quick Reference Guide.
- Use the maximum spin speed allowed by your washing machine, since draining the water mechanically requires less energy. You will save time and energy when running your drying cycle.
- Do not overdry the laundry.
- Clean the door filter after every drying cycle.
- Clean the bottom filter after every fifth drying cycle.
- Place your dryer in a room with a temperature between 15 °C and 20 °C. In case of higher temperature, ventilate the room, e.g. open the window.
- Always select the correct programme/ drying time for the load in order to obtain the desired drying results.
- Select the gentle option only with small loads.
- When drying cotton, dry iron dry and cupboard dry loads together. Start with the iron dry programme/drying time setting, remove the laundry to be ironed at the end of that cycle and dry the remainder of the load on the cupboard dry setting.

TROUBLESHOOTING GUIDE/AFTER-SALES SERVICE

If a fault occurs, before contacting our After-Sales Service, perform the following checks to try to remedy the problem:

Drying takes too long / laundry is not dry enough:

- Correct programme selected?
- Inserted laundry too wet (Washing machine spin speed less than 800 rpm? When the spinning speed is less than 800 rpm the water container fault may occur during the drying cycle)?
- Door filter clogged (filter indicator lamp on)?
- Heat exchanger clogged? (refer to the sections "CLEANING THE LINT FILTER/CLEANING THE HEAT EXCHANGER").
- Is the ambient temperature too high?
- END indicator lamps on? The drying cycle is complete and the laundry can be taken out.
- 'Gentle' option selected? The 'gentle' option should only be selected with small loads.
- Mixed laundry load (for example cotton and synthetics)?

The dryer does not operate:

(after a power failure and/or interruption to the mains supply, always press the Start/Pause button).

- Dryer automatically switched off for energy saving? See paragraph "Automatic switch-off function".
- Plug connector properly inserted into the mains electricity socket?
- Power failure?
- Fuse blown?
- Door properly closed?
- Drying programme selected?
- Start delay option selected?
- Start/Pause button activated?
- Indicator lamps are lighting up?

Lint filter, water container or heat exchanger indicator lamp on:

- Lint filter clean?
- Water container empty?
- Water container correctly positioned?
- Heat exchanger clean and correctly positioned?

Water droplets underneath the dryer:

- Heat exchanger correctly positioned?
- All lint on the heat exchanger seal removed?
- Any lint on the door seal removed?
- Water container positioned correctly?
- Dryer levelled?

After-Sales Service

If, after carrying out the above checks the malfunction persists or appears again, turn the dryer off and call the After-Sales Service (refer to guarantee).

Please indicate:

- The nature of the fault.
- The dryer type and model.
- The service code (the number after the word Service on the adhesive rating plate) on the lower side of the door opening.
- Your full address and phone number.

SERVICE 0000 000 00000



**Manufacturer:
Whirlpool Europe s.r.l.
Viale Guido Borghi 27
21025 Comerio (VA)
Italy**

EC Declaration of Conformity

- This dryer has been designed, constructed and distributed in compliance with the safety requirements of EC Directives:
- 2006/95/EC Low Voltage Directive.
- 2004/108/EC Electromagnetic Compatibility Directive.



DISPOSAL

- This appliance is marked according to the European directive 2002/96/EC on Waste Electrical and Electronic Equipment (WEEE).
- By ensuring this product is disposed of correctly, you will help prevent potential negative consequences for the environment and human health, which could otherwise be caused by inappropriate waste handling of this product.



Packing

- The packing box is 100% recyclable, as confirmed by the recycling symbol.

Disposing of packaging and old appliances:

- The dryer is built from reusable materials. The dryer must be disposed of in compliance with local waste disposal regulations.
- Before disposing, cut off the power cable so that the dryer cannot be connected to the mains.
- The symbol  on the product or on the documents accompanying the product indicates that this appliance may not be treated as household waste. Instead it shall be handed over to the applicable collection point for the recycling of electrical and electronic equipment. Disposal must be carried out in accordance with local environmental regulations for waste disposal.
- For more detailed information about treatment, recovery and recycling of this product please contact your local city office, your household waste disposal service or the shop where you purchased the product.