

DAILY REFERENCE GUIDE



THANK YOU FOR PURCHASING A WHIRLPOOL PRODUCT

To receive more comprehensive help and support, please register your product at www.whirlpool.eu/register



You can download the Safety Instructions and the Use and Care Guide by visiting our website docs.whirlpool.eu and following the instructions on the back of this booklet.



Before using the appliance carefully read the Health and Safety guide.

PRODUCT DESCRIPTION

APPLIANCE

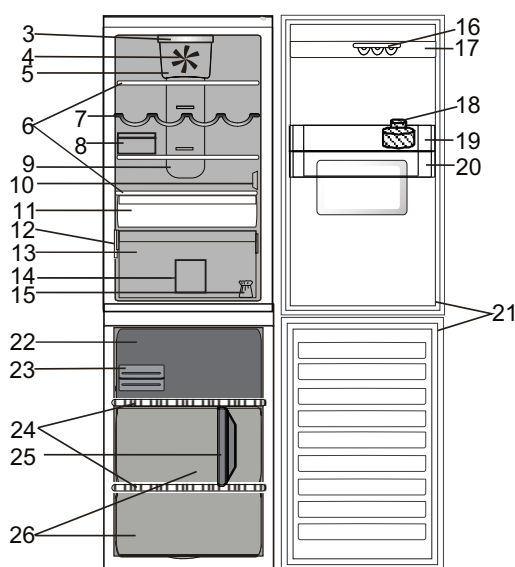

- | | |
|--|--|
| 1. Control panel | 14. Fridge drawer divider |
| Refrigerator compartment | 15. Door reversibility kit |
| 2. Dispenser's paddle | 16. Egg tray |
| 3. LED lighting | 17. Door tray |
| 4. Fan | 18. Water filter |
| 5. Fan cover and antibacterial filter area | 19. Aqua balcony |
| 6. Shelves | 20. Aqua tank |
| 7. Bottle rack | 21. Door seal |
| 8. Cheese box + Lid | Freezer compartment |
| 9. Multi-flow cold air area | 21. Door seal |
| 10. Sensor cover | 22. Upper drawer: coolest zone best for freezing fresh food |
| 11. Cooler compartment (best for meat and fish) | 23. Quick Ice / Eutetics |
| 12. Rating plate with commercial name | 24. Shelves |
| 13. Fruits and vegetables crisper | 25. Freezer drawer divider |
| | 26. Freezer drawers |

CONTROL PANEL

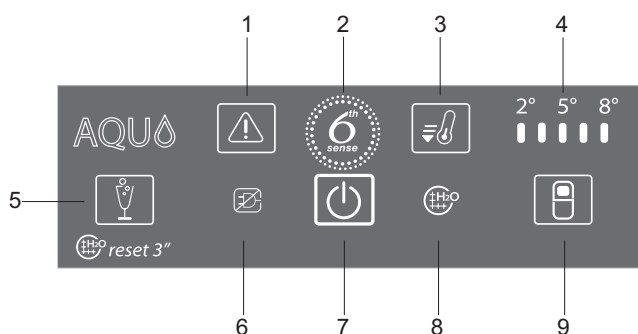

- | |
|--|
| 1. STOP ALARM button /ALARM indicator |
| 2. 6th SENSE FRESH CONTROL indicator |
| 3. FAST COOL button |
| 4. FRIDGE TEMPERATURE LEDs |
| 5. PARTY MODE button /WATER FILTER button |
| 6. BLACK OUT ALARM |
| 7. ON/STAND-BY button |
| 8. WATER FILTER indicator |
| 9. FRIDGE TEMPERATURE button |

ACCESSORIES

EGG TRAY

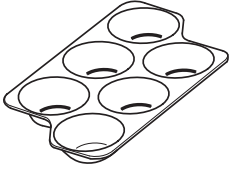

CHEESE BOX



BOTTLE RACK

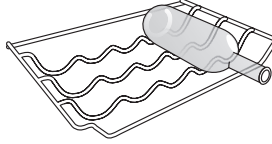

BOTTLE SEPARATOR

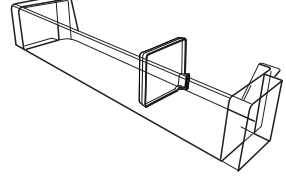

FREEZER DRAWER DIVIDER

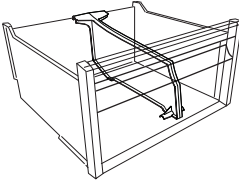

FRIDGE DRAWER DIVIDER

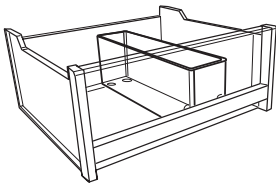

QUICK ICE COMPARTMENT

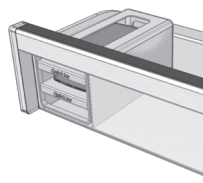

EUTETICS/QUICK ICE TRAYS

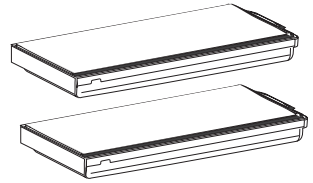

FIRST TIME USE

HOW TO START THE APPLIANCE

After plugging the appliance to the mains, it starts the operation automatically.
After starting the appliance, wait at least 4-6 hours before placing food into the fridge and into the freezer compartment.

When the appliance is connected to the power supply, the display lights up and all the icons appear on the display for approximately 1 second. The default (factory) values of the fridge compartment settings light-up.

QUICK ICE

HOW TO MAKE ICE CUBES

Put the empty ice cube trays into the freezer 24 hours before using the Quick Ice feature to cool them down. To achieve the best performance of the Quick Ice trays it is recommended to keep them permanently in the freezer and maintain temperature setting at -18°C or colder.
Remove a Quick Ice tray by pulling it towards you.

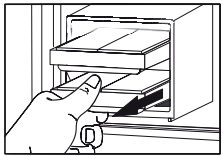





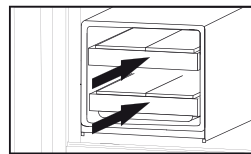









Remove the cover and fill the tray with potable water (maximum level = $\frac{2}{3}$ of the overall capacity of the tray).

Insert the cover back into the tray and insert it back into the dedicated slots in the top freezer drawer. Take care not to spill water.



Wait at least 30 minutes until the ice cubes are formed (this time can be slightly longer if the trays are used immediately after the first use).

ALARM TABLE

ALARM TYPE	Signal	Cause	Cure
Door open alarm 	The acoustical alarm is activated and the Alarm Indicator  blinks.	The Fridge or Freezer door has remained open for more than 2 minutes.	Close the door or press the Stop Alarm button  to mute the acoustical alarm.
Temperature alarm 	The acoustical alarm is activated and the Alarm Indicator  remains on.	Inside the Freezer the temperature is not adequate	Press the Stop Alarm button  ; the acoustical alarm stops, the Alarm Indicator  remains on until a temperature < -10°C is reached.
Party Mode alarm 	The Party Mode Indicator  blinks and the acoustical alarm is activated.	30 min. elapsed since Party Mode function has been activated. It is time to take out the bottle from the freezer (see Use and Care Guide for more details).	Press the Party Mode button to stop the alarm.
Long black-out alarm 	The Black Out Alarm icon remains on, the Alarm indicator  blinks.	Prolonged power failure, able to cause the inside temperature to increase to 0°C.	Press the Stop Alarm button  ; the acoustical alarm stops.
Water filter alarm 	The Water filter alarm indicator  lit on.	Finished the validity of Water filter.	Replace the Water filter, press and hold for 3 sec. the Party Mode button  to reset it.
Malfunction	3 central LEDs in the Fridge Temperature LEDs blinks on the display.	Product malfunction.	Contact the After-sales Service.

FUNCTIONS

ON/STANDBY FUNCTION

To put the product in Stand-by, **press and hold the On/Stand By button for 3 seconds**. All the indicators turn off except On/Standby indicator.

Press again to reactivate the appliance.

SMART DISPLAY

This optional function can be used to save energy. To activate the Smart Display, press Fridge Temperature and Party Mode buttons at the same time for 3 seconds until an audible signal sounds. To deactivate this function repeat the same procedure. Remember that this function does not disconnect the appliance from the power supply, but only reduce the power consumed by external display.

TEMPERATURE SETTING

To adjust the Fridge Temperature, press the Fridge Temperature button. The Fridge Temperature can be adjusted between +2°C and + 8°C, as shown by the Fridge Temperature LEDs.

PARTY MODE

Press to activate/deactivate the Party Mode function. Use this function to chill drinks inside the freezer compartment.

Important: do not leave the bottle inside the freezer compartment longer than the function is active (30 minutes)

6TH SENSE FRESH CONTROL

This function automatically works to ensure the optimal conditions to preserve the stored food. If there are any variations, 6th Sense Fresh Control immediately restores the ideal conditions. Results are outstanding: freshness preserved at best throughout the fridge cavity up to 4 times longer.

FAST COOL

Using Fast Cool function it is possible to increase the cooling in the refrigerator compartment. The use of this function is recommended when placing a very high quantity of food in the refrigerator compartment. Press the Fast Cool button to activate Fast Cool function. When activated, the Fast Cool indicator will turn on. The function is automatically disabled after 6 hours, or can be manually disabled by pressing Fast Cool button.

REFRIGERATOR LIGHT

The light system inside the refrigerator compartment uses LEDs light, allowing a better lightning as well as a very low energy consumption.

If the LED light system does not work, please contact the Service to replace it.

Important: The refrigerator compartment light switches on when the refrigerator door is opened. If the door is kept open for more then 10 minutes the light will be automatically switched off.

FAN + ANTIBACTERIAL FILTER

The Fan improves temperature distribution inside the refrigerator compartment, allowing better preservation of stored food.

If the appliance has the Fan can be equipped with the antibacterial filter.

Remove it from the box placed in the crisper drawer and insert into the fan cover - as in the picture.

The replacement procedure is included in the filter box.

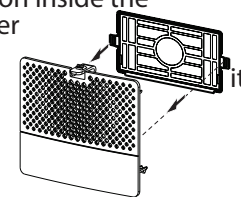

INSTALLATION OF THE WATER FILTER (ACTIVE CARBON)

The water filter is located inside the tank. This filter reduces the amount of chlorine, sediment, dirt, rust and cloudiness in the drinking water in the container located inside the tank. The filter must be installed in bottle balcony following the instructions contained in the water filter box. The filter is removable.

WATER FILTER

The water filter use an active carbon cartridge that reduces the amount of chlorine, sediments, dirt, rust and cloudiness in the drinking water.

The filter must be installed in the bottle balcony. It is removable.

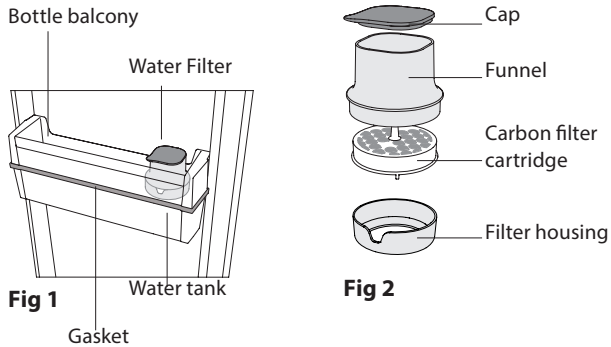

CARBON CARTRIDGE ACTIVATION

Before to use filter, the CARBON FILTER CARTRIDGE must be activated and installed. Remove the carbon filter from the packaging (which you can find in fruits and vegetables crisper) and activate it in this way;

1. submerge underwater for 10 minutes
2. remove it from water and shake it vigorously for 10 seconds to activate

FILTER INSTALLATION

Remove filter from balcony and open it to insert the carbon cartridge:

- Unlock the whole filter turning it anticlockwise (Fig 3)

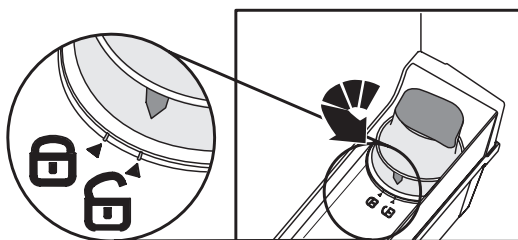

Remove the filter from the balcony (Fig. 4)

- Remove the funnel from the filter housing rotating it anticlockwise (Fig 5. a - b).

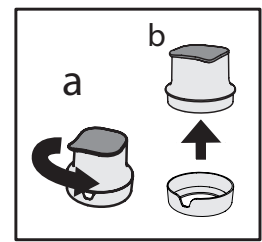
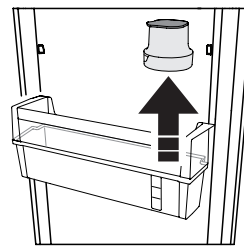

After activated, insert the carbon cartridge in the filter housing with the current month facing through the window (eg. If you are in october, face Oct month in the window) - See Fig. 6

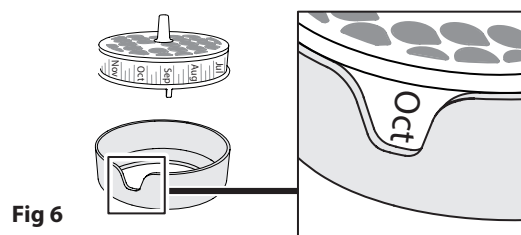

Close the filter (Fig. 7):

- a. insert the funnel on filter housing (with carbon filter in), as shown in Fig. 7a.
- b. rotate the funnel clockwise to fix it, as shown in Fig. 7b.

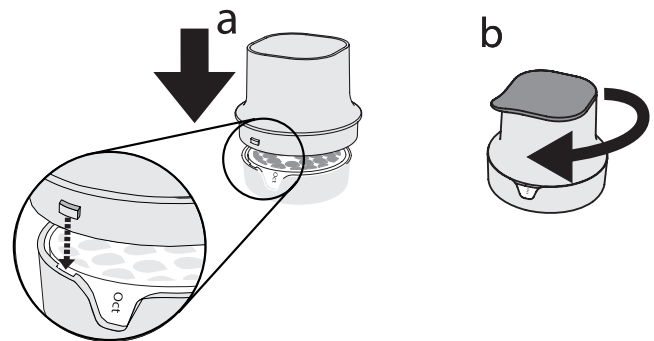

Then place the whole filter in the bottle balcony and lock it following the sequence in Fig 8.

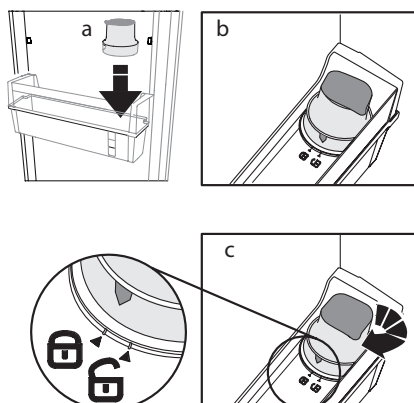

Fig 8

FILLING AND FILTERING WATER

Remove the cap and pour water into the funnel (Fig. 9): the water fill will be filtered and will fill the water tank. You can fill up to 3 litres. Don't overflow water (the max water level is indicated on the tank).

Note: fill water only in the tank. Do not insert juice, coke or other drink because they can damage the filter and the dispenser functionality.

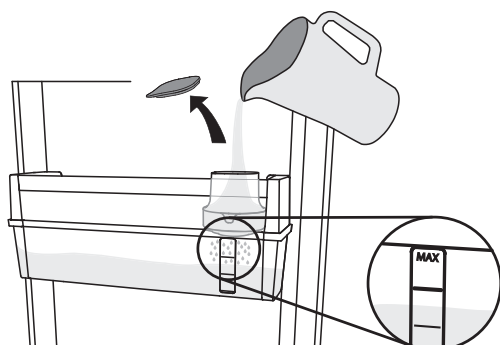

Fig 9

DISPENSING WATER

To dispense water press the paddle with a glass (Fig. 10) and release the paddle to stop dispensing.

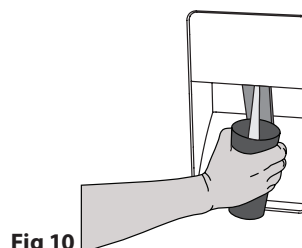

Fig 10



Fig 11

Note: possible black dots in the filtered water or in filter area are normal and not dangerous, they are due the normal carbon filter functionality.

DISPENSER CHILD LOCK: You can lock the dispenser's paddle to avoid children dispensing water (flip the small lever behind the paddle as shown in (Fig. 11))

REPLACING THE CARBON CARTRIDGE

The carbon filter lasts max 2 months for continuous use (up to 225 lt).

To replace the carbon cartridge:

- unlock the filter and remove it from the balcony;
- remove the funnel from filter housing rotating it anticlockwise;
- remove the old carbon cartridge and insert the new one after activated, with current month faced in the window).

(You can follow the procedure described in Carbon filter activation and Filter installation - Fig. 3, 4, 5, 6, 7, 8).

CLEAN THE TANK

It is suggested to periodically remove the tank to clean it (see Fig 12 and description below)

- unlock the filter (a) and remove it (b);
- remove the bottle balcony (c) then remove the tank (d) and the gasket.

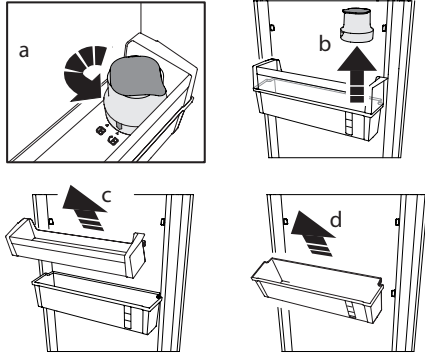

Fig 12

In case you decide to remove completely the water filter and tank from your fridge, you can remove the whole filter and the tank, using the balcony to normally store water bottles. In this case please use the filter cap to cover the hole on the balcony (see Fig. 13).

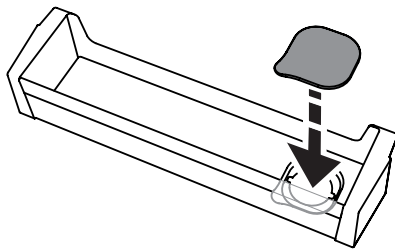

Fig 13

Wash the tank and the gasket with water only. At the end of cleaning, mount the gasket on the water tank. Make sure to correctly assembly the gasket on the tank (see Fig. 14).

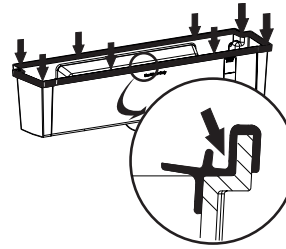

Fig 14

Then mount the bottle balcony on the water tank and assembly them on the door as suggested in Fig 15. Once assembled, mount the filter with the carbon cartridge (as described in Fig 5, 6, 7, 8).

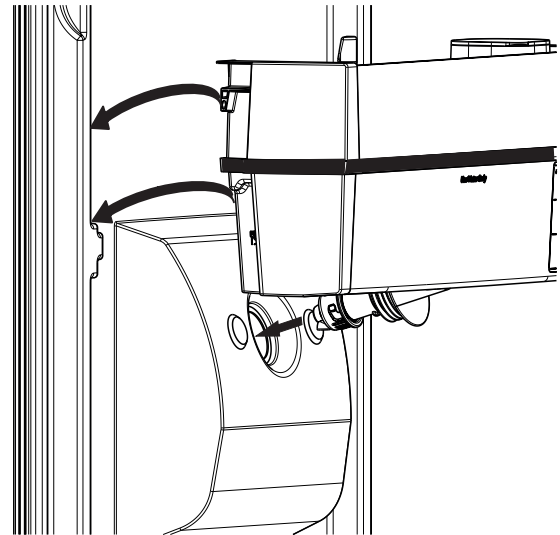

Fig 15

TROUBLESHOOTING GUIDE

<i>Problem</i>	<i>Possible Cause</i>	<i>Solution</i>
THE MOTOR SEEMS TO RUN TOO MUCH	Motor running time depends on different things: number of door openings, amount of food stored, temperature of the room, setting of the temperature controls.	<ul style="list-style-type: none"> › Make sure that the appliance controls are correctly set. › Check if there is not a large amount of food been added to the appliance. › Check that the door is not opened too often. › Check that the door close properly.
THE APPLIANCE TEMPERATURE IS TOO HIGH	There could be various causes (see "Solutions")	<ul style="list-style-type: none"> › Make sure that the condenser (back the appliance) is free of dust and fluff. › Make sure that the door properly closed. › Make sure that the door seals properly fitted. › On hot days or if the room is warm, the motor naturally runs longer. › If the appliance door has been left open for a while or if large amounts of food have been stored, the motor will run longer in order to cool down the interior of the appliance.
THE DOORS DO NOT OPEN AND CLOSE PROPERLY	There could be various causes (see "Solutions")	<ul style="list-style-type: none"> › Check that food packages are not blocking the door. › Check that the internal parts or automatic ice maker are not out of position. › Check that the door seals are not dirty or sticky. › Ensure the appliance is level.

SOME OF THE FUNCTIONAL SOUNDS YOU MIGHT HEAR

A hissing sound when switching on the appliance for the first time or after a long pause.



A gurgling sound when refrigerant fluid enters into the pipes.



BRRR sound is from the compressor running.



Buzzing sound when water valve or fan start working.



A cracking sound when compressor starts.



The CLICK is from the thermostat which adjusts how often the compressor is running.



HOW TO STORE FOOD AND BEVERAGE

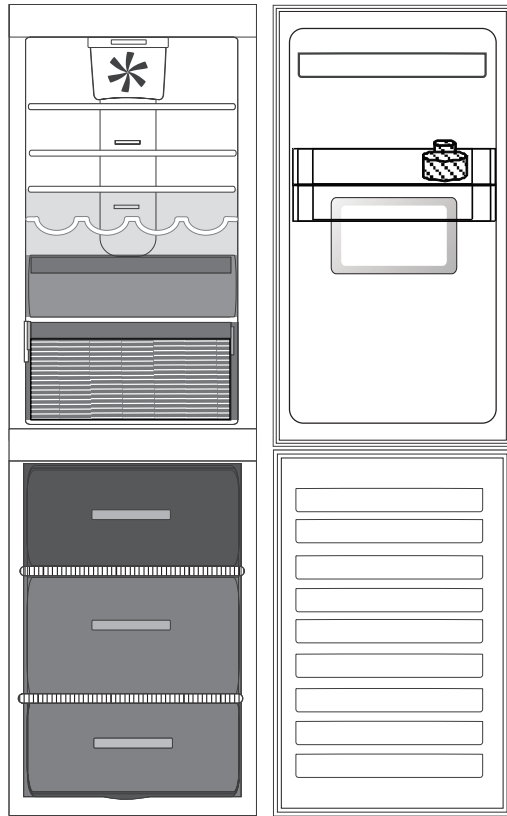

Legend



TEMPERATE ZONE

Suggested for the storage of tropical fruit, cans, drinks, eggs, sauces, pickles, butter, jam



COOL ZONE

Suggested for storage of cheese, milk, dairy food, delicatessen, yogurt



COOLEST ZONE

Suggested for the storage of cold cuts, desserts

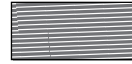

FRUIT & VEGETABLE DRAWER



FREEZING ZONE DRAWER

(MAX COOL ZONE) Suggested to freeze fresh/cooked food.



FREEZER DRAWERS

Note: The Grey tone of the legend doesn't match with the color of drawers

FRIDGE COMPARTMENT

Use recyclable plastic, metal, aluminum and glass containers and cling film to wrap foods.

Always use closed containers for liquids and for food that may give off or be tainted by odor or flavor transfer or cover them.

If you have a little quantity of food to store in the refrigerator, we recommend to use the shelves above the crisper for fruits and vegetables since this is the coolest area of the compartment.

Foods which give off a large amount ethylene gas and those that are sensitive to this gas, such as fruit, vegetables and salad, should always be separated or wrapped so as not to reduce the storage life; for example do not store tomatoes together with kiwi fruits or cabbage.

To avoid bottles falling over, you can use the bottle holder (available on selected models).

Do not store food too close together to enable sufficient air circulation.

FREEZER COMPARTMENT

The freezer is the ideal storage location for store frozen food, make ice cubes and freeze fresh food in the freezer compartment.

The maximum number of kilograms of fresh food that can be frozen within a 24-hour period is indicated on the rating plate (...kg/24h).

If you have a little quantity of food to store in the freezer, we recommend to use the coldest areas of your freezer compartment, corresponding to the upper area.

PRODUCT FICHE

[www](http://www.docs.whirlpool.eu) The product fiche with energy data of this appliance can be downloaded from Whirlpool website docs.whirlpool.eu

HOW TO OBTAIN THE USE AND CARE GUIDE

> [www](http://www.docs.whirlpool.eu) Download the Use and Care Guide from our website docs.whirlpool.eu (you can use this QR Code), specifying the product's commercial code.



> Alternatively, contact our Client After-sales Service.

CONTACTING OUR AFTER-SALES SERVICE

You can find our contact details in the warranty manual. When contacting our Client After-sales Service, please state the codes provided on your product's identification plate.

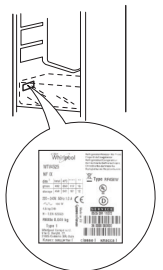

400010895980

Printed in Italy