

(Apply the label from warranty here)

SERVICE

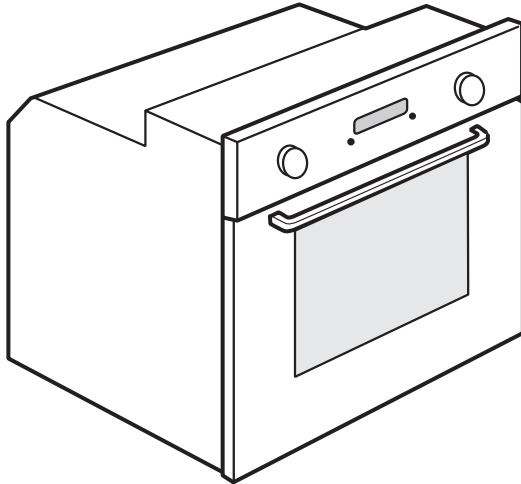

0000 000 00000



EN

User and maintenance manual

DE

Benutzer- und Wartungshandbuch

FR

Manuel d'utilisation et d'entretien

NL

Handleiding voor gebruik en onderhoud

EL

Εγχειρίδιο χρήσης και συντήρησης

IMPORTANT SAFETY INSTRUCTIONS

YOUR SAFETY AND THAT OF OTHERS IS VERY IMPORTANT

This manual and the appliance itself provide important safety warnings, to be read and observed at all times.



This is the danger symbol, pertaining to safety, which alerts users to potential risks to themselves and others.

All safety warnings are preceded by the danger symbol and the following terms:



Indicates a hazardous situation which, if not avoided, will cause serious injury.



Indicates a hazardous situation which, if not avoided, could cause serious injury.

All safety warnings give specific details of the potential risk present and indicate how to reduce risk of injury, damage and electric shock resulting from improper use of the appliance. Carefully observe the following instructions:

- The appliance must be disconnected from the power supply before carrying out any installation work.
- Installation and maintenance must be carried out by a qualified technician, in compliance with the manufacturer's instructions and local safety regulations. Do not repair or replace any part of the appliance unless specifically stated in the user manual.
- Regulations require that the appliance is earthed.
- The power cable must be long enough for connecting the appliance, once fitted in its housing, to the power supply socket.
- For installation to comply with current safety regulations, an all-pole disconnect switch with minimum contact gap of 3 mm must be utilized.
- Do not use multiple plug adapters or extension leads.
- Do not pull the power supply cable in order to unplug the appliance.
- The electrical components must not be accessible to the user after installation.
- Do not touch the appliance with any wet part of the body and do not operate it when barefoot.
- This appliance is designed solely for use as a domestic appliance for cooking food. No other type of use is permitted (e.g.: heating rooms). The Manufacturer declines all responsibility for inappropriate use or incorrect setting of the controls.
- The appliance is not intended for use by persons (including children) with any physical, sensory or mental impairment, or without experience and knowledge of the appliance, unless supervised or previously instructed in its use by those responsible for their safety.
- The accessible parts of the appliance may become very hot during use. Young children should be kept away from the appliance and supervised to ensure that they do not play with it.
- During and after use, do not touch the heating elements or interior surfaces of the appliance - risk of burns. Do not allow the appliance to come into contact with cloths or other flammable materials until all the components have cooled sufficiently.
- At the end of cooking, exercise caution when opening the appliance door, letting the hot air or steam exit gradually before accessing the oven. When the appliance door is shut, hot air is vented from the aperture above the control panel. Do not obstruct the vent apertures.
- Use oven gloves to remove pans and accessories, taking care not to touch the heating elements.
- Do not place flammable materials in or near the appliance: a fire may break out if the appliance is inadvertently switched on.
- Do not heat or cook sealed jars or containers in the appliance. The pressure that builds up inside might cause the jar to explode, damaging the appliance.
- Do not use containers made of synthetic materials.
- Overheated oils and fats catch fire easily. Always remain vigilant when cooking foods rich in fat and oil.
- Never leave the appliance unattended during food drying.
- If alcoholic beverages are used when cooking foods (e.g. rum, cognac, wine), remember that alcohol evaporates at high temperatures. As a result, there is a risk that vapours released by the alcohol may catch fire upon coming into contact with the electrical heating element.

Scrapping of household appliances

- This appliance is manufactured with recyclable or reusable materials. Dispose of it in accordance with local waste disposal regulations. Before scrapping, cut off the power supply cable.
- For further information on the treatment, recovery and recycling of household electrical appliances, contact your competent local authority, the collection service for household waste or the store where you purchased the appliance.

INSTALLATION

After unpacking the oven, be sure that it has not been damaged during transport and that the oven door closes properly. In the event of problems, contact the dealer or your nearest After-sales Service. To avoid any damage, only remove the oven from its polystyrene foam base at the time of installation.

PREPARING THE HOUSING UNIT

- Kitchen units in contact with the oven must be heat resistant (min 90°C).
- Carry out all cabinet cutting work before fitting the oven in the housing and carefully remove all wood chips and sawdust.
- After installation, the bottom of the oven must no longer be accessible.
- For correct appliance operation, do not obstruct the minimum gap between the worktop and the upper edge of the oven.

ELECTRICAL CONNECTION

Be sure the power voltage specified on the appliance dataplate is the same as the mains voltage. The dataplate is on the front edge of the oven (visible when the door is open).

- Power cable replacement (cable type indicated on the connection label) must be carried out by a qualified electrician. Contact an authorized service centre.

INTERCONNECTING HOB AND OVEN

IMPORTANT: do not connect the oven to the power supply before you have finished connecting the oven and hob. Before connecting the oven to the power supply, be sure that the hob is among the ones listed in the hob/oven pairing product sheet provided. Connect the hob connectors to the oven connectors as shown in the Installation Instruction, be sure that you match the colours and that the connector slots are aligned. Insert the connectors and push them in until they click into place. Unscrew the nut of the ground screw  located on the top covering of the oven and insert the yellow/green earth wire, leaving the washer in place. Firmly retighten the nut of the ground screw.

IMPORTANT: if the hob terminals do not match the connection and colours of the sockets on the oven, require the adapter kit, code AMC 873, available from After Sales Service.

GENERAL RECOMMENDATIONS

Before use:

- Remove cardboard protection pieces, protective film and adhesive labels from accessories.
- Remove the accessories from the oven and heat it at 200° for about an hour to eliminate the smell and fumes from the insulating materials and protective grease.

During use:

- Do not place heavy objects on the door as they could damage it.
- Do not cling to the door or hang anything from the handle.
- Do not cover the inside of the oven with aluminium foil.
- Do not pour water into the inside of a hot oven; this could damage the enamel coating.
- Do not drag pots or pans across the bottom of the oven as this could damage the enamel coating.
- Be sure that the electrical cables of other appliances do not touch hot parts of the oven or become trapped in the door.
- Do not expose the oven to atmospheric agents.

SAFEGUARDING THE ENVIRONMENT

Disposal of packing material

The packing material is 100% recyclable and is marked with the recycle symbol . The various parts of the packing must therefore be disposed of responsibly and in full compliance with local authority regulations governing waste disposal.

Scrapping the product

- This appliance is marked in compliance with European Directive 2002/96/EC, Waste Electrical and Electronic Equipment (WEEE).
- By ensuring this product is disposed of correctly, you will help avoid potential negative consequences for the environment and human health, which could otherwise be caused by inappropriate waste handling of this product.
- The symbol  on the product or on the accompanying documentation indicates that it should not be treated as domestic waste but must be taken to an appropriate collection centre for the recycling of electrical and electronic equipment.

Energy saving

- Only pre-heat the oven if specified in the cooking table or your recipe.
- Use dark lacquered or enamelled baking moulds as they absorb heat far better.
- Switch the oven off 10/15 minutes before the set cooking time. Food requiring prolonged cooking will continue to cook even once the oven is switched off.

DECLARATION OF CONFORMITY

- This oven, which is intended to come into contact with foodstuffs, complies with European Regulation () n.1935/2004 and has been designed, manufactured and sold in conformity with the safety requirements of the "Low Voltage" directive 2006/95/CE (which replaces 73/23/CEE and subsequent amendments), the protection requirements of "EMC" 2004/108/CE.

TROUBLESHOOTING GUIDE

The oven does not work:

- Check for the presence of mains electrical power and if the oven is connected to the electrical supply.
- Turn off the oven and restart it to see if the fault persists.

The door will not open:

- Turn off the oven and restart it to see if the fault persists.
- **Important:** during self-cleaning, the oven door will not open. Wait until it unlocks automatically (see paragraph "Cleaning cycle of ovens with pyrolysis function").

The electronic programmer does not work:

- If the display shows the letter "F" followed by a number, contact your nearest After-sales Service. Specify in this case the number that follows the letter "F".

AFTER-SALES SERVICE

Before calling the After-Sales Service:

1. See if you can solve the problem yourself with the help of the suggestions given in the "Troubleshooting guide".
2. Switch the appliance off and back on again it to see if the fault persists.

If after the above checks the fault still occurs, get in touch with the nearest After-sales Service.

Always specify:

- a brief description of the fault;
- the type and exact model of the oven;
- the service number (number after the word Service on the rating plate), located on the right hand edge of the oven cavity (visible when the oven door is open). The service number is also indicated on the guarantee booklet;
- your full address;
- your telephone number.

SERVICE



0000 000 00000

If any repairs are required, please contact an authorised **After-sales Service** (to guarantee that original spare parts will be used and repairs carried out correctly).

CLEANING



WARNING

- **Do not use steam cleaning equipment.**
- **Clean the oven only when it is cool.**
- **Disconnect power before servicing.**

Oven exterior

IMPORTANT: do not use corrosive or abrasive detergents. If any of these products unintentionally comes into contact with the appliance, clean immediately with a damp cloth.

- Clean the surfaces with a damp cloth. If it is very dirty, add a few drops of washing up detergent to the water. Finish off with a dry cloth.

Oven interior

IMPORTANT: do not use abrasive sponges or metallic scrapers or scourers. Over time, these can ruin enamelled surfaces and the oven door glass.

- After every use, allow the oven to cool then clean it preferably while it is still warm in order to remove built-up dirt and stains caused by food residues (e.g. food with a high sugar content).
- Use proprietary oven detergents and follow the manufacturer's instructions to the letter.
- Clean the door glass with a suitable liquid detergent. The oven door can be removed to facilitate cleaning (see MAINTENANCE).
- The top heating element of the grill (see MAINTENANCE) can be lowered (some models only) to clean the roof of the oven.

N.B.: during prolonged cooking of foods with a high water content (e.g. pizza, vegetables, etc.) condensation may form on the inside of the door and around the seal. When the oven is cold, dry the inside of the door with a cloth or sponge.

Accessories:

- Soak the accessories in water with washing up detergent immediately after use, handling them with oven gloves if still hot.
- Food residues can be easily removed using a brush or sponge.

Cleaning the rear wall and catalytic side panels of the oven (if present):

IMPORTANT: do not use corrosive or abrasive detergents, coarse brushes, pot scourers or oven sprays which could damage the catalytic surface and ruin its self-cleaning properties.

- Operate the oven empty with the fan-assisted function at 200°C for about one hour
- Next, leave the appliance to cool down before removing any food residue with a sponge.

MAINTENANCE

WARNING

- Use protective gloves.
- Ensure the oven is cold before carrying out the following operations.
- Disconnect power before servicing.

REMOVING THE DOOR

To remove the door:

1. Open the door fully.
2. Lift the catches and push them forwards as far as they will go (Fig. 1).
3. Close the door as far as it will go (A), lift it up (B) and turn it (C) until it is released (D) (Fig. 2).

To refit the door:

1. Insert the hinges in their seats.
2. Open the door fully.
3. Lower the two catches.
4. Close the door.

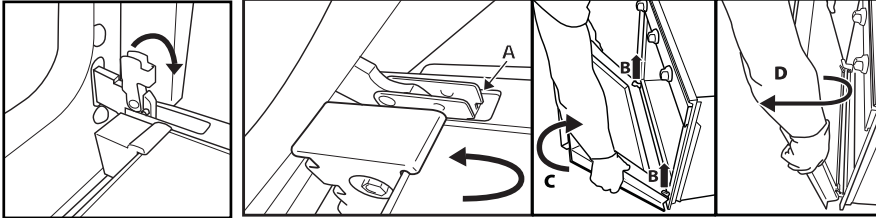

Fig. 1

Fig. 2

MOVING THE TOP HEATING ELEMENT (SOME MODELS ONLY)

1. Remove the side accessory holder grilles (Fig. 3).
2. Pull the heating element out a little (Fig. 4) and lower it (Fig. 5).
3. To reposition the heating element, lift it up, pulling it slightly towards you, be sure it comes to rest on the lateral supports.

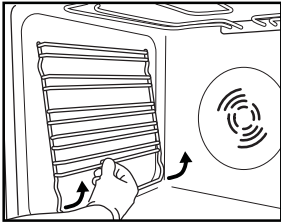

Fig. 3

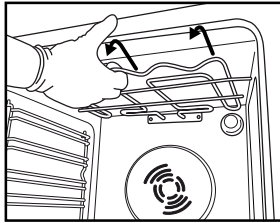

Fig. 4

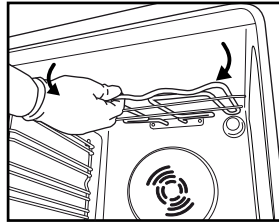

Fig. 5

REPLACING THE OVEN LAMP

To replace the rear lamp (if present):

1. Disconnect the oven from the power supply.
2. Unscrew the lamp cover (Fig. 6), replace the lamp (see note for lamp type) and screw the lamp cover back on (Fig. 7).
3. Reconnect the oven to the power supply.

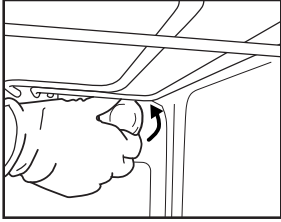

Fig. 6

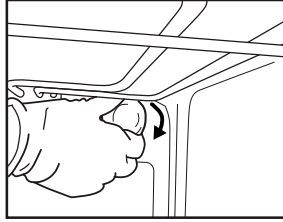

Fig. 7

N.B.:

- Only use 25-40W/230V type E-14, T300°C incandescent lamps or 20-40W/230 V type G9 T300°C halogen lamps (depending on model).
- Lamps are available from our After-sales Service.

IMPORTANT:

- **Do not use the oven until the lamp cover has been repositioned.**

INSTRUCTIONS FOR OVEN USE

FOR ELECTRICAL CONNECTION, SEE THE PARAGRAPH ON INSTALLATION

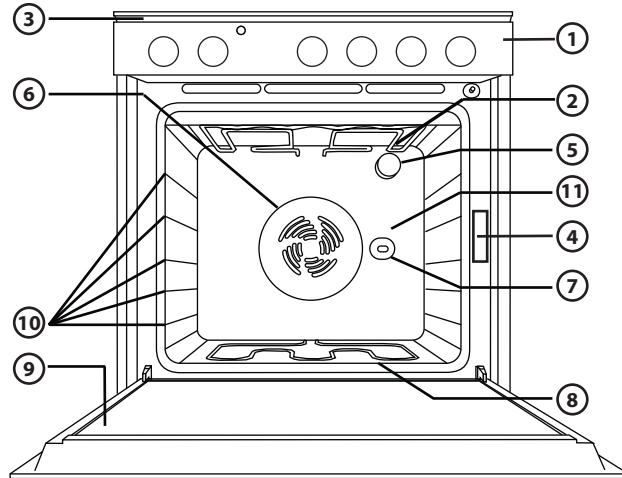

1. Control panel
2. Upper heating element/grill
3. Cooling system (if present)
4. Dataplate (not to be removed)
5. Light
6. Baking ventilation system (if present)
7. Turnspit (if present)
8. Lower heating element (not visible)
9. Door
10. Position of shelves
11. Rear wall

N.B.:

- At the end of cooking, after the oven has been switched off, the cooling fan may continue to run for a while.

COMPATIBLE ACCESSORIES

(for the accessories supplied with oven refer to the tech fiche)

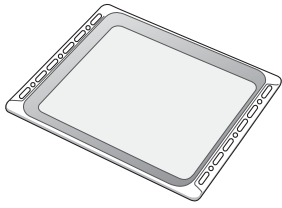

Fig. 1

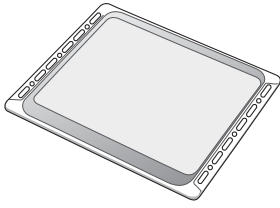

Fig. 2

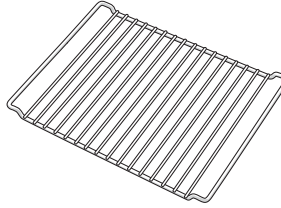

Fig. 3

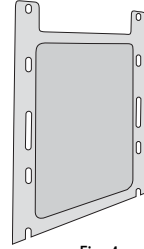

Fig. 4

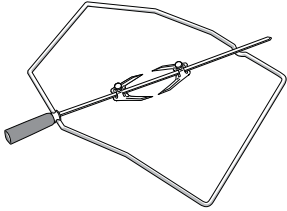

Fig. 5

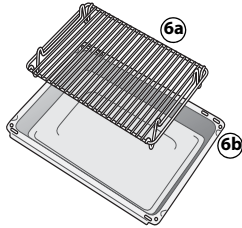

Fig. 6

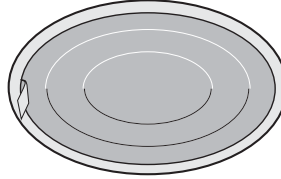

Fig. 7

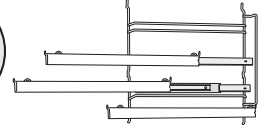

Fig. 8

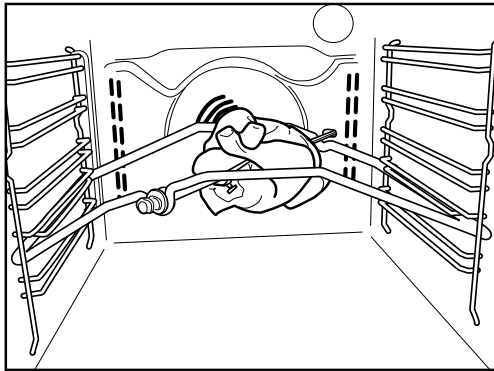

Fig. 9

Drip-tray (Fig. 1)

For collecting fat and bits of food when placed under the wire shelf, or as a plate for cooking meat, chicken and fish, etc., with or without vegetables. Pour a little water into the drip-tray to avoid spatters of fat and smoke.

Baking tray (Fig. 2)

For baking biscuits, cakes and pizzas.

Wire shelf (Fig. 3)

For grilling food or as a support for pots, cake tins and other cooking receptacle. It can be placed on any available level. The wire shelf can be inserted with its curvature facing up or down.

Catalytic side panels (Fig. 4)

These panels have a special microporous enamel coating that absorbs fat spatters. It is advisable to do an automatic cleaning cycle after cooking particularly fatty food (see CLEANING).

Turnspit (Fig. 5)

Use the turnspit as indicated on Fig. 9. Also check "Recommended use and tips" section for advice.

Grill Pan Set (Fig. 6)

The set comprises a wire shelf (6a) and an enameled recipient (6b). This set must be placed on the wire shelf (3) and used with the Grill function.

Grease filter (Fig. 7)

Use **only** for particularly greasy cooking. Hook it on the rear wall of the oven compartment, opposite the fan. It can be cleaned in a dishwasher and used with the fan-assisted function.

Sliding shelves (Fig. 8)

They allow the wire shelves and drip-trays to be pulled half out during cooking. Suitable for all the accessories, they can be cleaned in a dishwasher.

CONTROL PANEL DESCRIPTION

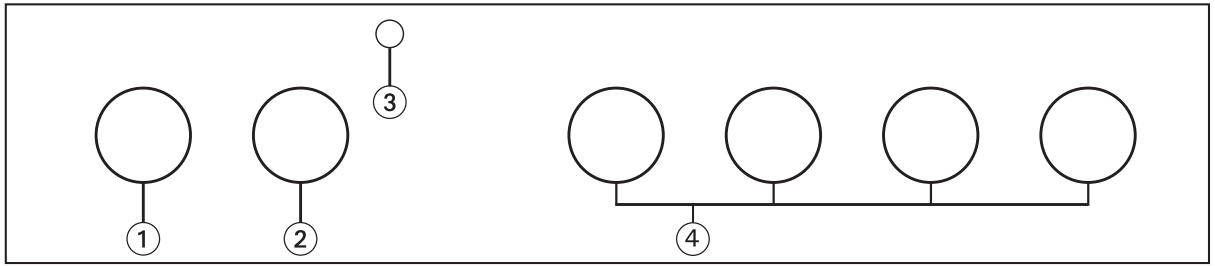

1. Function selector knob
2. Thermostat knob
3. Red thermostat led
4. Hob control knobs

SWITCHING ON THE OVEN

Turn the selector knob to the required function. The oven light switches on.

Turn the thermostat knob clockwise to the required temperature. The red thermostat led lights up, switching off again when the oven reaches the selected temperature. At the end of cooking, turn the knobs to "0".

HOW TO USE THE HOB

The oven control panel features 4 adjustable knobs (from 0 to 6) that control hob operation.

To turn on the electric hotplates:





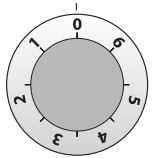

- Turn the control knob of the relevant hotplate clockwise to the desired power setting (see the instructions supplied with the hob).

IMPORTANT:

















- When using the hotplates for the first time, set the knobs to 6 and allow them to operate for approx. 3 minutes in order to eliminate odours, placing a pot with an appropriate diameter and half full of water on each.
- Do not leave the hot plates turned on when they are empty.
- Use pots and pans specifically designed for electric hobs, particularly those with multiple layer flat-bottoms.
- Use pans whose bottom diameter is equal to that of the hotplates, or slightly larger.









FUNCTION DESCRIPTION TABLE

FUNCTION		DESCRIPTION
0	OFF	-
	LAMP	To switch on the oven light.
	CONVENTIONAL	Function suitable for cooking any type of dish on one shelf. Preheat the oven to the required temperature and place the food in it when the set temperature is reached. It is advisable to use the second or third shelf for cooking. This function is also suitable for cooking frozen convenience foods; follow the instructions on the food packaging.
	CONVECTION BAKE	To bake cakes with liquid filling (sweet or savoury) on a single level. This function is ideal also for cooking on two levels. If necessary, switch the positions of the dishes to cook food more evenly.
	GRILL	To grill steak, kebabs and sausages, to cook vegetables au gratin and to toast bread. Preheat the oven for 3-5 min. During cooking the oven door must remain closed. When cooking meat, pour a little water into the drip tray (on the first level) to reduce smoke and fat spatters. Ideally the meat should be turned during cooking.
	TURBOGRILL	To grill large joints of meat (roast beef and other roast meats). The oven door must be kept closed during the cooking cycle. When cooking meat, it is advisable to pour water in the drip-tray placed on the first level. This will reduce smoke and spattering of fat. Turn the meat during grilling.
	DEFROSTING	This function can be used to speed up the thawing of food at room temperature. The food should be placed in the oven in its wrapping to avoid it from drying out.

COOKING TABLE

Recipe	Function	Preheating	Shelf (from bottom)	Temperature (°C)	Time (min)	Accessories
Leavened cakes		Yes	2	160-180	35-55	Wire shelf + cake tin
Biscuits/Tartlets		Yes	3	170-180	15-40	Baking tray
Choux buns		Yes	3	180	30-40	Baking tray
Vols-au-vent / Puff pastry crackers		Yes	3	180-200	20-30	Baking tray
Meringues		Yes	3	90	120-130	Baking tray
Lamb / Veal / Beef / Pork		Yes	2	190-200	90-110	Drip tray or wire shelf + pyrex dish
Chicken / Rabbit / Duck		Yes	2	190-200	65-85	Drip tray or wire shelf + pyrex dish
Turkey / Goose		Yes	2	190-200	140-180	Drip tray or wire shelf + pyrex dish
Baked fish / en papillote (fillet, whole)		Yes	2	180-200	50-60	Drip tray or wire shelf + pyrex dish
Lasagne / Baked pasta / Cannelloni / Flans		Yes	2	190-200	45-55	Wire shelf + pyrex dish
Bread / Focaccia		Yes	2	190-230	15-50	Drip tray or baking tray
Pizza		Yes	2	230-250	7-20	Drip tray or baking tray
Toast		Yes	4	200	2-5	Wire shelf
Vegetable gratin		Yes	3	200	15-20	Wire shelf + pyrex dish
Grilled fish fillets and steaks		Yes	3	200	30-40	Wire shelf + pyrex dish
Sausages / Kebabs / Spare ribs / Hamburgers		Yes	4	200	30-50	Grill + drip tray with water on 1st shelf, turn halfway through cooking
Filled pies (cheesecake, strudel, apple pie)		Yes	1	180-200	50-60	Drip tray or wire shelf + pyrex dish
Meat & potato pies (vegetable pie, quiche lorraine)		Yes	1	180-200	35-55	Wire shelf + cake tin
Stuffed vegetables (tomatoes, peppers, courgettes, aubergines)		Yes	2	180-200	40-60	Wire shelf + pyrex dish
Meat & potato pies (vegetable pie, quiche lorraine)		Yes	1/3	180-190	45-55	Grill + pan, switch levels halfway through cooking
Pizzas/Focaccia		Yes	1/3	230-250	12-30	Baking tray + drip tray, switch levels halfway through cooking

Recipe	Function	Preheating	Shelf (from bottom)	Temperature (°C)	Time (min)	Accessories
Biscuits/Tartlets		-	1/3	170-180	20-40	Baking tray+drip tray, switch levels halfway through cooking
Choux pastry		-	1/3	180	35-45	Baking tray+drip tray, switch levels halfway through cooking
Vols-au-vent / Puff pastry crackers		-	1/3	180-200	20-40	Baking tray+drip tray, switch levels halfway through cooking
Roast chicken		-	2	200	55-65	Grill + drip tray with water on 1st level
Roast potatoes		-	3	200	45-55	Drip tray
Roast Beef underdone		-	3	200	30-40	Grill + drip tray with water on 1st level
Leg of lamb/Knuckle		-	2	200	55-70	Grill + drip tray

N.B.: cooking times and temperatures are approximate for 4 portions.

RECOMMENDED USE AND TIPS

How to read the cooking table

The table indicates the best function to use for any given food, to be cooked on one or more shelves at the same time. Cooking times start from the moment food is placed in the oven, excluding pre-heating (where required). Cooking temperatures and times are purely for guidance and will depend on the amount of food and type of accessory used. Use the lowest recommended values to begin with and, if the food is not cooked enough, then move on to higher values. Use the accessories supplied and preferably dark coloured metal cake tins and oven trays. You can also use pans and accessories in pyrex or stoneware, but bear in mind that cooking times will be slightly longer. To obtain best results, follow the advice given in the cooking table for the choice of accessories (supplied) to be placed on the various shelves. When cooking food that contains lots of water, preheat the oven.

Cooking different foods at the same time

Using the "CONVECTION BAKE" function (if present), you can cook different foods which require the same cooking temperature at the same time (for example: fish and vegetables), using different shelves. Remove the food which requires less cooking time and leave food which requires longer cooking time in the oven.

Desserts

- Cook delicate desserts with the conventional function on one shelf only. Use dark coloured metal cake tins and always position them on the wire shelf supplied. To cook on more than one shelf, select the forced air function and stagger the position of the cake tins on the shelves, aiding optimum circulation of the hot air.
- To check whether a raising cake is cooked, insert a wooden toothpick into the centre of the cake. If the toothpick comes out clean, the cake is ready.
- If using non-stick cake tins, do not butter the edges as the cake may not rise evenly around the edges.
- If the cake "sinks" during cooking, set a lower temperature the next time, perhaps reducing the amount of liquid in the mixture and mixing more gently.
- For sweets with moist fillings (cheesecake or fruit pies) use the "CONVECTION BAKE" function (if present). If the base of the cake is soggy, lower the shelf and sprinkle the bottom of the cake with breadcrumbs or biscuit crumbs before adding the filling.

Meat

- Use any kind of oven tray or pyrex dish suited to the size of the piece of meat being cooked. For roast joints, it is best to add some stock to the bottom of the pan, basting the meat during cooking for added flavour. When the roast is ready, let it rest in the oven for another 10-15 minutes, or wrap it in aluminium foil.
- When you want to grill meat, choose cuts with an even thickness all over in order to achieve uniform cooking results. Very thick pieces of meat require longer cooking times. To avoid the meat from burning on the outside, lower the position of the wire shelf, keeping the food farther away from the grill. Turn the meat two thirds of the way through cooking.

To collect the cooking juices it is advisable to place a drip-tray with half a litre of water directly under the grill on which the meat is placed. Top-up when necessary.

Turnspit (only in some models)

Use this accessory to evenly roast large pieces of meat and poultry. Place the meat on the spit rod, tying it with string if chicken, and check that it is secure before inserting the rod in the seat located on the front wall of the oven and resting it on the respective support. To avoid smoke and to collect cooking juices, it is advisable to place a drip-tray with half a litre of water on the first level. The rod has a plastic handle which must be removed before starting to cook, and used at the end of cooking to avoid burns when taking the food out of the oven.

Pizza

Lightly grease the trays to ensure the pizza has a crispy base. Scatter the mozzarella over the pizza two thirds of the way through cooking.

Rising function (present only in specific models)

It is always best to cover the dough with a damp cloth before placing it in the oven. Dough proving time with this function is reduced by approximately one third compared to proving at room temperature (20-25°C). Proving time for a 1 Kg batch of pizza dough is around one hour.

04/2011

5019 610 01204



Whirlpool is a registered trademark of Whirlpool, USA