

DAILY REFERENCE GUIDE

THANK YOU FOR PURCHASING A WHIRLPOOL PRODUCT



To receive more comprehensive help and support, please register your product at www.whirlpool.eu/register



You can download the Safety Instructions and the Use and Care Guide by visiting our website docs.whirlpool.eu and following the instructions on the back of this booklet.

! Before using the appliance carefully read the Health and Safety guide.

PRODUCT DESCRIPTION

APPLIANCE

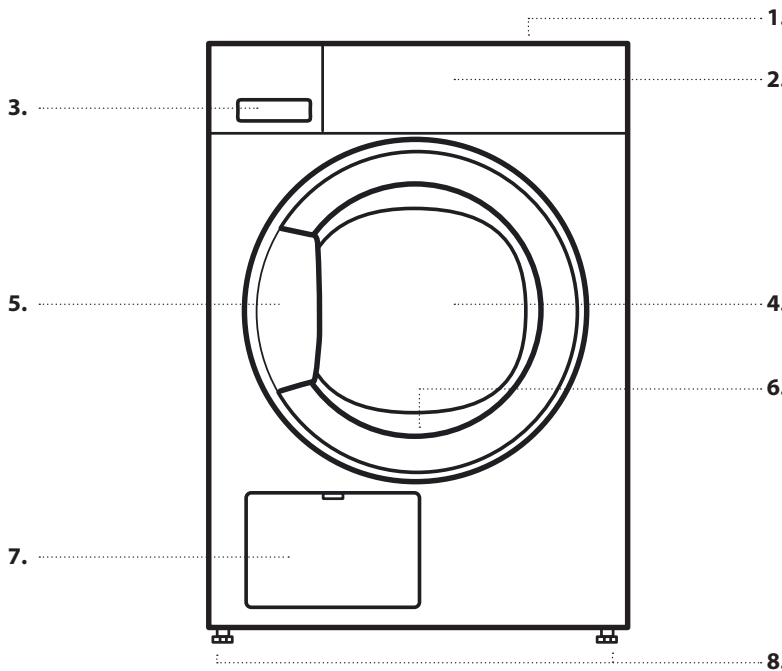

- 1. Worktop
- 2. Control panel
- 3. Water tank
- 4. Door
- 5. Door handle
- 6. Door filter (behind door)
- 7. Condenser (= bottom filter; behind flap)
- 8. Adjustable feet (4)

CONTROL PANEL

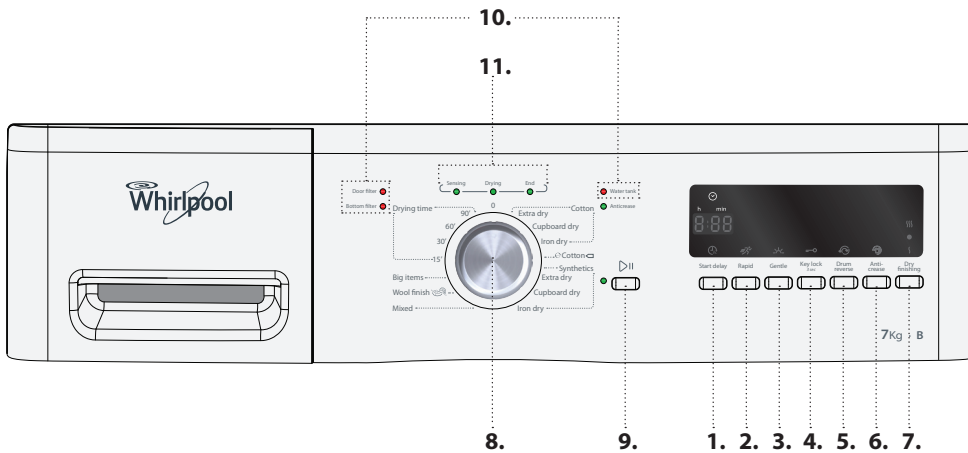

- 1. Start delay function
- 2. Rapid option
- 3. Gentle option
- 4. Key lock
- 5. Drum reverse option
- 6. Anti-crease option
- 7. Dry finishing option
- 8. Programme selector
- 9. Start/Pause button
- 10. Failure indicators
- 11. Programme sequence indicator



SENSING THE DIFFERENCE

FIRST TIME USE

BEFORE USING THE DRYER

CHECK DRAIN HOSE AND WATER TANK

Make sure that the drain hose on the back of the dryer is fixed correctly, either to the dryer's water tank (see picture), or to your domestic sewage system (see Installation guide).

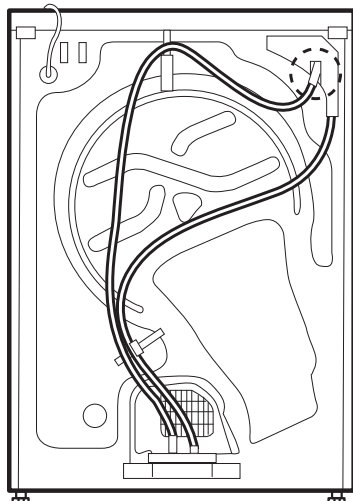

Also make sure that the water tank is correctly inserted.

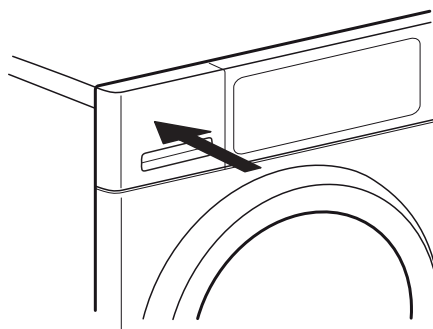

DAILY USE

See *Use and Care Guide* for more details on functions /
see last page for information on how to obtain the *Use and Care Guide*

⚠ WARNING

Make sure that no lighters or matches remain in the laundry.

Make sure that the laundry is not soaked with flammable liquids.

1. LOAD LAUNDRY

Prepare your laundry according to the recommendations in section **HINTS AND TIPS**.

Make sure that pockets are empty, fasteners closed and ribbons tied together.



Open the door and load the laundry. Observe the maximum load sizes given in the **PROGRAMME CHART**.



2. CLOSE DOOR

Make sure that no laundry gets stuck between door glass and door filter.



Close the door so that you can hear it click shut.

3. SET THE DESIRED PROGRAMME

Turn the knob to select the desired programme.
The default programme duration appears on the display.

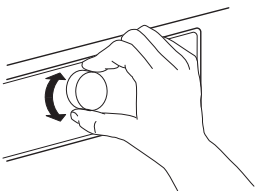

Find more information regarding programmes in the **PROGRAMME CHART**.

Select options, if needed

If you want to select additional options, press the respective button - the symbol on the display lights up.

Refer to section **OPTIONS, FUNCTIONS AND INDICATORS** for more information.

4. START PROGRAMME

Press the *Start/Pause* button; the indicator next to the button lights up. The drying process starts.

The remaining programme duration is indicated on the display. It can be recalculated and adapted in the course of the programme. During such phases, an animation occurs on the display.

5. CHANGE THE SETTINGS OF A RUNNING PROGRAMME, IF NEEDED

To change the settings of a running programme or start delay:

- press *Start/Pause* to put the running programme on pause
- change your settings
- press *Start/Pause* again to continue the programme.

6. RESET A RUNNING PROGRAMME, IF NEEDED

Turn the programme selector to Off/O.

⚠ WARNING

Immediately open the door and unload the laundry, so that eventual heat in the laundry can dissipate.

7. SWITCH OFF THE DRYER AFTER PROGRAMME END

At the end of the programme, „End“ appears on the display. Turn the programme selector to Off/O to switch off the dryer. Open the door and take out your laundry.

End

If you do not switch the dryer off after programme end, the dryer drum rotates from time to time the next 10 minutes after programme end, to reduce creasing of the laundry. The dryer will switch off automatically in about a quarter of an hour after programme end, to save energy.

8. EMPTY WATER TANK / CLEAN DOOR FILTER / CLEAN BOTTOM FILTER

Refer to section **CARE AND MAINTENANCE**.

HINTS AND TIPS

Respect the care labels of your laundry; make sure that it is appropriate for being treated in a dryer.

CARE LABELS

The dots indicate the temperature degree for drying the laundry.

 Normal temperature

 Reduced temperature

 Do not tumble dry

EMPTY ALL POCKETS

Objects like coins or keys can damage your laundry as well as the drum.

SAVING TIPS

Always dry a full load; this optimizes the relative energy consumption. The maximum load sizes for the various programmes are indicated in the programme chart.

To reduce the drying time, make sure that the laundry is spun with the maximum possible spin speed of the wash programme. This reduces the moisture content in the laundry.

CONSUMPTION DATA

Data can differ in your home, mainly depending on the moisture content of the laundry load.

Programme	Load (Kg)	Spin Speed (rpm)	Humidity (%)	Energy consumption (kWh)	Drying Time (min)
ECO COTTON *	7	1000	60	4.22	124
	3.5	1000	60	2.33	72
ECO COTTON	7	800	70	4.96	139
	7	1400	50	3.46	105
COTTON IRON DRY	7	800	70	3.83	114
	7	1000	60	3.43	98
	7	1400	50	3.03	87
SYNTHETICS CUPBOARD DRY	3.5	1000	40	1.44	46









*Reference programmes for Energy Label / Regulation 392/2012 / EU Values are based on the default programme setting, with clean door and bottom filter. For consumer tests, the door filter and bottom filter need to be cleaned after each cycle.

The energy consumption and drying time may differ from the values above. They depend on the operation conditions in your home (such as voltage fluctuation, mixture of textiles, humidity of the textiles after spinning, load volume).

The values are determined according to European Norm 61121 and refer to the default programme setting; changing the setting also impacts the consumption data.

Power Consumption - Watts	
Left-on mode	0.81
Off-mode	0.11

PROGRAMME CHART

Programme		Care labels	Max load	Options				
				Rapid 	Gentle 	Drum reverse 	Anti-crease 	Dry finishing 
Cotton	Extra dry		max	✓	✓	✓	✓	✓
	Cupboard dry			✓	✓	✓	✓	✓
	Iron dry			✓	✓	✓	✓	✓
e Cotton 			max	✓	✓	—	✓	✓
Synthetics	Extra dry		3.5	—	✓	✓	✓	✓
	Cupboard dry			—	✓	✓	✓	✓
	Iron dry			—	✓	✓	✓	✓
Mixed			3.0	—	✓	✓	✓	✓
Wool finish 			1.0	—	—	—	—	—
Big items			3.0	—	—	✓	✓	—
Drying time			max	—	—	—	✓	—

✓ Selectable / Optional — Not Selectable / Applicable

Maximum load sizes: 7 kg

PROGRAMMES

Make sure that your laundry is suitable to be treated in a tumble dryer. Refer to **HINTS AND TIPS** / Care labels.

ECO COTTON



For drying normally wet cotton laundry.
Standard cotton programme, suitable to dry normal wet cotton laundry. Most efficient programme in terms of energy consumption for drying cotton laundry.
The values on the Energy Label are based on this programme.

COTTON

For drying cotton laundry.

SYNTHETICS

For drying laundry made of synthetic fibres.

MIXED

For drying mixed laundry loads made of cotton, linen, synthetic fibres and their blends.

WOOL FINISH

For finishing the air-drying process of woolen textiles. Woolens get fluffy and smooth.

BIG ITEMS

For drying big laundry items, such as sleeping bags, blankets etc.

DRYING TIME

Time-restricted drying programme. Select programme duration of 15, 30, 60 or 90 minutes.
For all fabrics appropriate for tumble drying. Also suitable to add an additional short 15 minutes drying phase after programme end.

OPTIONS, FUNCTIONS AND INDICATORS

Refer to the programme chart to check which options are available for the selected programme.

OPTIONS



Rapid

Enables quicker drying.



Gentle

Enables a more gentle treatment of the laundry by reducing the drying temperature.



Drum reverse

Reduces creasing by increased drum reverse phases during the programme.



Anti-crease

Helps to prevent creasing if you cannot unload the laundry soon after programme end.

The dryer starts to tumble the laundry periodically a few minutes after programme end. This tumbling will last up to approximately 12 hours after end of the programme. You can stop it at any time by switching off the dryer by turning the programme selector to Off/0 position.

Dry finishing

Enables slight variation of the dryness level at the end of the programme by prolonging or shortening the programme duration.



slightly dryer



standard dryness



slightly more humid

OPTIONS RAPID AND GENTLE ARE NOT COMBINABLE

FUNCTIONS



Start delay

Moves the start of your programme to a later time. Choose a delay up to 12 hours.

- Select programme and options.
- Press the *Start delay button* repeatedly until the desired delay time appears on the display.
- Press *Start / Pause* - the display shows the countdown of the delay until start of the programme. The start delay symbol on the display blinks, and the *Start / Pause button* lights up. A sound by activation of the pump may occur.
- After the delay has expired, the dryer starts automatically. On programme start, the display indicates the remaining programme duration.

To cancel the *Start delay*

- Turn the programme selector to the Off/O position, or to another programme.



Key lock

To lock the buttons and knob of the control panel against unwanted operation.

To lock the buttons and knob:

- A programme must be selected.
- Press and hold the *Key lock button* until the key symbol lights up on the display. Knob and keys are locked now. With activated key lock, the only working function is to switch the dryer off by turning the programme selector to the Off/O position. If you switch the dryer on again by selecting a programme, the key lock will remain active until you unlock it.

To unlock buttons and knob:

- Press and hold the *Key lock button* until the key symbol on the display goes off.

INDICATORS

Failure indicators:

Water tank

(=> empty water tank)

Bottom filter

(=> clean bottom filter).

Door filter

(=> clean door filter)

In case of any failures, refer to section **TROUBLESHOOTING** in the **USE AND CARE GUIDE**.

Programme sequence indicator

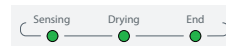

Shows the current programme phase (sensing / drying process / programme end).

Anticrease

Indicates that the dryer is in the tumbling phase after programme end, to avoid creasing of the laundry (refer to DAILY USE / 7, and to OPTIONS, FUNCTIONS AND INDICATORS / Anti-crease).

CARE AND MAINTENANCE

WARNING

Switch off and unplug the dryer before doing any cleaning and maintenance.

Caution, the water in the water tank can still be hot.

EMPTY WATER TANK AFTER EACH DRYING CYCLE

Hold the handle and carefully pull out the water tank. Hold the full water tank with both hands. Empty the water and insert the container by pushing it back into place. Make sure that it is properly inserted.

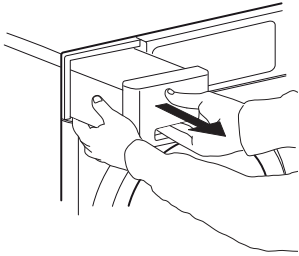

CLEAN DOOR FILTER AFTER EACH DRYING CYCLE

Open the door and remove the door filter by pulling it upwards.

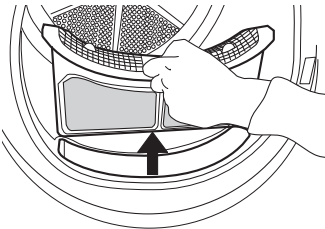

Press the button to open the door filter. Remove the lint inside. Close the filter and reinsert it in the right direction, so that it completely integrates in the filter chamber.

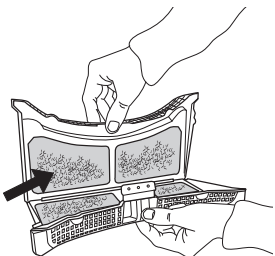

CLEAN THE BOTTOM FILTER ABOUT EVERY TWO MONTHS

Open the bottom flap. Turn the locking bars right and left on the bottom filter downwards in horizontal position. Hold the bottom filter on the handle and pull it out.

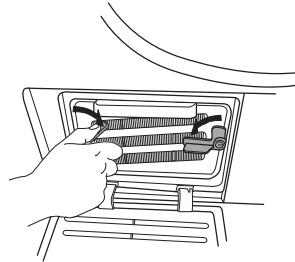

Clean the bottom filter under running water; wipe away dust and lint.

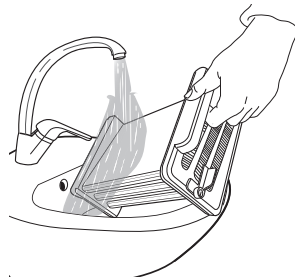

Clean the filter chamber of the dryer with a damp cloth or carefully with a vacuum cleaner. Insert the bottom filter again. Turn the locking bars upwards in vertical position. Close the bottom flap.

PRODUCT FICHE

 [www](http://www.docs.whirlpool.eu) The product fiche with energy data of this appliance can be downloaded from Whirlpool Website docs.whirlpool.eu

HOW TO OBTAIN THE USE AND CARE GUIDE

- >  [www](http://www.docs.whirlpool.eu) Download the Use and Care Guide from our website docs.whirlpool.eu (you can use this QR code), specifying the product's commercial code.
- > Alternatively, contact our Client After-sales Service



CONTACTING OUR AFTER-SALES SERVICE

You can find our contact details in the warranty manual. When contacting our Client After-sales Service, please state the codes provided on your product's identification plate.

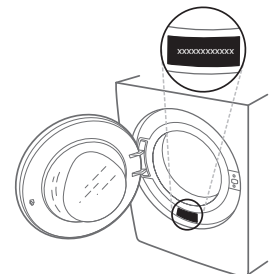

400011046841

Printed in Italy