



THANK YOU FOR BUYING A HOTPOINT PRODUCT
In order to receive a more complete assistance, please register your product on www.hotpoint.eu/register



Before using the appliance carefully read the Safety Instruction.

PRODUCT DESCRIPTION

FIRST TIME USE

Wait at least two hours, after the installation, before connecting the appliance to the power supply. Connect the appliance to the power supply it starts the operation automatically. The ideal storage temperatures for the food are preset in the factory.

After turning the appliance on, you must wait for 4-6 hours for the correct storage temperature to be reached for a normally filled appliance. Position the antibacterial anti-odour filter in the fan as demonstrated in the filter packaging (if available). If the audible signal sounds, it means that the temperature alarm has intervened: press the button to switch off the acoustic alarms.

CONTROL PANEL

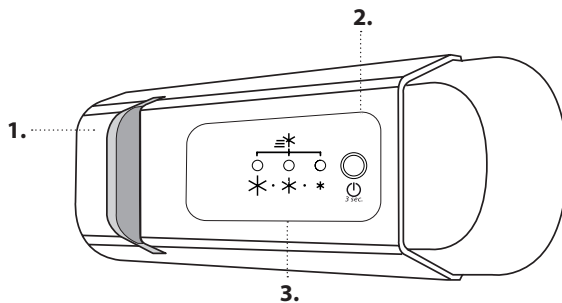

1. LED Light
2. On/Stand-by
3. Freezer and refrigerator compartment temperature button

ON/STAND-BY





Press the button for 3 seconds to turn the appliance off. In Stand-by mode the light in the refrigerator compartment does not turn on. Press the button again briefly to reactivate the appliance.

Note: this does not disconnect the appliance from the power supply.

FREEZER AND REFRIGERATOR COMPARTMENT TEMPERATURE

The three LED indicators indicate the refrigerator compartment set temperature. It is possible to set a different temperature of the appliance with the  button.

The following adjustments are possible:

LEDs lit	Set temperature
	High (less cold)
	Medium-high
	Medium
	Medium-low
	Low (colder)



FAN*

You can turn the Fan on/off by pressing the button on the shown in the figure). If the ambient temperature exceeds 27°C, or if drops of water are present on the glass shelves, it is essential that the fan is on to ensure the proper preservation of the food. Deactivation of the fan allows energy consumption to be optimised.

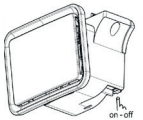

FREEZING FRESH FOOD

Place the fresh food to be frozen in the FREEZING ZONE in the freezer compartment avoiding the direct contact with the food that is already frozen. To optimize the freezing speed, the lower drawer can be removed and the food can be placed directly on the bottom of the compartment.

FAST COOL FUNCTION (FAST COOLING)

To quickly cool the refrigerator compartment, or 6 hours before putting a large quantity of food to be frozen in the freezer compartment, turn on the "Fast Cooling" function by repeatedly pressing the  button until the 3 icons flash green and then stay constant.

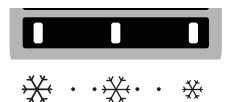

The function automatically turns off after 30 hours and the temperature returns to the previous setting when the function is turned on.

To turn the function off manually, press the button.

Note: avoid a direct contact between the fresh food and the food that is already frozen.

To optimize the freezing speed, the lower drawer can be removed and the food can be placed directly on the bottom of the compartment.

Recommended setting:

- Refrigerator compartment: MEDIUM

To avoid food waste, please refer to the recommended setting and storage times found in the online user manual.

* Available only on certain models

Light system (depending on model)



This product contains a light source of energy efficiency class G

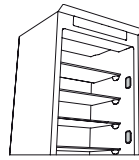

This product contains 4 lateral light sources of energy efficiency class F

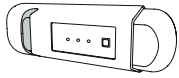

This product contains a light source of energy efficiency class G



This product contains 4 lateral light sources of energy efficiency class F and a top light source of energy class G



This product contains a top light source of energy efficiency class G

FREEZER COMPARTMENT

Freezing fresh food

1. It is advisable to set the temperature colder or turn on the Fast Freeze/ Fast Cool* at least four hours before removing the food from the freezer compartment, to prolong the preservation of the food during the defrosting phase.
2. To defrost, unplug the appliance and remove the drawers. Leave the door open to allow the frost to melt. To prevent the water from escaping during the defrost, it is advised that you place an absorbent cloth on the bottom of the freezer compartment and wring it out regularly.
3. Clean the inside of the freezer compartment with the ice scraper and dry it carefully.

4. Turn the appliance back on and put the food back inside. To remove the frost on the STOP FROST* accessory, follow the CLEANING.

Ice cubes*

Fill 2/3 of the ice tray with water and put it back in the freezer compartment. Do not, under any circumstances, use sharp or pointed objects to remove the ice.

The quantity of fresh food that can be frozen in a specific time period is indicated on the rating plate.

Load limits are determined by baskets, flaps, drawers, shelves etc. Make sure that these components can still close easily after loading

GENERAL INFORMATION

The drawers, baskets and shelves should be kept in their current position unless otherwise specified in this quick guide. The light system inside the refrigerator compartment uses LED lights, allowing for better lighting than with traditional light bulbs, as well as for very low energy consumption.

Doors and lids of the refrigeration appliance should be removed before disposal in the landfill, to avoid children or animals getting trapped inside.

STOP FROST SYSTEM*

The STOP FROST SYSTEM facilitates the defrost procedure for the freezer compartment.

The STOP FROST accessory is designed to collect some of the frost that forms in the freezer compartment and it is easy to remove and clean, therefore reducing the time needed to defrost the freezer compartment.

To remove the frost on the STOP FROST accessory follow the cleaning procedure demonstrated below.

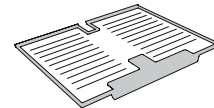

PROCEDURE TO CLEAN THE STOP FROST ACCESSORY

1. Open the freezer compartment door and remove the upper drawer.

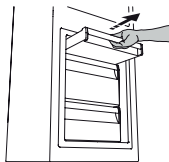

2. Unfasten the STOP FROST accessory and remove it, taking care not to drop it on the glass shelf below.

Note: if the accessory is jammed or difficult to remove, do not keep trying to remove it, but proceed with the complete defrost of the freezer compartment.

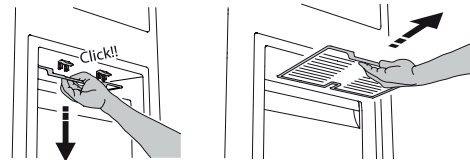

3. Close the door of the freezer compartment.
4. Remove the frost on the accessory by rinsing it under running (not hot) water.



* Available only on certain models

5. Let the accessory drip dry and dry the plastic parts with a soft cloth.

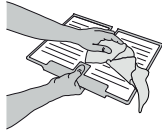

6. Reinsert the accessory by placing the back part on the projections shown in figure, then refasten the handle of the accessory to the clasps above.

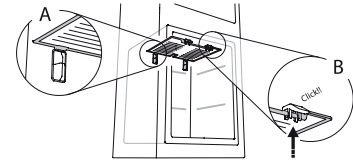

7. Reinsert the upper drawer and close the door of the freezer compartment.



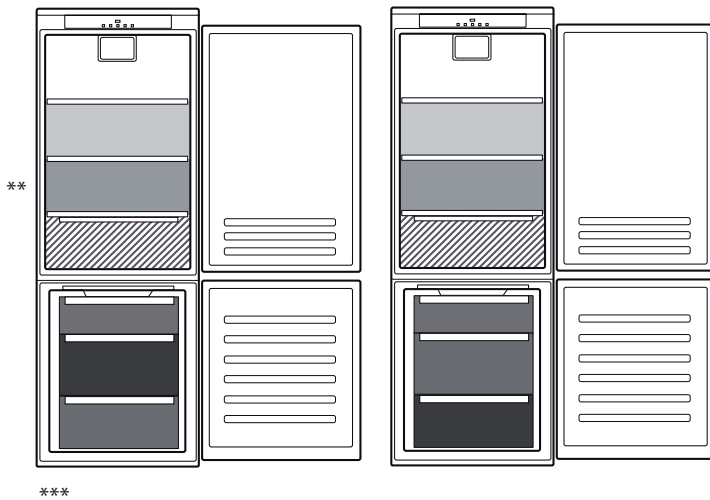

It is possible to clean the STOP FROST accessory on its own without completely defrosting the freezer compartment. Cleaning the STOP FROST accessory regularly helps to reduce the need to completely defrost the freezer compartment.

Note: the product specifications, including volume and energy, are calculated without the STOP FROST accessory.

HOW TO STORE FOOD AND BEVERAGE

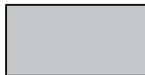

Legend

	TEMPERATE ZONE Suggested for storage of tropical fruit, cans, drink, eggs, sauces, pickles, butter, jam
	COOL ZONE Suggested for storage of cheese, milk, daily food, delicatessen, yoghurt
	COOLEST AREA Suggested for storage of cold cuts, desserts, meat and fish
	FRUIT & VEGETABLE DRAWER
	FREEZER DRAWERS
	FREEZING ZONE DRAWER (Max cool zone) Suggested to freeze fresh/cooked food

** For models with "0 ° ZONE" COMPARTMENT the "coolest area" is the one highlighted in the legend

*** Only for CB310 e CB380 models (refer to the Rating plate located at side of Fruit and vegetable drawer)

* Available only on certain models

TROUBLESHOOTING

What to do if...	Possible reasons	Solutions
The control panel is switched off, the appliance does not work.	There may be an appliance power supply problem.	Check that: <ul style="list-style-type: none"> • there is not a power outage; • the plug is properly inserted in the power socket and the mains double-pole switch (if present) is in the correct position (i.e. allows the appliance to be powered); • the household electrical system protection devices are efficient; • the power cable is not damaged.
	The appliance could be in On/stand by mode.	Turn the appliance on by briefly pressing the "Temp." button (see On/Stand-by function).
The inside light does not work.	The light may need to be replaced. Malfunction of a technical component.	Disconnect the appliance from the power supply and contact the Technical Assistance Service if you need a replacement.
The inside light flashes.	Door alarm active. It is activated when the refrigerator compartment door remains open for a prolonged period of time.	To stop the alarm, close the refrigerator door. On reopening the door, check the light works.
The temperature inside the compartments is not low enough.	There could be various causes (see "Solutions").	Check that: <ul style="list-style-type: none"> • the doors close properly; • the appliance is not installed near a heat source; • the set temperature is adequate; • the circulation of air through the vents at the bottom of the appliance is not obstructed (see installation section).
There is water on the bottom of the refrigerator compartment.	The defrost water drain is blocked.	Clean the defrosting water drain (see section "Cleaning and Maintenance").
Excessive amount of frost in the freezer compartment	The door of the freezer compartment does not close properly.	<ul style="list-style-type: none"> • Check that there is nothing preventing the door from closing properly. • Defrost the freezer compartment. • Make sure the appliance has been correctly installed.
The front edge of the appliance, at the door striker seal, is hot.	This is not a defect. It prevents condensation from forming.	No solution is necessary.
One or more green symbols are flashing continuously and it is not possible to change the temperature set.	Malfunction alarm. The alarm indicates a fault in a technical component.	Contact Technical Assistance Service.
The temperature of the refrigerator compartment is too cold.	<ul style="list-style-type: none"> • The set temperature is too cold. • A large amount of fresh food may have been placed in the freezer compartment. 	<ul style="list-style-type: none"> • Try to set a less cold temperature. • If fresh food has been placed in the freezer compartment, wait until it has fully frozen. • Turn off the fan (if present) following the procedure described in the paragraph "FAN".

* Available only on certain models



Policies, standard documentation, ordering of spare parts and additional product information can be found by:

- Visiting our website docs.hotpoint.eu and parts-selfservice.whirlpool.com
- Using QR Code
- Alternatively, **contact our After-sales Service** (See phone number in the warranty booklet). When contacting our After-sales Service, please state the codes provided on your product's identification plate.

The model information can be retrieved using the QR-Code indicated on the energy label. The label also includes the model identifier that can be used to consult the <https://eprel.ec.europa.eu> database portal.



Hotpoint



400011715441