

DAILY REFERENCE GUIDE



THANK YOU FOR PURCHASING A WHIRLPOOL PRODUCT

To receive more comprehensive help and support, please register your product at www.whirlpool.eu/register



You can download the Safety Instructions and the Use and Care Guide by visiting our website docs.whirlpool.eu and following the instructions on the back of this booklet.



Before using the appliance carefully read the Health and Safety guide.

PRODUCT DESCRIPTION

APPLIANCE

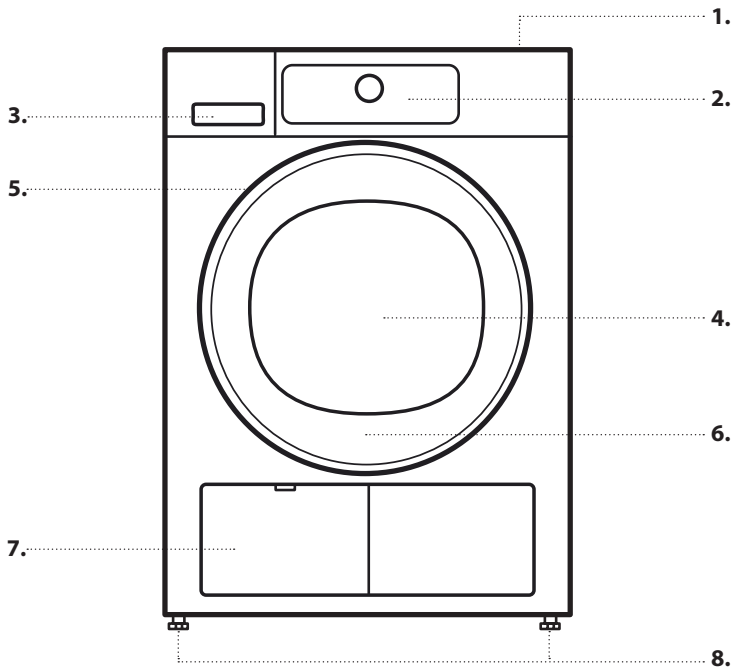

- 1. Worktop
- 2. Control panel
- 3. Water tank
- 4. Door
- 5. Door handle
- 6. Door filter (behind door)
- 7. Bottom filter (behind flap)
- 8. Adjustable feet (4)

CONTROL PANEL

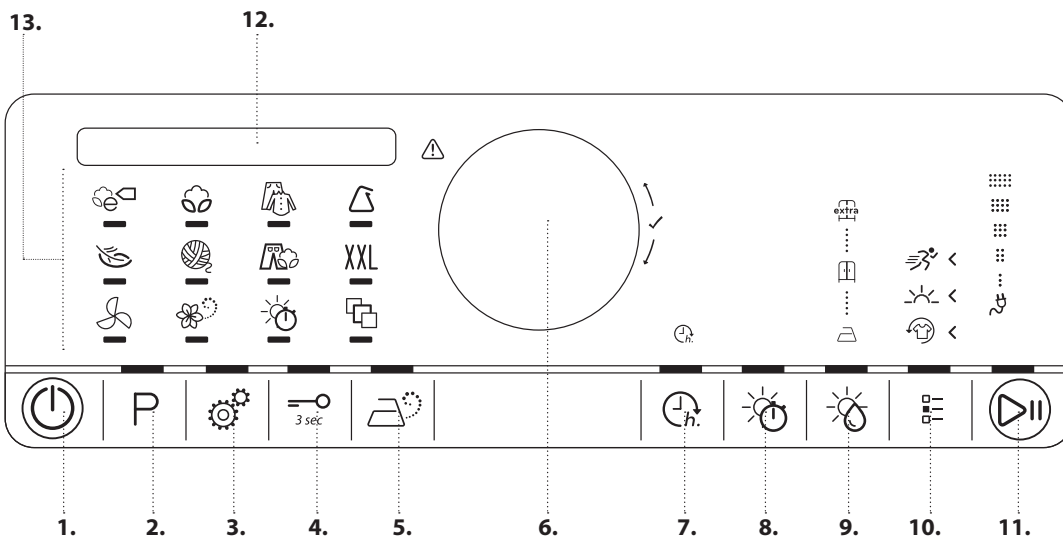

- 1. On/Off button (Reset if long pressed)
- 2. Programme button
- 3. Settings button
- 4. Key lock
- 5. Steam option
- 6. Knob (Turn to select / Press to confirm)
- 7. Finish in
- 8. Drying time
- 9. Dryness level
- 10. Options button
- 11. Start / Pause button
- 12. Display
- 13. Programmes area



SENSING THE DIFFERENCE

FIRST TIME USE

BEFORE USING THE DRYER

CHECK DRAIN HOSE AND WATER TANK

Make sure that the water tank is correctly inserted.

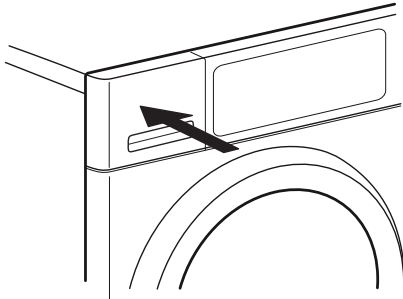

Make sure that the drain hose on the back of the dryer is fixed correctly, either to the dryer's water tank, or to your domestic sewage system (see Installation guide).

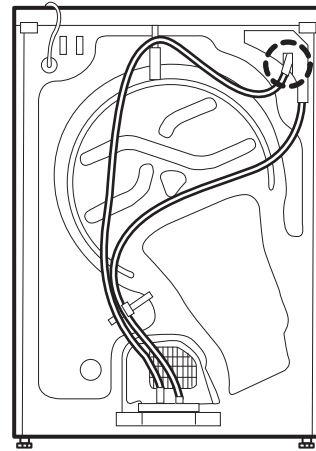

When switching on the dryer for the first time, you will be asked to

- Set the desired language
- Adapt the value for your local water conductivity
- Set the dryer to recall the last used programme setting or not when switching it on.

Refer to HINTS AND TIPS and OPTIONS, FUNCTIONS AND INDICATORS / Settings.

DAILY USE

See Use and Care Guide for more details on functions / see last page for information on how to obtain the Use and Care Guide

⚠ WARNING

Make sure that no lighters or matches remain in the laundry



Make sure that the laundry is not soaked with flammable liquids.

1. LOAD LAUNDRY

- Prepare your laundry according to the recommendations in section "HINTS AND TIPS".
Make sure that pockets are empty.
- Open the door and load the laundry. Observe the maximum load sizes given in the PROGRAMME CHART.



2. CLOSE THE DOOR

- Make sure that no laundry gets stuck between door glass and door filter.  
- Close the door so that you can hear it click shut.

3. SWITCH ON DRYER

- Press the *On/Off* button until the programme button lights up. An animation occurs, and there is a sound. Afterwards the dryer is ready to be operated. 

4. SET THE DESIRED PROGRAMME

GUIDED MODE - the button light will guide you through setting your programme in the following order: selection of programme / drying time (ONLY if Drying time or Airing programme is selected) / dryness level (only if selectable/adjustable) / options. As soon as you confirm a selection by pressing the knob, the button light will jump to the next step.

• Select programme:

Make sure that the programme button lights up.

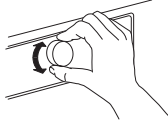

Turn the knob to select the desired programme. The indicator next to the selected programme lights up. Confirm by pressing the knob.

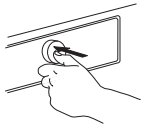

Programme position  offers a choice of special programmes, which you can select by turning the knob; afterwards press the knob to confirm the selected programme. Find more information regarding programmes in the Programme Chart.

• Select Drying time, if needed



ONLY if you have selected programme Drying time or Airing, you can set the desired drying / airing time from a minimum of 10 minutes to maximum 180 minutes (three hours). Make sure that the Drying time button lights up. Turn the knob to select the desired drying / airing time. Confirm it by pressing the knob.

• Set dryness level, if needed



If you want to change the dryness level, make sure that the Dryness level button lights up. Turn the knob to select the desired dryness level, then press the knob to confirm.

• Select options, if needed

- If you want to select additional options, make sure that the options button lights up. The options which are selectable for your programme are indicated by lighting arrows .

Turn the knob to select the desired options. The symbol of the selected option blinks. To confirm it, press the knob. Some options / functions can be selected by directly pressing the button:



Refer to section OPTIONS, FUNCTIONS AND INDICATORS for more information.

INDIVIDUAL MODE

After you have switched on the dryer, you are not forced to follow the GUIDED MODE.

It is up to you which order you choose to set your programme. To do a setting, first press the relevant button, then turn the knob to select, and finally press the knob to confirm.

The variety of options and dryness levels depends on the programme selected. Therefore it is recommended to start your setting with selecting the programme.

P

5. START PROGRAMME



- Press and hold Start/Pause until the button lights up solidly; the drying process starts.
- The duration can be recalculated and adapted in the course of the programme. During such phases, an animation occurs on the display.

6. CHANGE THE SETTINGS OF A RUNNING PROGRAMME, IF NEEDED

You can still change some settings after a programme was started: Adjust drying time (only if programme Drying time or Airing is selected):

Adjust or cancel "Finish in", if a delay was selected and started
Add or cancel an option, provided the progress of the programme still allows it.

- Press the relevant button. The selected setting will blink for a few seconds.
- While blinking, you can adjust the setting by turning the knob. If the value or setting stopped blinking, press the button again.
- Press the knob to confirm the modification. If you do not confirm, the modification will be confirmed automatically – the modified setting will stop blinking.

The programme will continue automatically.

To change the settings of a running programme or delay, you can also:

- Press Start/Pause to put the running programme on pause
- Change your settings
- Press Start/Pause again to continue the programme.

7. RESET A RUNNING PROGRAMME, IF NEEDED



- Press and hold the On/Off button until the display indicates that the programme is cancelled.

8. SWITCH OFF THE DRYER AFTER PROGRAMME END



- The display indicates that the cycle has finished. Press On/Off to switch off the dryer. Open the door and take out your laundry.
- The dryer will switch off automatically in about a quarter of an hour after programme end, to save energy.
- If not switched off right after programme end, the dryer will tumble the laundry for about 10 minutes, to prevent creasing. The display shows an animation.

9. EMPTY WATER TANK / CLEAN DOOR FILTER / CLEAN BOTTOM FILTER

- Refer to section CARE AND MAINTENANCE.

PROGRAMME CHART

Programme		Care labels	Max load (Kg)	Directly selectable			Selectable by options button		
				Dryness level	Steam option	Drying time	Fresh Care	Gentle	Rapid
ECO COTTON			max		—	—		—	—
COTTON			max		—	—			—
						—			
MIXED			2,0	—		—			—
SYNTHETICS			3,5		—	—			—
						—			—
DELICATES			2,5		—	—		—	—
WOOL EXCELLENCE			1,0		—	—	—	—	—
JEANS			3,0		—	—			—
BIG ITEMS	XXL		3,0		—	—		—	—
AIRING			max	—	—			—	—
STEAM REFRESH			1,5	—	—	—	—	—	—
DRYING TIME			max	—	—			—	—
SHIRTS			2,5		—	—			—
SILK			2,5		—	—		—	—
SPORT			2,5		—	—		—	—
TOWELS			5		—	—			
OUTDOOR			2		—	—		—	—
DOWN JACKETS			1,5		—	—		—	—
MINI LOAD			1,0		—	—		—	—

Selectable / Optional — Not Selectable / Applicable

Maximum load sizes: 8 kg

HINTS AND TIPS

Respect the care labels of your laundry; make sure that it is appropriate for being treated in a dryer.

DRYING CARE LABELS

The dots indicate the temperature degree for drying the laundry



Normal temperature



Reduced temperature



Do not tumble dry

SAVING TIPS

- To reduce the drying time, make sure that the laundry is spun with the maximum possible spin speed of the wash programme. This reduces the moisture content in the laundry.
- Always dry a full load; this optimizes the relative energy consumption.

ADAPTING THE DRYER TO WATER CONDUCTIVITY

The drying results are affected by the conductivity of the water used during washing. If, by modifying the available dryness levels (iron dry; cupboard dry; extra dry), you are not satisfied with the final drying results, you can adapt the water conductivity level. The dryer comes with preset level 2. Choose between level 1 (most damp results) and 5 (most dry results).

Refer to section OPTIONS, FUNCTIONS AND INDICATORS / Settings.

PROGRAMMES

Make sure that your laundry is suitable to be treated in a tumble dryer. Refer to HINTS AND TIPS / Care labels.

ECO COTTON

For drying normally wet cotton laundry. Standard cotton programme, suitable to dry normally wet cotton laundry. Most efficient programme in terms of energy consumption for drying cotton laundry. The values on the Energy Label are based on this programme.



COTTON

For drying cotton laundry.



MIXED

For drying mixed laundry made of cotton, linen, artificial fibres and their blends.



SYNTHETICS

For drying laundry made of synthetic fibres.



DELICATES

For drying delicate laundry which needs gentle treatment.



WOOL EXCELLENCE

For drying woollens labeled with the Woolmark TOTAL EASY CARE WOOL.



JEANS

For drying cotton jeans-wear and garments made of robust jeans like material, such as trousers and jackets.



BIG ITEMS

For drying big laundry items, such as bathmats, blankets etc.



AIRING

For airing, refreshing and loosening up laundry for 30 minutes, without heating.



STEAM REFRESH

For refreshing laundry with steam.



Specifically designed to refresh and remove odors from dry and clean casual garments like shirts, blouses, trousers made out of cotton, synthetics and their blends.

Before loading the laundry into the drum, slightly humidify it by spraying it with water (maximum 200 ml; use a water spray bottle). For this programme, dryness level "cupboard dry" is preset and cannot be changed.

After programme end, the garments shall be removed immediately and put on clothes hangers to minimize wrinkling.

DRYING TIME

Time-restricted drying programme. Select programme duration by option Drying time.



For all fabrics appropriate for tumble drying. Suitable to add an additional short drying phase after programme end. Refer to OPTIONS, FUNCTIONS AND INDICATORS / option Drying time for more information.

SPECIAL PROGRAMMES

To set one of the following programmes, select and confirm the special programmes position. Then turn the knob to select one of the following programmes; the display indicates the programme name. Confirm the desired programme by pressing the knob.



Shirts

Gentle drying of shirts and blouses made of cotton, synthetic fibers or their blends.

Towels

For drying robust laundry made of cotton, such as terry towels.

Silk

Gentle drying of silk garments.

Sport

For drying sports garments made of synthetics or cotton.

Outdoor

For drying outdoor clothes which are appropriate for being treated in a dryer.

Downjackets

For drying big single items such as down jackets.

Miniload

Economic drying of small laundry loads.

OPTIONS, FUNCTIONS AND INDICATORS

Not all options are combinable; the non-combinable option switches off automatically.

OPTIONS which are directly selectable by pressing the respective button:

Steam option

Minimizes creasing of garments made of cotton, synthetics and their blends by adding a humidifying phase at the end of the drying cycle.

Use the option with small loads only, unload the garments from the dryer immediately after programme end and put them on clothes hangers.

The humidity level automatically adjusts to "cupboard dry" and cannot be changed with this option.



Drying time

To adjust the desired Drying time if drying time or Airing programme has been selected.

Press the button; the light goes on, and the drying time symbol on the display lights up. Turn the knob to select the desired drying time up to maximum 180 minutes, then press the knob to confirm.



Dryness level

To select the desired dryness level for the laundry load.

Press the button until it lights up. Turn the knob to select the desired dryness level; chose between



iron dry (suitable to be ironed after the drying cycle, therefore still slightly humid)



cupboard dry (dry enough to be put in a cupboard at the end of the drying cycle)



extra dry (maximum dryness level)

and confirm by pressing the knob.



OPTIONS which are selectable with the Options button

Fresh Care

Helps to keep your laundry fresh if you cannot unload it soon after programme end.

The dryer starts to tumble the laundry periodically a few minutes after programme end. This tumbling will last up to approximately 12 hours after end of the programme. You can stop it at any time by switching off the dryer with the On/Off button.



Gentle

Enables a more gentle treatment of the laundry by reducing the drying temperature.



Rapid

Enables quicker drying.



FUNCTIONS:

Settings

The following settings can be changed / selected:

- Display language / Key tones / Cycle end alert / Display contrast / Water conductivity (= adaptation to conductivity of water used for washing; adjustable from 1 = most damp results, to 5 = most dry results) / Remember last used cycle (if set to "Off", Eco Cotton is the default programme which is selected when switching on the dryer) / Eco mode (automatic switch-off function after programme end) / Return to factory settings.
- Press and hold the Settings button for at least 3 seconds.
- Turn the knob to select the setting which you want to change; confirm it by pressing the knob.
- Turn the knob to adjust the setting; confirm by pressing the knob.
- To exit the Settings mode, either turn the knob until the display indicates that you can exit – then confirm by pressing the knob. Or alternatively press the Settings button.



Key lock

To lock keys and knob of the control panel against unwanted operation.



To lock the keys:

- The dryer must be switched on.
- Press and hold the Key lock button until the button lights up. Knob and keys are locked now.



Only the On/Off button works

If you switch the dryer off and on again, the key lock remains active until you unlock it.



To unlock the keys:

- Press and hold the Key lock button until the button light goes off.

Finish in

Enables to have the laundry ready at a particular time by setting a delay until end of the programme.

Choose a delay up to 23 hours.

- Select programme and options.
- Press the "Finish in" button – the symbol over the button lights up.



- Turn the knob to select a delay up to 23 hours. Confirm the desired delay by pressing the knob.
- Press "Start / Pause" - the countdown of the delay starts. The display indicates that Finish in is active.
- The programme starts automatically, in time to be finished at the end of the delay period. On programme start, the delay on the display is replaced by the remaining programme duration.

To cancel the delay

- either press "Start/Pause" to cancel the delay. To start the selected programme immediately, press "Start/Pause" again .
- or press and hold "On/Off" to cancel the complete programme setting.

INDICATORS



Failure

For any failures, refer to section TROUBLESHOOTING in the USE AND CARE GUIDE.

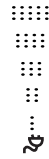

Energy monitor

Gives feedback about the energy consumption of the programme setting.

The less indicators light up, the more economic is your programme setting.

CARE AND MAINTENANCE

⚠ WARNING

Switch off and unplug the dryer before doing any cleaning and maintenance.

Caution, the water in the water tank can still be hot.

EMPTY WATER TANK AFTER EACH DRYING CYCLE

Hold the handle and carefully pull out the water tank. Hold the full water tank with both hands.
Empty the water and insert the container by pushing it back into place. Make sure that it is properly inserted.

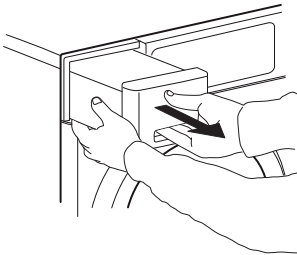

CLEAN DOOR FILTER AFTER EACH DRYING CYCLE

Open the door and remove the door filter by pulling it upwards.

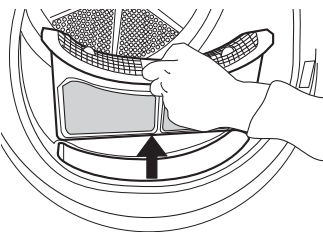

Press the button to open the door filter. Remove the lint inside. Close the filter and reinsert it in the right direction, so that it completely integrates in the filter chamber.

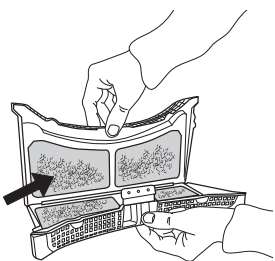

CLEAN THE BOTTOM FILTER AFTER ABOUT EVERY FIFTH DRYING CYCLE

Be Careful.

Some models are equipped with different filters, therefore some descriptions below may differ from the filter present in the dryer. All filters parts have to be cleaned

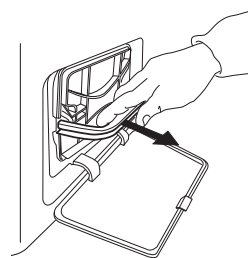

Open the bottom flap. Hold the handle and pull out the bottom filter.

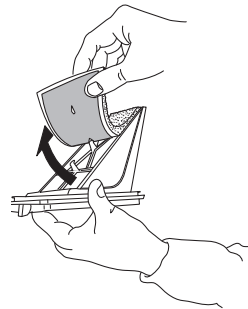

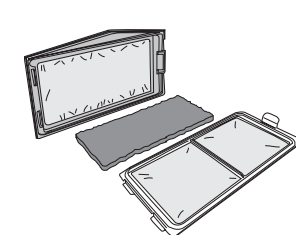

Remove the foam from the bottom filter, to clean it. Clean the filter foam and the filter by hand or under running water. Do not wash it in the washing machine. Wring out the filter foam. Do not insert it in the bottom filter dripping wet.

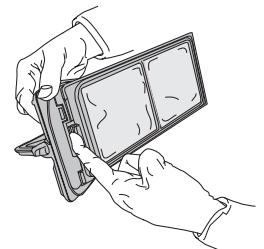

Fix the filter foam on the bottom filter. Clean the filter chamber of the dryer with a damp cloth or carefully with a vacuum cleaner. Insert the bottom filter again. Clap the filter handle down and close the bottom flap.



CONSUMPTION DATA

PROGRAMME	LOAD (KG)	SPIN SPEED (rpm)	HUMIDITY (%)	ENERGY CONSUMPTION (kWh)	DRYING TIME (min)
ECO COTTON 	8	1000	60	1.45	209
	4	1000	60	0.81	131
ECO COTTON 	8	800	70	1.67	234
	8	1400	50	1.23	167
COTTON IRON DRY	8	800	70	1.23	216
	8	1000	60	1.06	185
	8	1400	50	0.89	154
SYNTHETICS CUPBOARD DRY	3.5	1000	40	0.51	81

*Reference programmes for Energy Label / Regulation 392/2012 /EU Values are based on the default programme setting, with clean air and bottom filter. For consumer tests, the door filter and bottom filter need to be cleaned after each cycle.

The energy consumption and drying time may differ from the values above.

They depend on the operation conditions in your home (such as voltage fluctuation, mixture of textiles, humidity of the textiles after spinning, load volume).

The values are determined according to European Norm 61121 and refer to the default programme setting; changing the setting also impacts the consumption data.

HEAT PUMP SYSTEM

This dryer is fitted with a sealed heat pump system to dry your clothes. To operate, the heat pump contains fluorinated greenhouse gases (Fgases) which are covered by the Kyoto Protocol. These F gases are contained in a hermetically sealed unit. This sealed unit contains 0.33 kg of the F gas R134a which acts as a refrigerant. GWP = 1430 (1 t CO₂).

Power Consumption - Watts	
Left-on mode	1.07
Off-mode	0.40

PRODUCT FICHE

 [www](http://www.docs.whirlpool.eu) The product fiche with energy data of this appliance can be downloaded from Whirlpool Website docs.whirlpool.eu

HOW TO OBTAIN THE USE AND CARE GUIDE

>  [www](http://www.docs.whirlpool.eu) Download the Use and Care Guide from our website docs.whirlpool.eu (you can use this QR code), specifying the product's commercial code.

> Alternatively, contact our Client After-sales Service



CONTACTING OUR AFTER-SALES SERVICE

You can find our contact details in the warranty manual. When contacting our Client After-sales Service, please state the codes provided on your product's identification plate.

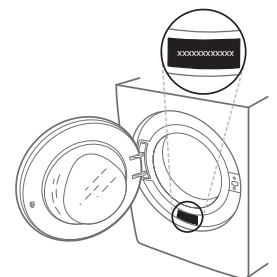

400011037633

Printed in Italy