

DAILY REFERENCE GUIDE



THANK YOU FOR PURCHASING AN INDESIT PRODUCT

To receive more comprehensive help and support, please register your product at www.whirlpool.eu/register



You can download the Safety Instructions and the Use and Care Guide by visiting our website docs.whirlpool.eu and following the instructions on the back of this booklet.



Before using the appliance carefully read the Health and Safety guide.

PRODUCT DESCRIPTION

APPLIANCE

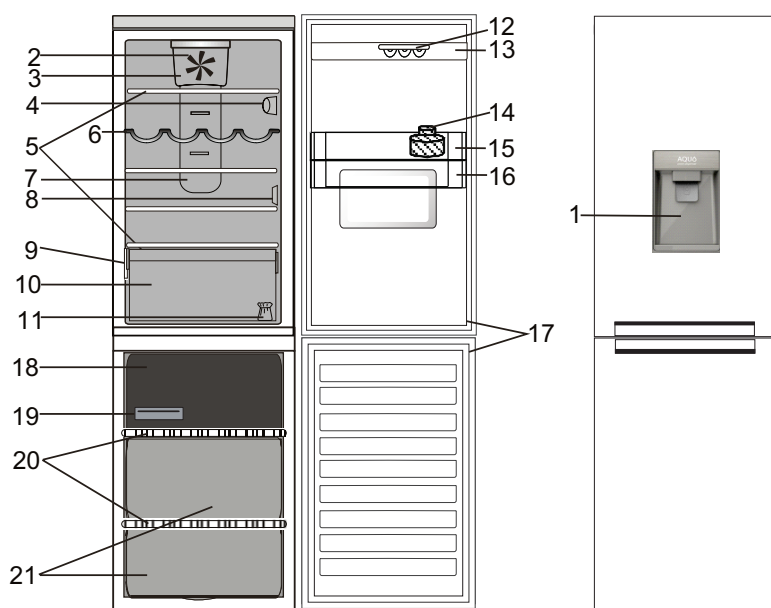

Refrigerator compartment

1. Dispenser's paddle
2. Fan
3. Fan cover and antibacterial filter area
4. Electronic control panel / light unit
5. Shelves
6. Bottle rack
7. Multi-flow cold air area
8. Sensor cover
9. Rating plate with commercial name
10. Fruits and vegetables crisper
11. Door reversibility kit
12. Egg tray
13. Door tray
14. Water filter
15. Aqua balcony
16. Aqua tank
17. Door seal

Freezer compartment

17. Door seal
18. Upper drawer: coolest zone best for freezing fresh food
19. Ice tray
20. Shelves
21. Freezer drawers

CONTROL PANEL

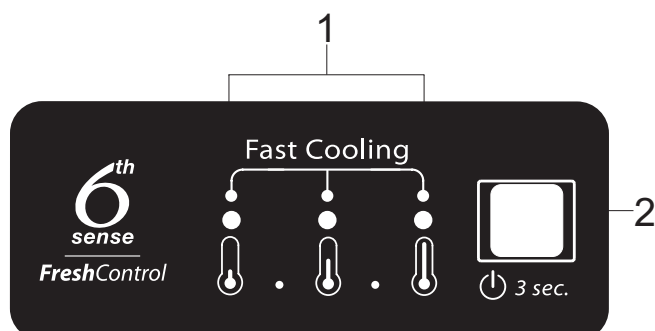

1. Indicator Leds (to display the current temperature setpoint or the Fast Cooling function)
2. On/Stand-By Button / Temperature Button

ACCESSORIES

EGG TRAY

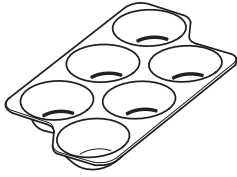

ICE TRAY

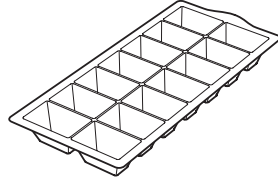

FIRST TIME USE

HOW TO START THE APPLIANCE

After plugging the appliance to the mains, it starts the operation automatically.
After starting the appliance, wait at least 4-6 hours before placing food into the fridge and into the freezer compartment.

When the appliance is connected to the power supply, the display lights up and all the icons appear on the display for approximately 1 second. The default (factory) values of the fridge compartment settings light-up.

DAILY USE

See Use and Care Guide for more details on functions / see last page for information on how to obtain the Use and Care Guide

FUNCTIONS

ON/STANDBY FUNCTION

To put the product in Stand-by, press and hold the On/Stand By button for 3 seconds. All the indicators turn off except On/Standby indicator.

Press again to reactivate the appliance.

TEMPERATURE SETTING

Press the Temperature button on the control panel to adjust the temperature from the warmest through the lower to the coldest level.

Pressing the Temperature button, the temperature setting will change cyclically.

At first plug-in of appliance temperature setpoint is present at medium position (factory setting).

Following table shows temperature setpoints:

○ ○ ●	HIGH TEMP.
○ ● ●	MED-HIGH TEMP.
○ ● ○	MEDIUM TEMP.
● ● ○	MED-LOW TEMP.
● ○ ○	LOW TEMP.
● ● ●	FAST COOLING



● Led on ○ Led off

Note: Displayed set points correspond to the average temperature throughout the whole refrigerator.

6TH SENSE FRESH CONTROL

This function automatically works to ensure the optimal conditions to preserve the stored food.

FAST COOLING FUNCTION

The use of the Fast Cooling function is recommended to increase the cooling/freezing capacity of the refrigerator/freezer compartment when placing a very high quantity of food within it.

To activate the Fast Cooling function, press the Temperature button cyclically on the control panel till all the 3 LEDs blink and remain on.



The function is automatically deactivated after 12 hours and return to previous selected set point.

The function can be manually deactivated by pressing the Temperature button on the control panel.

REFRIGERATOR LIGHT

The light system inside the refrigerator compartment uses LEDs light, allowing a better lightning as well as a very low energy consumption.

If the LED light system does not work, please contact the Service to replace it.

Important: The refrigerator compartment light switches on when the refrigerator door is opened. If the door is kept open for more then 4 minutes the light will be automatically switched off.

FAN + ANTIBACTERIAL FILTER

The Fan improves temperature distribution inside the refrigerator compartment, allowing better reservation of stored food.

If the appliance has the Fan it can be equipped with the antibacterial filter. Remove it from the box placed in the crisper drawer and insert into the fan cover - as in the picture.

The replacement procedure is included in the filter box.

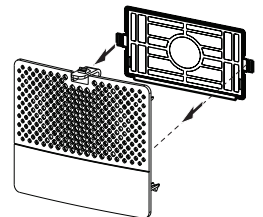

ALARM TABLE

ALARM TYPE	SIGNAL	CAUSE	CURE
Door open alarm.	Refrigerator Light blinks.	The door has remained open for more than 3 minutes.	Close the door.
Door open alarm.	Refrigerator Light OFF.	The door has remained open for more than 4 minutes.	Close the door.
Malfunction.	Any temperature indicators blink.	Product malfunction.	Contact the After-sales Service.

SOME OF THE FUNCTIONAL SOUNDS YOU MIGHT HEAR

A hissing sound when switching on the appliance for the first time or after a long pause.



A gurgling sound when refrigerant fluid enters into the pipes.



BRRR sound is from the compressor running.



Buzzing sound when water valve or fan start working.



A cracking sound when compressor starts.



The CLICK is from the thermostat which adjusts how often the compressor is running.



INSTALLATION OF THE WATER FILTER (ACTIVE CARBON)

The water filter is located inside the tank. This filter reduces the amount of chlorine, sediment, dirt, rust and cloudiness in the drinking water in the container located inside the tank. The filter must be installed in bottle balcony following the instructions contained in the water filter box. The filter is removable.

WATER FILTER

The water filter use an active carbon cartridge that reduces the amount of chlorine, sediments, dirt, rust and cloudiness in the drinking water. The filter must be installed in the bottle balcony. It is removable.

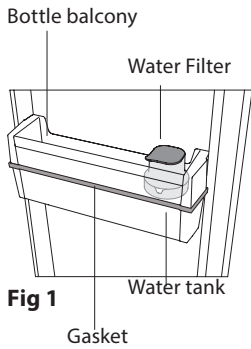

Fig 1

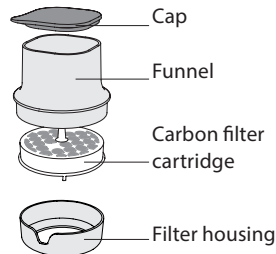

Fig 2

- Remove the filter from the balcony (**Fig. 4**);
- Remove the funnel from the filter housing rotating it anticlockwise (**Fig 5. a - b**).

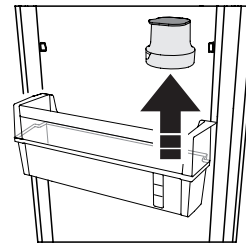

Fig 4

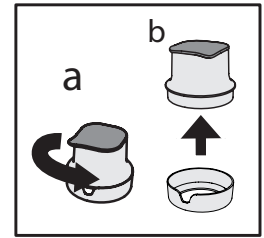

Fig 5

After activated, insert the carbon cartridge in the filter housing with the current month facing through the window (eg. If you are in october, face Oct month in the window) - See Fig. 6.

CARBON CARTRIDGE ACTIVATION

Before to use filter, the **CARBON FILTER CARTRIDGE must be activated and installed.** Remove the carbon filter from the packaging (which you can find in fruits and vegetables crisper) and activate it in this way;

1. submerge underwater for 10 minutes;
2. remove it from water and shake it vigorously for 10 seconds to activate.

FILTER INSTALLATION

Remove filter from balcony and open it to insert the carbon cartridge:

- Unlock the whole filter turning it anticlockwise (**Fig 3**);

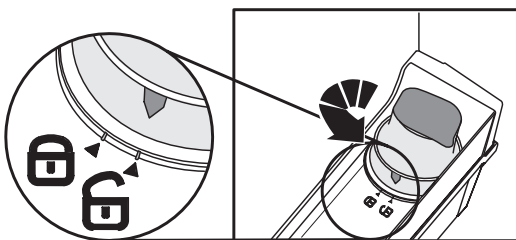

Fig 3

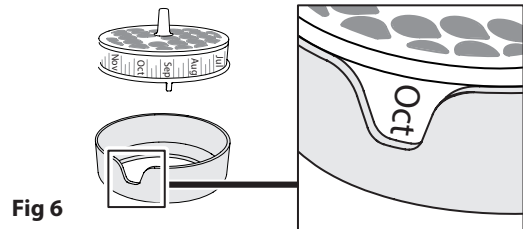

Fig 6

Close the filter (**Fig. 7**):

- a) insert the funnel on filter housing (with carbon filter in), as shown in **Fig. 7a**;
- b) rotate the funnel clockwise to fix it, as shown in **Fig. 7b**.

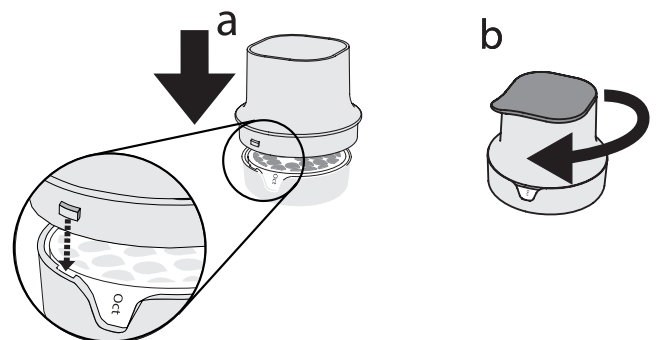

Fig 7

Then place the whole filter in the bottle balcony and lock it following the sequence in Fig 8.

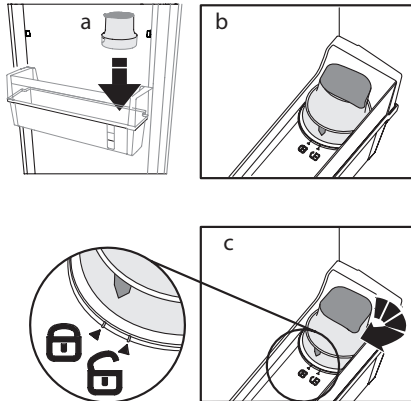

Fig 8

FILLING AND FILTERING WATER

Remove the cap and pour water into the funnel (Fig. 9): the water fill will be filtered and will fill the water tank. You can fill up to 3 litres. Don't overfill water (the max water level is indicated on the tank).

Note: fill water only in the tank. Do not insert juice, coke or other drink because they can damage the filter and the dispenser functionality.

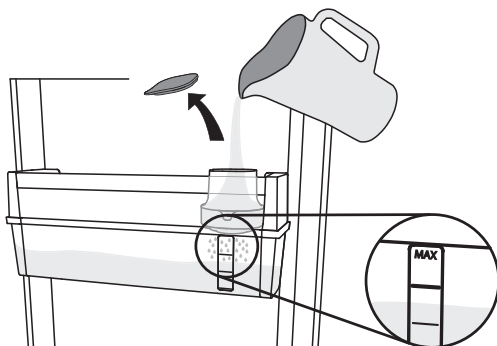

Fig 9

DISPENSING WATER

To dispense water press the paddle with a glass (Fig. 10) and release the paddle to stop dispensing.

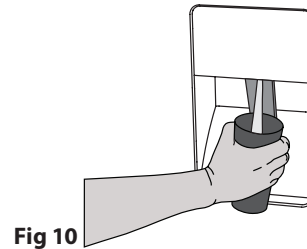

Fig 10

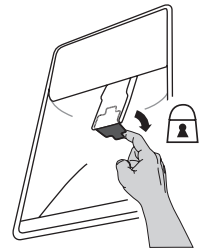

Fig 11

Note: possible black dots in the filtered water or in filter area are normal and not dangerous, they are due the normal carbon filter functionality.

DISPENSER CHILD LOCK: You can lock the dispenser's paddle to avoid children dispensing water (flip the small lever behind the paddle as shown in (Fig. 11).

REPLACING THE CARBON CARTRIDGE

The carbon filter lasts max 2 months for continuous use (up to 225 lt).

To replace the carbon cartridge:

- unlock the filter and remove it from the balcony;
- remove the funnel from filter housing rotating it anticlockwise;
- remove the old carbon cartridge and insert the new one after activated, with current month faced in the window). (You can follow the procedure described in Carbon filter activation and Filter installation - Fig. 3, 4, 5, 6, 7, 8).

CLEAN THE TANK

It is suggested to periodically remove the tank to clean it (see Fig 12 and description below):

- unlock the filter (a) and remove it (b);
- remove the bottle balcony (c) then remove the tank (d) and the gasket.

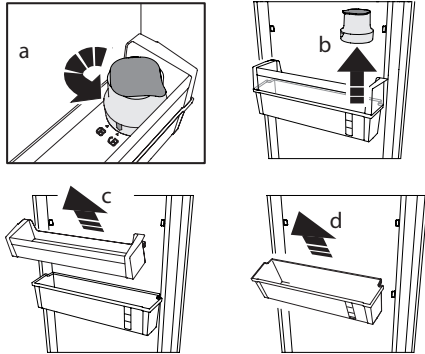

Fig 12

In case you decide to remove completely the water filter and tank from your fridge, you can remove the whole filter and the tank, using the balcony to normally store water bottles. In this case please use the filter cap to cover the hole on the balcony (see Fig. 13).

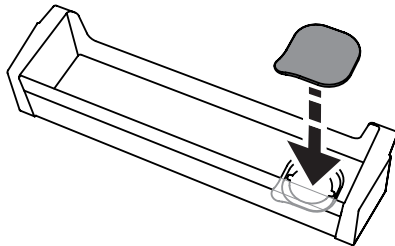

Fig 13

Wash the tank and the gasket with water only. At the end of cleaning, mount the gasket on the water tank. Make sure to correctly assembly the gasket on the tank (see Fig. 14).

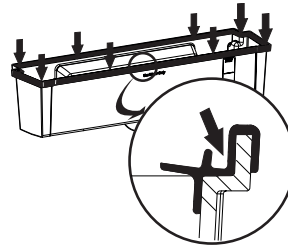

Fig 14

Then mount the bottle balcony on the water tank and assembly them on the door as suggested in Fig 15. Once assembled, mount the filter with the carbon cartridge (as described in Fig 5, 6, 7, 8).

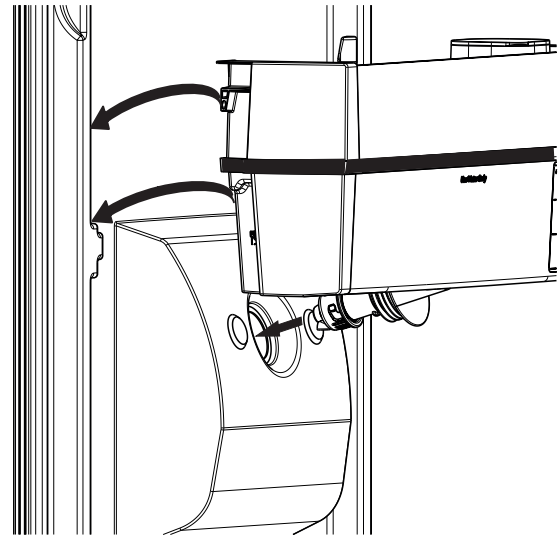
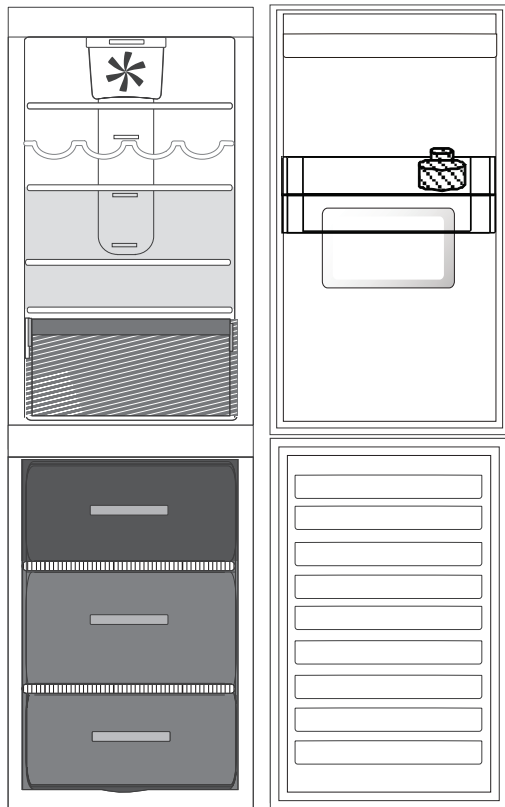

Fig 15

TROUBLESHOOTING GUIDE

Problem	Possible Cause	Solution
THE APPLIANCE IS NOT WORKING	There may be an appliance power supply problem.	<ul style="list-style-type: none"> › Check if power cable plugged into a live socket with the proper voltage. › Check if the protection devices and fuses of the electrical system in your home.
THERE IS WATER IN THE DEFROST PAN	This is normal in hot, damp weather. The pan can even be half full.	<ul style="list-style-type: none"> › Make sure the appliance is level so that the water does not overflow.
THE EDGES OF THE APPLIANCE CABINET, WHICH COME IN CONTACT WITH THE DOOR SEAL, ARE WARM TO THE TOUCH	This is not a defect. This is normal in hot weather and when the compressor is running.	
THE LIGHT DOES NOT WORK	The light may need replacing. The appliance may be in On/Stand-by model	<ul style="list-style-type: none"> › Make sure if the protection devices and fuses of the electrical system in your home work well. › Check if the power cable is plugged into a live socket with the proper voltage. › In case the LEDs are broken the user must call the Service for exchange of the same type available only at our After-sales Service Centers or authorized dealers.
THE MOTOR SEEMS TO RUN TOO MUCH	Motor running time depends on different things: number of door openings, amount of food stored, temperature of the room, setting of the temperature controls.	<ul style="list-style-type: none"> › Make sure that the appliance controls are correctly set. › Check if there is not a large amount of food been added to the appliance. › Check that the door is not opened too often. › Check that the door close properly.
THE APPLIANCE TEMPERATURE IS TOO HIGH	There could be various causes (see "Solutions").	<ul style="list-style-type: none"> › Make sure that the condenser (back the appliance) is free of dust and fluff. › Make sure that the door properly closed. › Make sure that the door seals properly fitted. › On hot days or if the room is warm, the motor naturally runs longer. › If the appliance door has been left open for a while or if large amounts of food have been stored, the motor will run longer in order to cool down the interior of the appliance.
THE DOORS DO NOT OPEN AND CLOSE PROPERLY	There could be various causes (see "Solutions").	<ul style="list-style-type: none"> › Check that food packages are not blocking the door. › Check that the internal parts or automatic ice maker are not out of position. › Check that the door seals are not dirty or sticky. › Ensure the appliance is level.

HOW TO STORE FOOD AND BEVERAGE



Legend



TEMPERATE ZONE

Suggested for the storage of tropical fruit, cans, drinks, eggs, sauces, pickles, butter, jam



COOL ZONE

Suggested for storage of cheese, milk, dairy food, delicatessen, yogurt, cold cuts, desserts



FRUIT & VEGETABLE DRAWER



FREEZING ZONE DRAWER

(MAX COOL ZONE) Suggested to freeze fresh/cooked food



NORMAL FREEZER DRAWERS

Note: The Grey tone of the legend doesn't match with the color of drawers

FRIDGE COMPARTMENT

Use recyclable plastic, metal, aluminum and glass containers and cling film to wrap foods.

Always use closed containers for liquids and for food that may give off or be tainted by odor or flavor transfer or cover them.

If you have a little quantity of food to store in the refrigerator, we recommend to use the shelves above the crisper for fruits and vegetables since this is the coolest area of the compartment.

Foods which give off a large amount ethylene gas and those that are sensitive to this gas, such as fruit, vegetables and salad, should always be separated or wrapped so as not to reduce the storage life; for example do not store tomatoes together with kiwi fruits or cabbage.

To avoid bottles falling over, you can use the bottle holder (available on selected models).

Do not store food too close together to enable sufficient air circulation.

FREEZER COMPARTMENT

The freezer is the ideal storage location for store frozen food, make ice cubes and freeze fresh food in the freezer compartment.

The maximum number of kilograms of fresh food that can be frozen within a 24-hour period is indicated on the rating plate (...kg/24h).

If you have a little quantity of food to store in the freezer, we recommend to use the upper area.

PRODUCT FICHE

The product fiche with energy data of this appliance can be downloaded from Indesit website docs.whirlpool.eu

HOW TO OBTAIN THE USE AND CARE GUIDE

Download the Use and Care Guide from our website docs.whirlpool.eu (you can use this QR Code), specifying the product's commercial code.

Alternatively, contact our Client After-sales Service.



CONTACTING OUR AFTER-SALES SERVICE

You can find our contact details in the warranty manual. When contacting our Client After-sales Service, please state the codes provided on your product's identification plate.

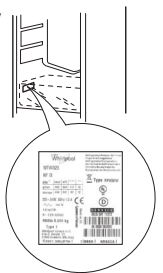

400010893555

Printed in Italy