

KitchenAid

POWER PLUS BLENDER

5KSB8270

PRODUCT GUIDE



W11499120A

PARTS AND FEATURES

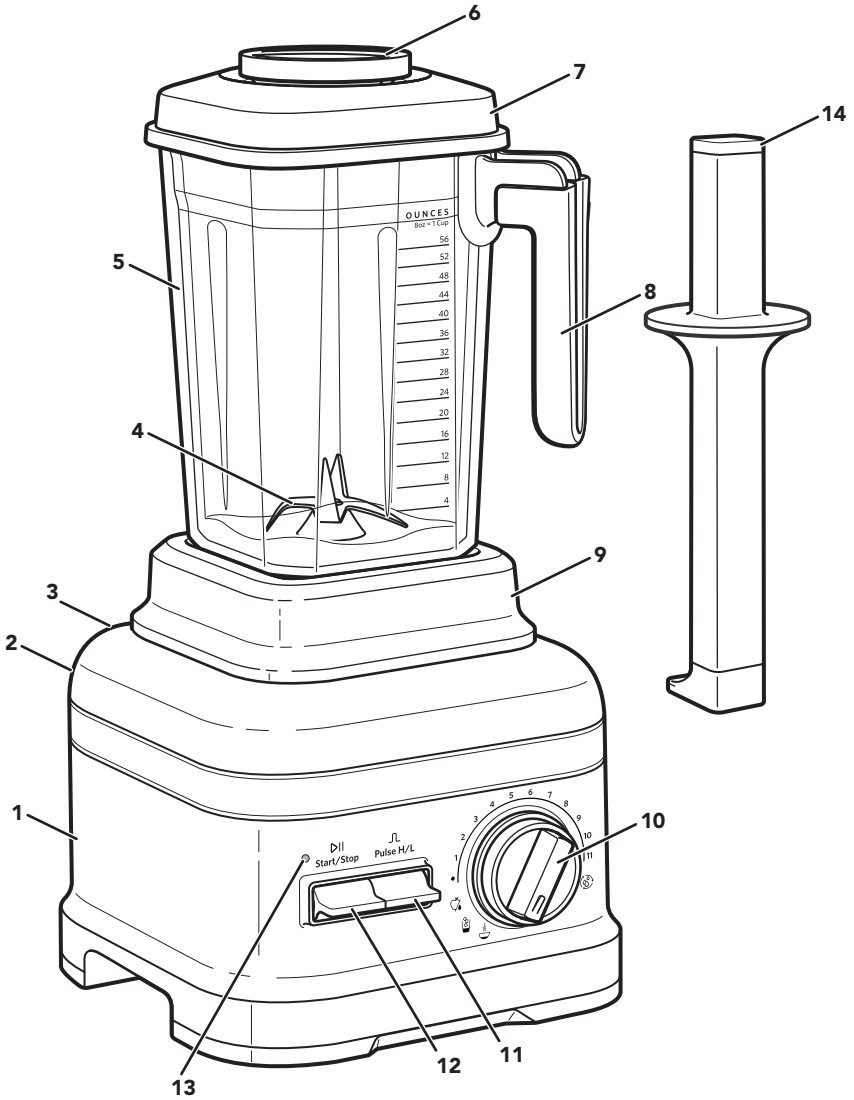

- 1. Base
- 2. Power Switch (not shown)
- 3. Detachable Power Cord (not shown)
- 4. Blade
- 5. Thermal Control Blender Jar
- 6. Lid
- 7. Ingredient-Measuring Cap
- 8. Jar Handle with Soft Touch Handle Grip
- 9. Removable Blender Jar Pad
- 10. Control Dial
- 11. Pulse Toggle Switch
- 12. Start/Stop Toggle Switch
- 13. Status Indicator Light
- 14. Flex Edge Tamper

PRODUCT SAFETY

Your safety and the safety of others are very important.

We have provided many important safety messages in this manual and on your appliance. Always read and obey all safety messages.



This is the safety alert symbol.

This symbol alerts you to potential hazards that can kill or hurt you and others.

All safety messages will follow the safety alert symbol and either the word "DANGER" or "WARNING." These words mean:

 **DANGER**

You can be killed or seriously injured if you don't immediately follow instructions.

 **WARNING**

You can be killed or seriously injured if you don't follow instructions.

All safety messages will tell you what the potential hazard is, tell you how to reduce the chance of injury, and tell you what can happen if the instructions are not followed.

IMPORTANT SAFEGUARDS

When using electrical appliances, basic safety precautions should always be followed, including the following:

1. Read all instructions. Misuse of appliance may result in personal injury.
2. To protect against risk of electrical shock, do not put Blender in water or other liquid.
3. This appliance is not intended for use by persons (including children) with reduced physical, sensory or mental capabilities, or lack of experience and knowledge, unless they have been given supervision or instruction concerning use of the appliance by a person responsible for their safety.
4. European Union Only: This appliance shall not be used by children. Keep the appliance and its Cord out of reach of children.
5. European Union Only: Appliances can be used by persons with reduced physical, sensory or mental capabilities or lack of experience and knowledge if they have been given supervision or instruction concerning use of the appliance in a safe way and understand the hazards involved. Children shall not play with the appliance.
6. Children should be supervised to ensure they do not play with the appliance.
7. Avoid contacting moving parts. Keep hands, hair, clothing, as well as spatulas and other utensils away from Blade during operation to reduce the risk of injury to persons and/or damage to the Blender.
8. Turn the appliance OFF (0), then unplug from the outlet when not in use, before assembling or disassembling parts and before cleaning. To unplug, grasp the plug and pull from the outlet. Never pull from the Power Cord.

9. Do not operate any appliance with a damaged cord or plug, or after the appliance malfunctions, or is dropped or damaged in any manner. Return appliance to the nearest Authorised Service Facility for examination, repair, or electrical or mechanical adjustment.
10. If the Supply Cord is damaged, it must be replaced by the manufacturer, its service agent or similarly qualified persons in order to avoid a hazard.
11. Do not let Cord hang over edge of table or counter.
12. Do not let the Cord contact hot surfaces, including the stove.
13. Blades are sharp. Care should be taken when handling the sharp cutting Blades, emptying the jar, and during cleaning.
14. Flashing light indicates ready to operate - avoid any contact with Blades or moveable parts.
15. When blending hot liquids or ingredients, Ingredient-Measuring Cap should remain in place over the Lid opening. Always start on lowest speed and slowly ramp to desired speed when blending hot liquids or ingredients.
16. Keep hands and utensils out of jar while blending to reduce the risk of severe injury to persons or damage to the Blender. A scraper may be used but must be used only when the Blender is not running.
17. Do not use the Blender outdoors.
18. Never leave the appliance unattended while it is in operation.
19. Be careful if hot liquid is poured into the Blender as it can be ejected out of the appliance due to sudden steaming.
20. Always operate Blender with Lid in place.
21. The use of accessories/attachments not recommended by the appliance manufacturer may result in fire, electric shock or injury to persons.
22. Allow the appliance to cool completely before putting on or taking off parts, and before cleaning the appliance.
23. Refer to the "Care and Cleaning" section for instructions on cleaning the surfaces in contact with food.
24. This appliance is intended to be used in household and similar applications such as:
 - staff kitchen areas in shops, offices and other working environments;
 - farmhouses;
 - by clients in hotels, motels and other residential type environments;
 - bed and breakfast type environments.

SAVE THESE INSTRUCTIONS

For complete details on product information, instructions and videos, including Guarantee information, visit www.KitchenAid.co.uk or www.KitchenAid.eu. This may save you the cost of a service call. To receive a free printed copy of the information online, call **00 800 381 040 26**.

ELECTRICAL REQUIREMENTS

⚠ WARNING



Electrical Shock Hazard

Plug into an earthed outlet.

Do not remove earth prong.

Do not use an adapter.

Do not use an extension cord.

Failure to follow these instructions can result in death, fire, or electrical shock.

Voltage: 220-240 V

Frequency: 50-60 Hz

Power (Wattage): 1800 W

NOTE: If the plug does not fit in the outlet, contact a qualified electrician. Do not modify the plug in any way. Do not use an adapter.

Do not use an extension cord. If the power supply Cord is too short, have a qualified electrician or service technician install an outlet near the appliance.

MOTOR HORSEPOWER





Motor horsepower for the Blender motor was measured using a dynamometer, a machine that laboratories routinely use to measure the mechanical power of motors. Our 3.0 peak horsepower (HP) motor reference reflects the horsepower output of the motor itself and not the Blender's horsepower output in the Blender pitcher. As with any Blender, the power output in the pitcher is not the same as the horsepower of the motor itself. This motor delivers 2.54 peak HP in the pitcher, enabling your Blender to deliver robust power for all your recipes.

BLENDER FUNCTION GUIDE

The Blender has three Preset Recipe Programs: Juice, Smoothies, and Soups. It also features Variable Speed and Pulse functions that allow you to customize your blending for any recipe you make.

The three Preset Recipe Programs were each developed based on typical recipes of that kind. You might find that not all recipes are exactly the same, and sometimes a recipe might blend more to your preference on a program that is not obvious. For example, when making a smoothie, you may prefer the finer texture that the Juice program creates. We encourage you to experiment to find the best program for your favourite recipes.

SETTING	DESCRIPTION	BLENDING TIME (in min:sec)	SUGGESTED ITEMS TO BLEND	
JUICE 	Several variations of speed to best capture whole fruits or vegetables to liquefy contents. Slower speeds at conclusion of cycle to settle ingredients and reduce froth.	1:10	Fruits	Vegetables

SETTING	DESCRIPTION	BLENDING TIME (in min:sec)	SUGGESTED ITEMS TO BLEND	
SMOOTHIES 	Gradually ramp up to full power to completely blend hard foods such as ice, whole fruits or vegetables, or frozen fruits.	0:40	Blended ice drinks Crushed ice Whole fruits and vegetables	Frozen chopped fruit (defrost slightly until it can be probed with a knife tip) Seeds
SOUPS* 	Heat your soup from room temperature ingredients. Gradually ramps up to high speed to allow for contents to fall into the Blade for a complete blend. Slow speeds at the end allow contents to settle and reduce froth.	5:00	Soup Vegetables	Broth Sauces
CLEANING 	Quick pulses of power and high speeds work to clean the Blender Jar by filling 1/3 of the jar with water and a drop of dish soap.	0:33	Water	Dish soap
PULSE 	Allow precise control of the duration and frequency of blending. Great for recipes that require a light touch. Alternatively, use Pulse during manual operation to add a boost of power momentarily.	0:00	Savoury crumb topping Sweet crumb topping Meat salad for sandwich filling	Chopped fruits Chopped vegetables Ice crush
VARIABLE SPEEDS	Manual speeds offer ultimate control of the Blender. Allows for fine-tuned chopping and blending needs to prepare any recipe.	0:00 - 6:00	Fruits Vegetables Nuts Dips Frozen desserts	Soups Sauces Doughs Butters

*If blending pre-heated ingredients, use variable speed and run for 1-2 minutes. Start on a low speed and ramp up to the speed desired. The soup setting is designed to heat cooled or room-temperature ingredients, and is not intended for pre-heated ingredients.

PRODUCT ASSEMBLY

PREPARING THE BLENDER FOR USE

⚠ WARNING



Electrical Shock Hazard

Plug into an earthed outlet.

Do not remove earth prong.

Do not use an adapter.

Do not use an extension cord.

Failure to follow these instructions can result in death, fire, or electrical shock.

Before first use

Before using your Blender for the first time, wipe the Blender Base with a warm, damp cloth, then wipe clean with a damp cloth. Dry with a soft cloth. Wash the Blender Jar, Lid, Flex Edge Tamper, and Ingredient-Measuring Cap in warm, sudsy water (see the “Care and Cleaning” section). Rinse parts and wipe dry.

PRODUCT USAGE

1. Put the items to blend into the Blender Jar. Add liquids first, then soft foods, then leafy greens, and ice or frozen items last.

1. Before using the Blender, be sure the countertop beneath the Blender and surrounding areas are dry and clean. Then, plug the Blender into an earthed outlet.

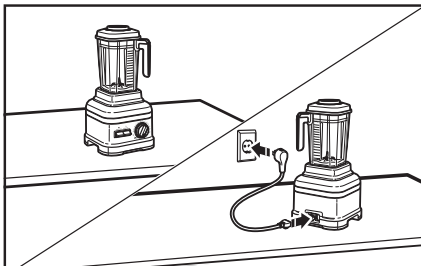

2. The main Power Switch is on the back of the Blender Base. Flip the Power Switch to the On position. The Status Indicator Light above the **Start/ Stop Toggle Switch** will begin to flash, indicating that the Blender is in Standby mode. The Blender is now ready to operate.

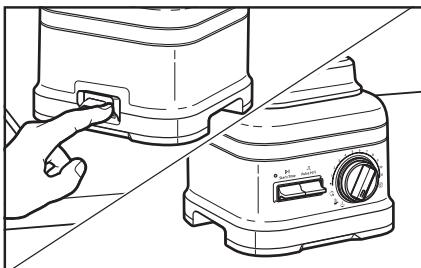

2. Make sure that the Lid is fully secured on the Blender Jar. Next, place the Blender Jar on the Base, making sure that it is fully aligned on the Jar Pad.

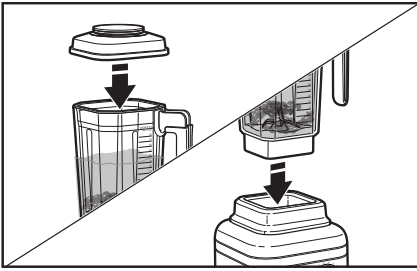

NOTE: Do not fill the Blender Jar beyond the “max fill” line, especially when blending liquids.

3. Flip the **Start/ Stop** Toggle Switch up or down to begin operation of the Blender. The Status Indicator Light will now be solid.

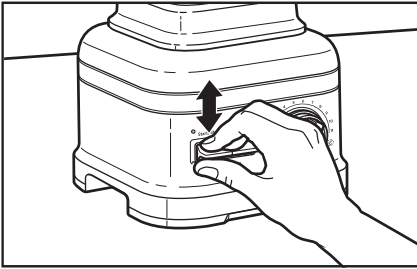

4. Turn the Control Dial to your desired speed or program. See the “Blender Function Guide” for more information.

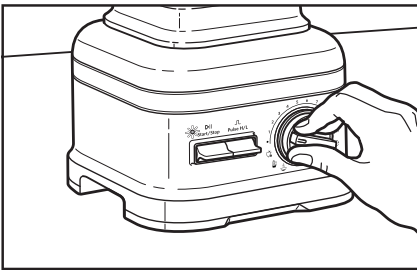

NOTE: If you select a pre-programmed cycle, you will need to flip the **Start/ Stop** Toggle Switch to begin operation. The Blender will automatically stop running once the cycle is complete.

5. Utilize the Flex Edge Tamper* accessory as needed for optimal blending performance. Remove the Ingredient-Measuring Cap only, and leave the Lid in place. Stir or press contents down towards the Blade. When you are finished, replace the Ingredient-Measuring Cap to the Blender Jar.

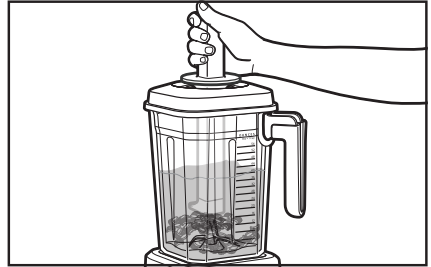

6. If desired, use the Pulse function for a momentary boost of speed while blending on the variable speed settings.

Press and hold the **Pulse** Toggle Switch up for a faster pulse, or down for a slower pulse.

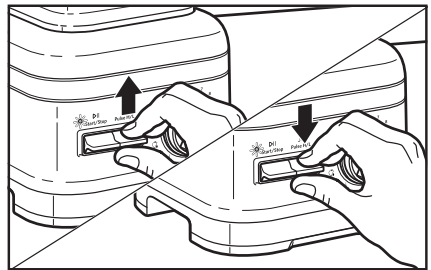

NOTE: The Pulse function may also be used on its own as a separate blending function while the Blender is in Standby mode. Pulse is not available when running a preset program.

*Use the Tamper only when the Blender does not function.

7. After blending, flip the **Start/Stop** Toggle Switch up or down. Allow the Blender to come to a complete stop before removing the Lid and pouring your blended ingredients.

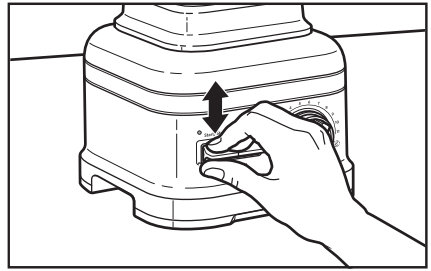

CARE AND CLEANING

CLEANING THE BLENDER AND ACCESSORIES

Clean the Blender thoroughly after every use.

NOTE: Allow the appliance to cool completely before putting on or taking off parts, and before cleaning the appliance. To avoid damaging the Blender, do not immerse the Blender Base or Cord in water. To avoid scratching the Blender, do not use abrasive cleansers or scouring pads.

1. To clean the Blender Base and Cord: Unplug the Blender before cleaning. Wipe the Base and the Cord with a warm, damp, soapy cloth; wipe clean with a damp cloth, and dry with a soft cloth.

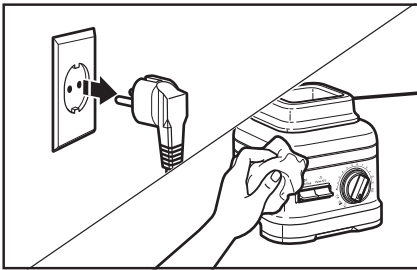

2. Make sure to clean the Blender Jar, Lid, and Ingredient-Measuring Cap after each use. Remove any remaining contents from the Blender Jar. Fill 1/3 of the Blender Jar with warm water and add 1 drop of liquid detergent. Place the Lid on the Blender Jar, and make sure the Blender Jar is fully in place on the Blender Base.

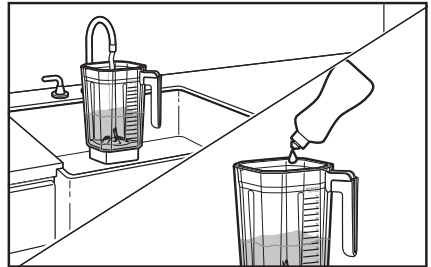

3. Rotate the Control Dial to 30 seconds. Flip the **Start/Stop** Toggle Switch up or down. When the timer finishes, pour out the soapy water and rinse the Blender Jar with warm water.

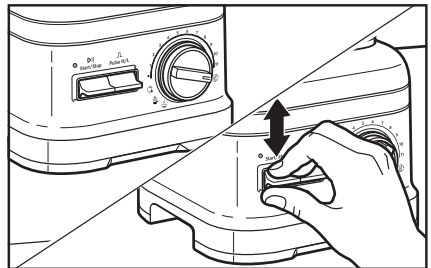

4. The Blender Jar, Lid, Flex Edge Tamper, and Ingredient-Measuring Cap are dishwasher-safe; the Flex Edge Tamper, Lid, and Ingredient-Measuring Cap should be placed in the top rack of the dishwasher. If preferred, all parts may also be washed by hand with a damp cloth and warm soapy water, and then rinsed with warm water and dried with a soft cloth.

NOTE: The Handle Grip can remain on the Handle of the Blender Jar during cleaning and dishwasher cycles. If needed, the Handle Grip can be removed to run through the dishwasher separately, and then replaced.

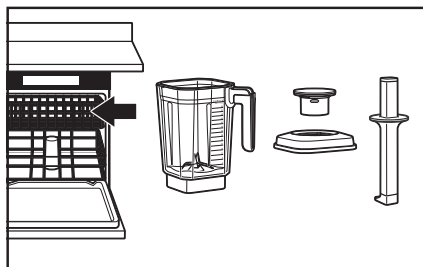

TROUBLESHOOTING GUIDE

⚠ WARNING

Electrical Shock Hazard



Plug into an earthed outlet.

Do not remove earth prong.

Do not use an adapter.

Do not use an extension cord.

Failure to follow these instructions can result in death, fire, or electrical shock.

PROBLEM

When the Blender is plugged in and the main power On/Off Toggle Switch is on, the Blender will go into Standby mode (flashing white Indicator Light). However, after 10 minutes of no activity the Blender will go into Sleep mode and the Indicator Light will turn off:

SOLUTION

To wake up the Blender, simply flip the **▷|| (Start/Stop)** Toggle Switch up or down. This will put the Blender back into Standby mode.

PROBLEM	SOLUTION
<p>If the Status Indicator Light flashes an orange colour, the Blender is in error mode. This can be caused by using a spatula in the Blender Jar that locks up the Blade or having an ice cube or hard food in a location that locks up the Blade:</p>	<p>Correct the problem by turning OFF (0) the Blender using the dedicated off switch in the back, or by unplugging the Blender. Remove the Blender Jar from the Base, and clear the items. Place the Blender Jar back on the Base, and then turn the Blender back on to continue regular use.</p>
<p>If the Blender stops while blending:</p>	<p>After 6 minutes of run time, the Blender will automatically shut off and go into Sleep mode, and the LED light will turn off. You can wake the Blender back up using the Toggle Switches (Start/Stop or Pulse High/Pulse Low). If the Blender stops in less than 6 minutes, it is possible there is an internal error with the Blender.</p>
<p>If the ingredients of a recipe aren't blending:</p>	<p>There may be times when an air pocket is created around the Blade, causing the ingredients to miss the blending Blade. Use your Flex Edge Tamper to assist during the blend by pushing ingredients into the Blade, or stir to move ingredients around the Blender Jar. If that does not work, stop the Blender, remove the Blender Jar from the Base, and use a spatula to rearrange ingredients in the Blender Jar. For certain recipes, try adding more liquid.</p>
<p>If you experience an overflow from the Blender Jar:</p>	<p>Unplug the Blender. Remove the Jar and Jar Pad. Clean the Blender housing, Jar Pad, and exterior of the Jar. Dry each part thoroughly, and then reinstall the Jar Pad.</p>
	<p>If the overflow is on or over the Control Dial, it can be removed by gently and firmly pulling it off. After cleaning and drying, reinstall the knob. To avoid damage to the graphics, do not apply too much force or use abrasive cleansers.</p>
<p>If the problem cannot be corrected:</p>	<p>See the "Terms of KitchenAid Guarantee ("Guarantee")" sections. Do not return the Blender to the retailer; retailers do not provide service.</p>

ELECTRICAL EQUIPMENT WASTE DISPOSAL

DISPOSAL OF PACKING MATERIAL

The packing material is recyclable and is marked with the recycle symbol ♻️. The various parts of the packing must therefore be disposed of responsibly and in full compliance with local authority regulations governing waste disposal.

RECYCLING THE PRODUCT

- This appliance is marked in compliance with law in the EU and UK covering, Waste Electrical and Electronic Equipment (WEEE).
- By ensuring this product is disposed of correctly, you will help prevent potential negative consequences for the environment and human health, which could otherwise be caused by inappropriate waste handling of this product.
- The symbol  on the product or on the accompanying documentation indicates that it should not be treated as domestic waste but must be taken to an appropriate collection centre for the recycling of electrical and electronic equipment.

For more detailed information about treatment, recovery and recycling of this product, please contact your local city office, your household waste disposal service or the shop where you purchased the product.

DECLARATION OF CONFORMITY

FOR UNITED KINGDOM

This appliance has been designed, constructed and distributed in compliance with the safety requirements of UK Legislation: Electrical Equipment (Safety) Regulations 2016, Electromagnetic Compatibility Regulations 2016. The Ecodesign for Energy-Related Products and Energy Information (Amendment) (EU Exit) Regulations 2019. The Restriction of the Use of Certain Hazardous Substances in Electrical and Electronic Equipment Regulations 2012.

FOR EUROPEAN UNION

This appliance has been designed, constructed, and distributed in compliance with the safety requirements of EC Directives: Low Voltage Directive 2014/35/EU, Electromagnetic Compatibility Directive 2014/30/EU, Ecodesign Directive 2009/125/EC, RoHS Directive 2011/65/EU and following amendments.

TERMS OF KITCHENAID GUARANTEE ("GUARANTEE")

Covering U.K. - Ireland - South Africa - UAE

KitchenAid Europa, Inc., Nijverheidslaan 3, Box 5, 1853 Strombeek-Bever, Belgium ("Guarantor") grants the end-customer, who is a consumer, a Guarantee pursuant to the following terms.

FOR U.K.:

The Guarantee applies in addition to and does not limit or affect the statutory warranty rights of the end-customer against the seller of the product. In summary, the Consumer Rights Act 2015 says products must be as described, fit for purpose and of satisfactory quality. During the expected lifespan of your product your legal rights entitle you to the following:

- Up to 30 days: if your product is faulty, then you can get an immediate refund.
- Up to six months: if your product can't be repaired or replaced, then you're entitled to a full refund, in most cases.
- Up to six years: if your product does not last a reasonable length of time you may be entitled to some money back.

These rights are subject to certain exceptions. For detailed information please visit the Citizens Advice website www.adviceguide.org.uk or call **03454 04 05 06**.

FOR IRELAND:

The Guarantee applies in addition to and does not limit or affect the statutory warranty rights of the end-customer against the seller of the product under the European Communities (Certain Aspects of the Sale of Consumer Goods and Associated Guarantees Regulations 2003 (S.I. No. 11/2003)) and other enactments governing the sale of consumer goods.

FOR SOUTH AFRICA:

The Guarantee applies in addition to and does not limit or affect the statutory warranty rights of the end-customer against the seller of the product. In summary, the Consumer Protection Act, 2008 says that products must be: (i) reasonably suitable for the purpose for which they are intended; (ii) in good working order, of good quality and free of any defects; (iii) useable and durable for a reasonable period of time, having regard to the use to which they would normally be put and to all the surrounding circumstances; and (iv) in compliance with any applicable standards or any other public regulations.

During the expected lifespan of your product and where the products are not purchased online, your legal rights will entitle you to the following:

- You will be entitled to a full refund, if you did not have the opportunity to examine the product before delivery and if you rejected delivery of the product on the basis that the type and quality of the product was not as reasonably expected or did not reasonably conform to the material specifications.
- Within 5 business days after delivery: you may rescind your purchase and request a refund, if your purchase resulted from direct marketing.
- Within 10 business days after delivery: you will be entitled to a full refund, if it is found that the product was unsuitable for a particular purpose specifically communicated to you by the Guarantor.
- Within 15 business days after delivery: you will be entitled to a refund if: (i) the product was not delivered to you; or (ii) if you returned the product to the Guarantor.
- Within 6 months after delivery: you will be entitled to a refund or a replacement product, if the product is defective or fails to operate in terms of its specifications.

Where you have purchased a product online your legal rights will be governed by the Electronic Communications and Transactions Act, 2002 and you will be entitled to the following:

- Within 7 days after conclusion of the transaction or after delivery: you may cancel your purchase without reason and without penalty.
- Within 30 days of the date of cancellation of the transaction: you will be entitled to receive a refund, if you have already made payment.
- You will only be liable for the direct costs of returning the product to the Guarantor.

FOR UAE:

The Guarantee applies in addition to and does not limit or affect the statutory warranty rights of the end-customer against the seller of the product.

1. SCOPE AND TERMS OF THE GUARANTEE

- a) The Guarantor grants the Guarantee for the products mentioned under Section 1.b) which a consumer has purchased from a seller or a company of the KitchenAid-Group within the following countries: U.K., Ireland, or South Africa, or the United Arab Emirates (UAE).
- b) The Guarantee period depends on the purchased product and is as follows:
Ten Year full guarantee from date of purchase.
- c) The Guarantee period commences on the date of purchase, i.e. the date on which a consumer purchased the product from a dealer or a company of the KitchenAid-Group.
- d) The Guarantee covers the defect-free nature of the product.
- e) The Guarantor shall provide the consumer with the following services under this Guarantee, at the choice of the Guarantor, if a defect occurs during the Guarantee period:
 - Repair of the defective product or product part, or
 - Replacement of the defective product or product part. If a product is no longer available, the Guarantor is entitled to exchange the product for a product of equal or higher value.
- f) If the consumer wishes to make a claim under the Guarantee, the consumer has to contact the country specific KitchenAid service centres or the Guarantor directly at KitchenAid Europa, Inc. Nijverheidslaan 3, Box 5, 1853 Strombeek-Bever, Belgium;

Email-Address U.K.: CONSUMERCARE.UK@kitchenaid.eu

Email-Address IRELAND: CONSUMERCARE.IE@kitchenaid.eu

Toll Free Number U.K. & IRELAND: **00 800 381 040 26**

FOR SOUTH-AFRICA:

Our local KitchenAid Distributor:

KitchenAid Africa
PO Box 52102
V&A Waterfront
Cape Town
8002

Contact our distributor:

Telephone: +27 21 555 0700

You can contact our Customer Service Centre for Small Domestic Appliances from 8.30 am to 1.00 pm and from 1.30 pm to 5.00 pm or write to us at the following address: hello@kitchenaidafrica.com

FOR UAE:

AL GHANDI ELECTRONICS.
POST BOX NO. 9098,
DUBAI, UNITED ARAB EMIRATES
Toll free number: +971 4 2570007

- g) The costs of repair, including spare parts, and any postage costs (if applicable) for the delivery of a defect-free product or product part shall be borne by the Guarantor. The Guarantor shall also bear the postage costs for returning the defective product or product part if the Guarantor or the country specific KitchenAid customer service centre requested the return of the defective product or product part. However, the consumer shall bear the costs of appropriate packaging for the return of the defective product or product part.
- h) To be able to make a claim under the Guarantee, the consumer must present the receipt or invoice of the purchase of the product.

2. LIMITATIONS OF THE GUARANTEE

- a) The Guarantee applies only to products used for private purposes and not for professional or commercial purposes.
- b) The Guarantee does not apply in the case of normal wear and tear, improper or abusive use, failure to follow the instructions for use, use of the product at the wrong electrical voltage, installation and operation in violation of the applicable electrical regulations, and use of force (e.g. blows).
- c) The Guarantee does not apply if the product has been modified or converted, e.g. conversions from 120 V products to 220-240 V products.
- d) The provision of Guarantee services does not extend the Guarantee period, nor does it initiate the commencement of a new Guarantee period. The Guarantee period for installed spare parts ends with the Guarantee period for the entire product.

e) FOR SOUTH-AFRICA & UAE ONLY:

Further or other claims, in particular claims for damages, are excluded unless liability is mandatory by law.

After expiry of the Guarantee period or for products for which the Guarantee does not apply, the KitchenAid customer service centres are still available to the end-customer for questions and information.

Further information is also available on our website:

- For U.K. & Ireland www.kitchenaid.eu
- For South-Africa: www.kitchenaidafrica.com
- For UAE: www.KitchenAid-MEA.com

PRODUCT REGISTRATION

Register your new KitchenAid appliance now: <http://www.kitchenaid.eu/register>

KitchenAid

©2021 All rights reserved.