

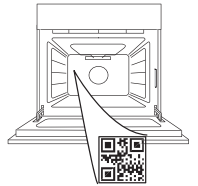

THANK YOU FOR BUYING AN INDESIT PRODUCT

In order to receive a more complete assistance, please register your product on www.register10.eu

PLEASE SCAN THE QR CODE ON YOUR APPLIANCE IN ORDER TO REACH MORE INFORMATION



Before using the appliance carefully read the Safety Instruction.

PRODUCT DESCRIPTION

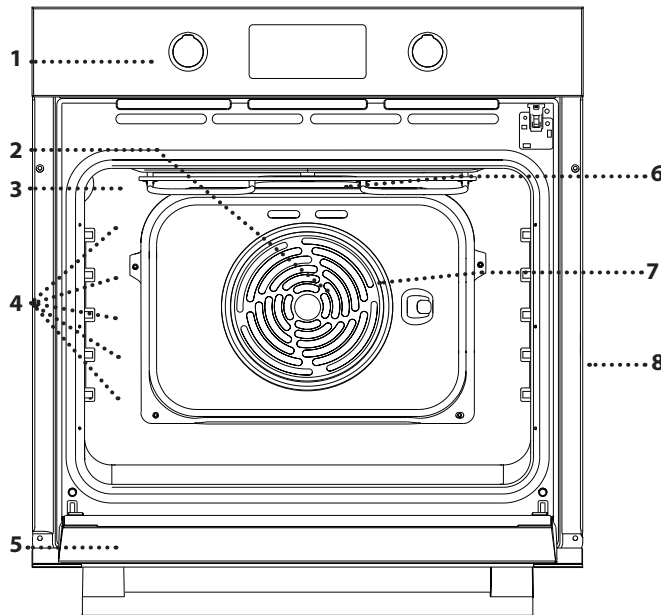

1. Control panel
2. Fan (not visible)
3. Lamp
4. Shelf guides (the level is indicated on the wall of the cooking compartment)
5. Door
6. Upper heating element/grill
7. Circular heating element (not-visible)
8. Identification plate (do not remove)

CONTROL PANEL DESCRIPTION

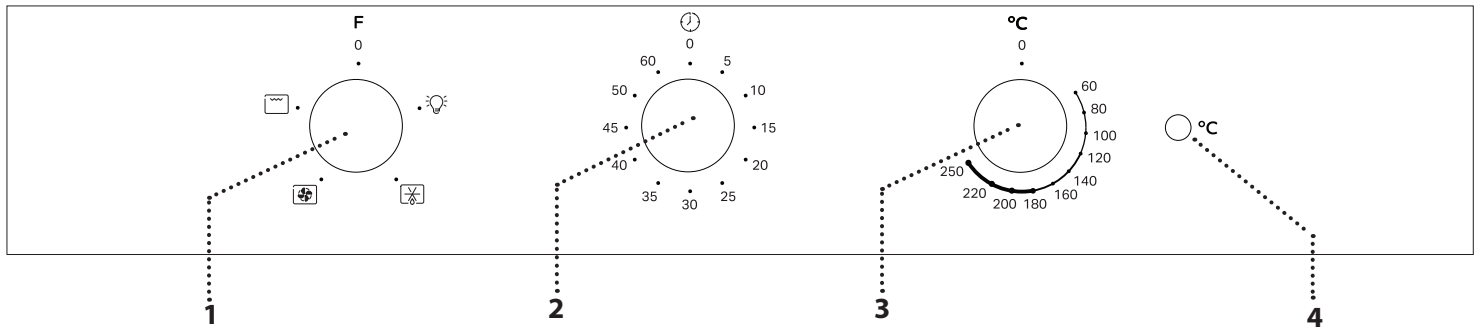

1. SELECTION KNOB

For switching the oven on by selecting a function. Turn to the 0 position to switch the oven off.

2. TIMER KNOB

Useful as a timer.

3. THERMOSTAT KNOB

Turn to select a desired temperature, activating the selected function.

4. LED THERMOSTAT/ PREHEATING

Switches on during the heating process. Switches off once the desired temperature reached.

Please note: Type of knob may vary from model type. If the knobs are push-activated, push down on the center of the knob to release it from seating.

Please note: Type of knob may vary from model type. If the knobs are push-activated, push down on the center of the knob to release it from seating.

ACCESSORIES

WIRE SHELF

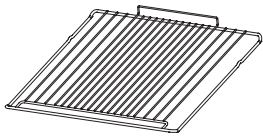

Use to cook food or as a support for pans, cake tins and other ovenproof items of cookware.

DRIP TRAY *

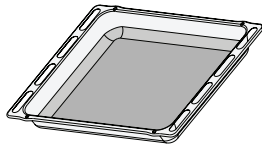

Use as an oven tray for cooking meat, fish, vegetables, focaccia, etc. or position underneath the wire shelf to collect cooking juices.

BAKING TRAY *

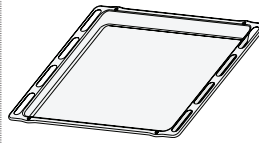

Use for cooking all bread and pastry products, but also for roasts, fish en papillote, etc.

SLIDING RUNNERS *

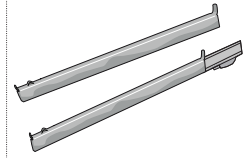

To facilitate inserting or removing accessories.

* Available only on certain models

The number and the type of accessories may vary depending on which model is purchased. Other accessories can be purchased separately from the After-sales Service.

INSERTING THE WIRE SHELF AND OTHER ACCESSORIES

Insert the wire shelf onto the level you require by holding it tilted slightly upwards and resting the raised rear side (pointing upwards) down first.

Then slide it horizontally along the runners as far as possible.

Other accessories, like the baking tray, are to be inserted horizontally, letting them slide on the runners.

SLIDING SHELVES AND SHELF GUIDES

Before using the oven remove the protective tape [a] and then remove the protective foil [b] from the sliding runners.

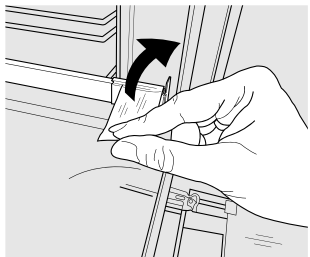

[a]

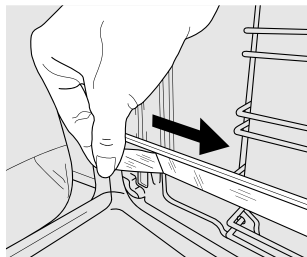

[b]

REMOVING THE SLIDING RUNNERS [c]

Pull the lower part of the sliding runner to uncouple the lower hooks (1) and pull the the sliding runners upwards, removing them from the upper hooks (2).

REFITTING THE SLIDING RUNNERS [d]

Hook the upper hooks on the shelf guides (1) then press the lower part of the sliding runners against the shelf guides, until the lower hooks are clicking (2).

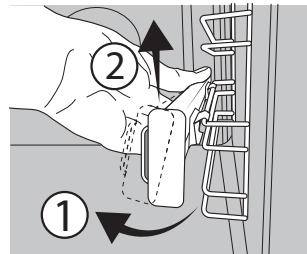

[c]

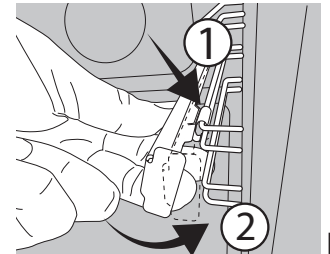

[d]

REMOVING AND REFITTING THE SHELF GUIDES

1. To remove the shelf guides, firmly grip the external part of the guide, and pull it towards you to extract the support and the two internal pins from the lodging.

2. To reposition the shelf guides, position them near the cavity and initially insert the two pins into their lodgings. Next, position the external part near its lodging, insert the support, and firmly press towards the wall of the cavity to make sure the shelf guide is properly secured.

FIRST TIME USE

A new oven may release odours that have been left behind during manufacturing: this is completely normal.

Before starting to cook food, we therefore recommend heating the oven with it empty in order to remove any possible odours.

Remove any protective cardboard or transparent film from the oven and remove any accessories from inside it.



Heat the oven to 250 °C for about one hour. The oven must be empty during this time.

Please note: It is advisable to air the room after using the appliance for the first time.

FUNCTIONS

 **OFF**
For switching off the oven.

 **LIGHT**
For switching on the light in the compartment.

 **DEFROST**
For defrosting food more quickly. To activate the defrosting function turn the selection knob to the icon  then turn the thermostat knob clockwise to any temperature. This function does not heat so any temperature can be used. When defrosting is completed turn the two controls to the 0 position.

 **FORCED AIR**
For cooking different foods that require the same cooking temperature on several shelves (maximum three) at the same time. This function can be used to cook different foods without odours being transferred from one food to another.

 **GRILL**
For grilling steaks, kebabs and sausages, cooking vegetables au gratin or toasting bread. When grilling meat, we recommend using a Baking tray to collect the cooking juices: position the pan on any of the levels below the wire shelf and add 200 ml of drinking water.

DAILY USE

SELECT A FUNCTION

To select a function, turn the *selection knob* to the symbol for the function you require

ACTIVATE A FUNCTION

To start the function you have selected, turn the thermostat knob to set the temperature you require. To interrupt the function at any time, switch off the oven, turn the selection knob and the thermostat knob to 0.

PREHEATING

Once the function has been activated, the LED thermostat will switch on signalling that the preheating process has begun. At the end of this process, the LED thermostat switches off indicating that the oven has reached the set temperature: at this point, place the food inside and proceed with cooking.

SETTING THE TIMER

This option does not interrupt or activate cooking but allows you to use the minute minder both while a function is active and when the oven is off.































































To activate the timer, turn the timer knob to the desired length of time:

An acoustic signal will warn you when the countdown is finished.

NOTES

- Do not cover the inside of the oven with aluminium foil.
- Never drag pots or pans across the bottom of the oven as this could damage the enamel coating.
- Do not place heavy weights on the door and do not hold on to the door.







































COOKING TABLE

RECIPE	FUNCTION	PREHEAT	TEMPERATURE (°C)	DURATION (MIN)	LEVEL AND ACCESSORIES
Leavened cakes		Yes	150 - 170	30 - 90	
		Yes	160 - 180	30 - 90	 
Biscuits/tartlets		Yes	150 - 170	15 - 35	
		Yes	150 - 170	20 - 45	 
		Yes	150 - 170	20 - 45	  
Choux buns		Yes	180 - 200	30 - 50	
		Yes	170 - 190	35 - 50	 
Meringues		Yes	90	150 - 200	
		Yes	90	140 - 200	 
		Yes	90	140 - 200	  
Pizza / Focaccia		Yes	220 - 250	10 - 25	
		Yes	200 - 240	20 - 45	 
Bread loaf 80 g		Yes	180 - 200	30 - 45	
Sliced bread 500 g		Yes	180	50 - 70	
Bread		Yes	180 - 200	30 - 80	 
Frozen pizza		Yes	250	10 - 20	
		Yes	230 - 250	10 - 25	 
Salty cakes (vegetable pie, quiche)		Yes	180 - 200	30 - 45	
		Yes	180 - 200	35 - 50	 
		Yes	180 - 200	35 - 50	  
Vols-au-vents / puff pastry crackers		Yes	190 - 200	20 - 30	
		Yes	180 - 190	20 - 40	 
		Yes	180 - 190	20 - 40	  

FUNCTIONS	 Grill	 Forced Air
-----------	---	--

ACCESSORIES	 Wire shelf	 Baking dish on the wire shelf	 Baking tray/Drip tray or baking dish on the wire shelf	 Drip tray / Baking tray	 Drip tray / Baking tray with 200 ml of water
-------------	--	---	--	---	--

COOKING TABLE

RECIPE	FUNCTION	PREHEAT	TEMPERATURE (°C)	DURATION (MIN)	LEVEL AND ACCESSORIES
Lasagne / baked pasta / cannelloni / flans		Yes	180 - 200	45 - 65	3 
Lamb / veal / beef /pork 1 kg		Yes	190 - 200	80 - 110	3 
Roast pork with crackling 2 kg		Yes	180 - 190	110 -150	3 
Chicken/rabbit/duck 1 kg		Yes	200 - 230	50 - 100	3 
Turkey / goose 3 kg		Yes	180 - 200	150 - 200	2 
Baked fish/en papillote (fillets, whole)		Yes	170 - 190	30 - 45	3 
Stuffed vegetables (tomatoes, courgettes, aubergines)		Yes	180 - 200	50 - 70	3 
Baked potatoes		Yes	200 - 220	30 - 50	3 
Toasted bread		5'	250	1 - 3	5 
Fish fillets/slices		5'	250	15 - 30*	4  3 
Sausages/kebabs/spare ribs/hamburgers		5'	250	15 - 30*	5  4 
Vegetable gratin		5'	250	5 - 15	4 
Meat and potatoes		Yes	190 - 200	45 - 100***	4  1 
Fish and vegetables		Yes	180	30 - 50***	4  2 
Lasagne and meat		Yes	200	50 - 100***	4  1 
Complete meal: fruit tart (level 5) / lasagne (level 3) / meat (level 1)		Yes	180 - 190	40 - 120***	5  3  1 

* Turn food halfway through cooking

** Turn food two thirds of the way through cooking (if necessary).

*** Estimated length of time: dishes can be removed from the oven at different times depending on personal preference.

The time indicated does not include the preheating phase: we recommend placing the food in the oven and setting the cooking time only after the required temperature has been reached.

FUNCTIONS		
	Grill	Forced Air

ACCESSORIES					
	Wire shelf	Baking dish on the wire shelf	Baking tray/Drip tray or baking dish on the wire shelf	Drip tray / Baking tray	Drip tray / Baking tray with 200 ml of water

CLEANING AND MAINTENANCE

Make sure that the oven has cooled down before carrying out any maintenance or cleaning. Do not use steam cleaners.

Do not use wire wool, abrasive scourers or abrasive/corrosive cleaning agents, as these could damage the surfaces of the appliance.

Wear protective gloves. The oven must be disconnected from the mains before carrying out any kind of maintenance work.

EXTERIOR SURFACES

Clean the surfaces with a damp microfibre cloth. If they are very dirty, add a few drops of pH-neutral detergent. Finish off with a dry cloth.

Do not use corrosive or abrasive detergents. If any of these products inadvertently comes into contact with the surfaces of the appliance, clean immediately with a damp microfibre cloth.

INTERIOR SURFACES

- After every use, leave the oven to cool and then clean it, preferably while it is still warm, to remove any deposits or stains caused by food residues. To dry any condensation that has formed as a result of cooking foods with a high water content, leave the oven to cool completely and then wipe it with a cloth or sponge.

- If there is stubborn dirt on the interior surfaces, we recommend running the automatic cleaning function for optimal cleaning results. Avoid activating the pyrolytic cycle cleaning in the presence of limescale residues. Before activating, perform limescale cleaning as described above.
- The door can be easily removed and refitted to facilitate cleaning of the glass.
- Clean the glass in the door with a suitable liquid detergent.

ACCESSORIES

Soak the accessories in a washing-up liquid solution after use, handling them with oven gloves if they are still hot. Food residues can be removed using a washing-up brush or a sponge.

REMOVING AND REFITTING THE DOOR

1. To remove the door, open it fully and lower the catches until they are in the unlock position.

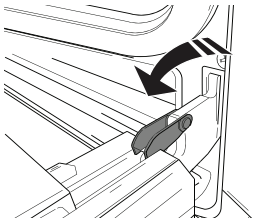

2. Close the door as much as you can. Take a firm hold of the door with both hands – do not hold it by the handle. Simply remove the door by continuing to close it while pulling it upwards (a) at the same time until it is released from its seating (b). Put the door to one side, resting it on a soft surface.

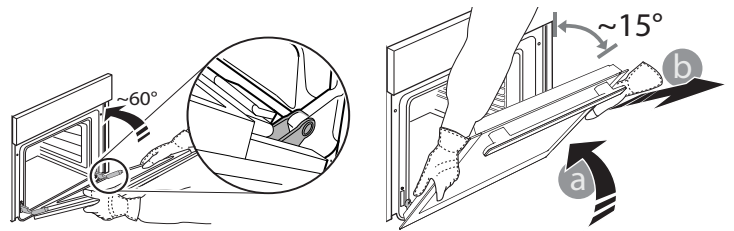

3. Refit the door by moving it towards the oven, aligning the hooks of the hinges with their seating and securing the upper part onto its seating.

4. Lower the door and then open it fully.

Lower the catches into their original position: Make sure that you lower them down completely.

5. Try closing the door and check to make sure that it lines up with the control panel. If it does not, repeat the steps above.

LOWER THE UPPER HEATING ELEMENT

1. Extract the heating element from its seating, then lower it.

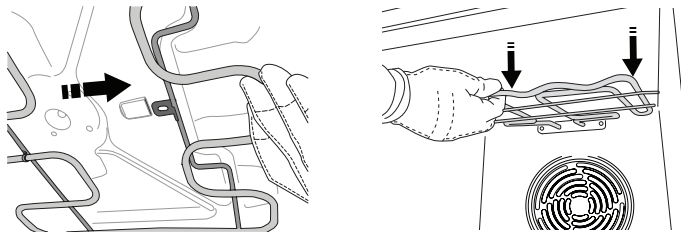

2. To return the heating element to its position, lift it up, pull it slightly towards you and make sure that the tab support is in its proper seating.

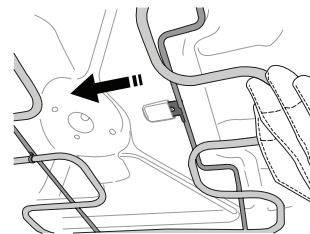

CLICK & CLEAN - CLEANING THE GLASS

1. After removing the door and resting it on a soft surface with the handle downwards, simultaneously press the two retaining clips and remove the upper edge of the door by pulling it towards you.

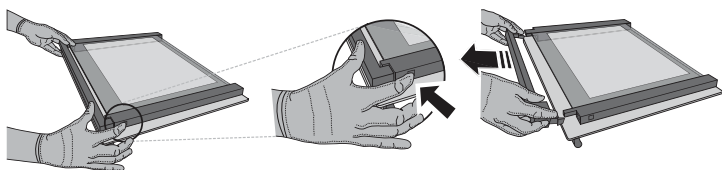

2. Lift and firmly hold the inner glass with both hands, remove it and place it on a soft surface before cleaning it.

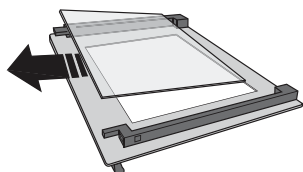

3. Refit the intermediate pane (marked with "1R") before refitting the inside pane: To position the panes of glass correctly, make sure that the "R" mark can be seen in the left-hand corner. First insert the long side of the glass marked "R" into the support seats, then lower it into position. Repeat this procedure for both panes of glass.

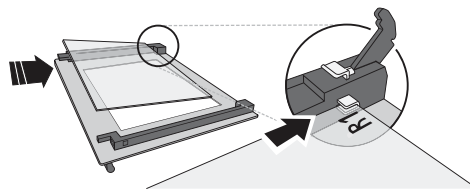

4. Refit the upper edge: A click will indicate correct positioning. Make sure the seal is secure before refitting the door.

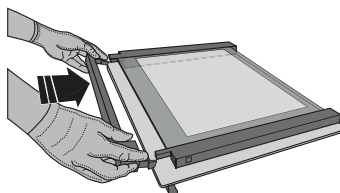

REPLACING THE LAMP

Disconnect the oven from the power supply, unscrew the cover from the light, replace the bulb and screw the cover back on the light.

Reconnect the oven to the power supply. Do not use the oven until the light cover has been refitted.

Please note: Use 25 W/230 V type G9, T300 °C halogen lamps.

The bulb used in the product is specifically designed for domestic appliances and is not suitable for general room lighting within the home (EC Regulation 244/2009).

Light bulbs are available from our After-sales Service. - Do not handle bulbs with your bare hands as your fingerprints could damage them. Do not use the oven until the light cover has been refitted.

TROUBLESHOOTING

PROBLEM	POSSIBLE CAUSE	SOLUTION
The oven does not work.	Power cut. Disconnection from the mains.	Check for the presence of mains electrical power and whether the oven is connected to the electricity supply. Turn off the oven and restart it to see if the fault persists.

Policies, standard documentation and additional product information can be found by:

- Using the QR code in your appliance
- Visiting our website docs.indesit.eu
- Alternatively, **contact our After-sales Service** (See phone number in the warranty booklet). When contacting our After-sales Service, please state the codes provided on your product's identification plate.

