

# DAILY REFERENCE GUIDE



**THANK YOU FOR BUYING A WHIRLPOOL PRODUCT.**  
For even more complete user support, register your appliance at [www.whirlpool.eu/register](http://www.whirlpool.eu/register)



Download the **Instructions for use** from the website <http://docs.whirlpool.eu>  
Follow the procedure described on the last page.

**Please read the content of the *Health & Safety and Installation Guides* thoroughly before you use this appliance.**



The transit bolts must be removed before the appliance is used.

See the *Health & Safety and Installation Guides* for detailed instructions on how to remove the transit bolts

## PRODUCT DESCRIPTION

### APPLIANCE

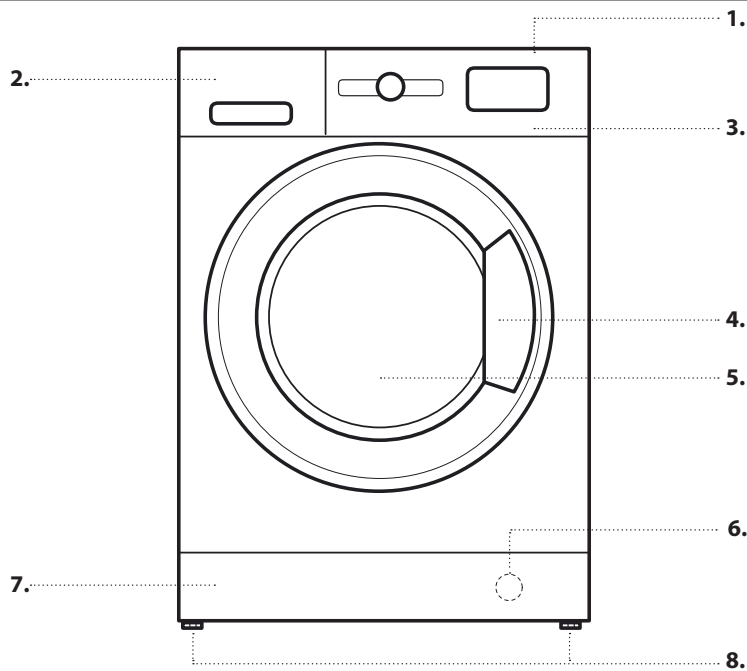

- 1. Top
- 2. Detergent dispenser
- 3. Control Panel
- 4. Lid handle
- 5. Door
- 6. Water filter - behind kick panel
- 7. Removable kick panel
- 8. Adjustable feet (2)

### CONTROL PANEL

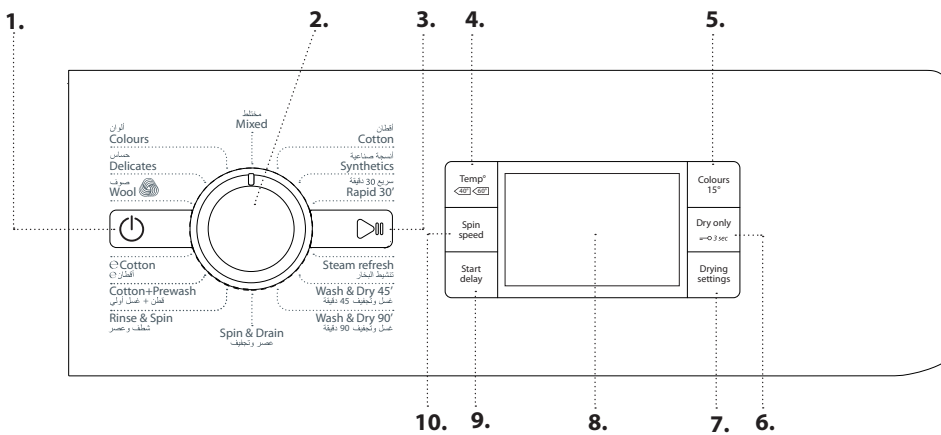

- 1. On/Off button
- 2. Programme selector
- 3. Start/Pause button
- 4. Temperature button
- 5. Colours 15°C button
- 6. Dry Only button / Lock button
- 7. Drying settings button
- 8. Display
- 9. Start delay button
- 10. Spin speed button



SENSING THE DIFFERENCE

## DETERGENT DISPENSER

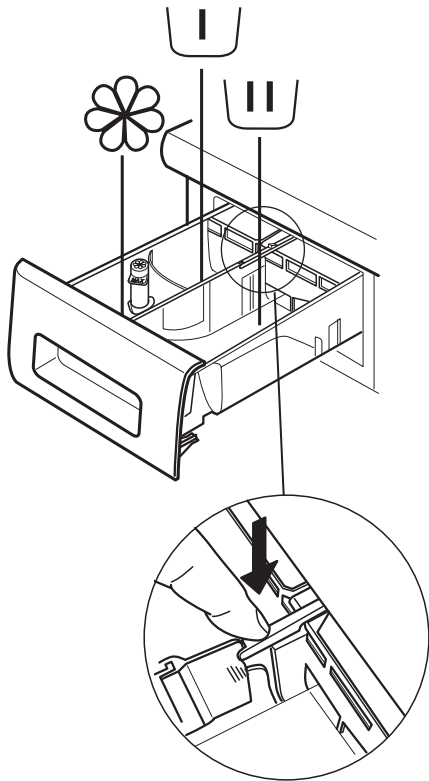

### Prewash Compartment

- Detergent for prewash



### Main Wash Compartment

- Detergent for the main wash
- Stain remover
- Water softener



### Softener compartment

- Softener
- Liquid starch

**Pour softener or starch solution into the compartment without exceeding the "max" level.**

### Release button

(press to remove tray for cleaning).

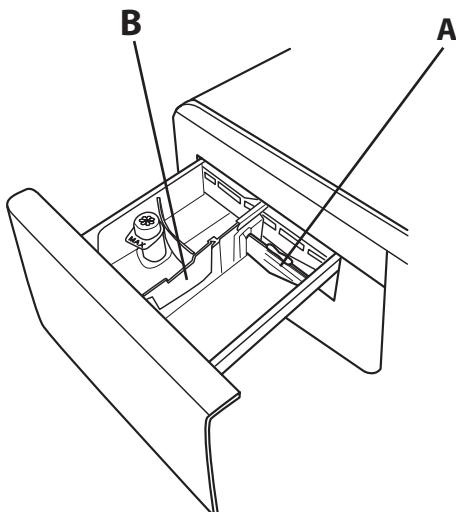

Preferably use the partition **A** when washing with a liquid detergent for washing, to ensure that the correct quantity of detergent is used (the partition is included in the bag containing the instructions). Move the partition into slot **B** when using detergent powder.

## FIRST TIME USE

See the section *DAILY USE* for instructions on selecting and starting a programme.

### FIRST CYCLE OPERATION

Remove any manufacturing debris:

1. Select the "Cotton" programme with a temperature setting of 90 °C.
2. Pour a small quantity of detergent powder into the main wash compartment of the detergent dispenser (maximum 1/3 of the quantity the detergent manufacturer recommends for lightly soiled laundry).
3. Start the programme **without loading the washer dryer machine** (with empty drum).



# DAILY USE

For more information on functions, a more detailed guide may be requested or downloaded from the website following the instructions given on the last page. 

## 1. LOADING LAUNDRY.



- Prepare the laundry, following the recommendations given in the section "HINTS AND TIPS". - Open the door and load the laundry into the drum, without exceeding the maximum load capacities indicated in the *Programme Chart*.
- Close the door, pressing until the latch audibly locks, and check that there is no laundry trapped between the door glass and the rubber seal.



## 2. OPEN THE WATER TAP

Check that the washer dryer is connected correctly to the water mains. Open the water tap. 

## 3. SWITCHING ON THE WASHER DRYER MACHINE.

Press button ; the lamp  flashes slowly.

## 4. SELECTING A PROGRAMME AND CUSTOMISING A CYCLE.

The following functions are possible with this appliance:

- Wash only
- Wash and dry
- Dry only

### Wash only

Select the required programme with the PROGRAMME selector dial. The duration of the wash cycle is shown on the display. The washer dryer machine automatically displays the maximum temperature and spin speed settings possible for the selected programme. Adjust the temperature and/or spin speed settings if needed with the relative buttons.

- Press button "Temp" to cycle through progressively lower temperature settings until cold wash is set ("-" shown on display).
- Press button "Spin speed" to cycle through progressively lower spin speed settings until the spin cycle is turned off ("0" shown on display).

Pressing the button again sets the highest possible setting. Select the required options (if necessary).

- Press the button to select the option; the respective button lamp illuminates.
- Press the button again to cancel the option; the lamp extinguishes.

! If the selected option is not compatible with the programme set, an error warning tone sounds and the indicator lamp flashes three times. The option is not selected.

### Wash and dry

To wash and dry a load with no interruption between the wash and dry cycles, make sure that the load does not exceed the maximum permissible drying load for the selected programme (see the column "Max. load for drying cycle" in the *Programme chart*).

1. Follow the instructions given in the paragraph "Wash Only" to select and, if necessary, customise the required programme.

2. Press "Drying settings" to select the required drying mode. Two drying modes are available: automatic or timer.

- *Automatic drying with selectable levels:*

In automatic drying mode, the washer dryer machine dries the laundry until the set level of dryness is reached. Pressing button "Drying settings" once automatically selects the highest drying level available for the selected programme. Press the button again to reduce the drying level.

The following levels are available:

Wardrobe : laundry is completely dry and ready to be put away in the wardrobe without ironing.

Hanger : laundry is left slightly damp to minimise creasing. Garments must be hung to air dry completely.

Iron : garments are left reasonably damp to make ironing easier.

- *Timer drying mode:*

Press button "Drying settings" repeatedly to set timer drying mode. After cycling through all the automatic drying levels, continue pressing button "Drying settings" until the desired time is displayed. Values from 210 to 30 minutes are settable.

To wash a load of laundry larger than the maximum permissible load for drying (see the column "Max. load for drying cycle" in the *Programme chart*), remove a few garments once the washing cycle has finished before starting the drying cycle. Proceed as follows:

1. Follow the instructions given in the paragraph "Wash Only" to select and, if necessary, customise the required programme.
2. Do not include a drying cycle.
3. Once the washing cycle is finished, open the door and remove a few garments to reduce the load. Now follow the instructions for "Dry only".

N.B.: always allow a cooling down period after drying before opening the door.

When using the two preset cycles "Wash & Dry 45'" and "Wash & Dry 90'", it is not necessary to select and start a drying cycle.

### Dry only

This function is used to simply dry a wet load washed previously in the washer dryer or by hand.

1. Select a suitable programme for the laundry you want to dry (e.g. select cotton to dry wet cotton laundry).
2. Press button "Dry only" to dry without a wash cycle.
3. Press "Drying settings" to select the required drying mode. Two drying modes are available: automatic or timer.

- *Automatic drying with selectable levels:*

In automatic drying mode, the washer dryer machine dries the laundry until the set level of dryness is reached. Pressing button "Drying settings" once automatically selects the highest drying level available for the selected programme. Press the button again to reduce the drying level.

The following levels are available:

Wardrobe : laundry is completely dry and ready to be put away in the wardrobe without ironing.

Hanger : laundry is left slightly damp to minimise creasing. Garments must be hung to air dry completely.

Iron : garments are left reasonably damp to make ironing easier.

- *Timer drying mode:*

Press button "Drying settings" repeatedly to set timer drying mode. After cycling through all the automatic drying levels, continue pressing button "Drying settings" until the desired time is displayed.



Values from 210 to 30 minutes are settable.

N.B.: always allow a cooling down period after drying before opening the door.

**5. USING THE CORRECT AMOUNT OF DETERGENT.** Pull out the tray and pour detergent into the relative compartments as described in "*Detergent dispenser*". This is only necessary when using a wash only or a wash + dry programme.

**6. DELAYING THE START OF A PROGRAMME.** To set a programme to start at a later time, see the section "*Options and Functions*".

## **7. STARTING A PROGRAMME.**

Press the START/PAUSE button. The relative indicator lamp illuminates, the door locks and the door open  symbol extinguishes. To change a programme while a cycle is in progress, press START/PAUSE to pause the washer dryer (the START/ PAUSE lamp flashes amber slowly); then select the required cycle and press START/PAUSE again. To open the door while a cycle is in progress, press START/PAUSE; the door may be opened if the  symbol lights. Press the START/ PAUSE button again to resume the programme from where it was paused.



## **8. CANCELLING A RUNNING PROGRAMME (IF NECESSARY)**

Press and hold the button  until the washer dryer stops. If the water level and temperature are low enough, the door unlocks and may be opened.

The door remains locked if there is water in the drum. To unlock the door, switch the washer dryer on, select the SPIN & DRAIN programme and turn the spin function off by setting the spin speed to 0. The water is emptied and the door unlocks at the end of the programme.

## **9. SWITCHING THE WASHER DRYER OFF AT THE END OF A PROGRAMME.**

At the end of the cycle, the message "END" is shown on the display. The door can only be opened when the  symbol lights. Check that the door unlocked symbol is lit, then open the door and take out the laundry.

Press  to switch the washer dryer off. To save energy, if the washer dryer is not switched off manually with the  button, it turns off automatically approximately 30 minutes after the end of the programme.

Leave the door ajar to let the interior of the washer dryer dry.

# HINTS AND TIPS

## RULES FOR SEPARATING LAUNDRY

- Fabric type / indications on label (cotton, mixed fibres, synthetic, wool, handwash items)
- Colour (separate coloured garments from whites, wash new coloured items separately)
- Size (wash items of different sizes in the same load to improve washing efficacy and weight distribution in the drum)
- Delicates (place small items – such as nylon stockings – and garments with clasps – such as braziers – in a laundry bag or in a pillow case with a zip).





## EMPTY POCKETS

- Objects such as coins or safety pins can damage laundry and the washer dryer drum.

## WASH SYMBOLS

### ON GARMENT LABELS

The value given in the tub symbol is the maximum temperature possible for washing the garment.

-  Normal mechanical action
-  Reduced mechanical action
-  Much reduced mechanical action
-  Hand wash only
-  Do not wash

## CLEAN THE WATER FILTER REGULARLY

- This is needed to prevent the filter from blocking and preventing the water from draining correctly. See the section “*Cleaning and Maintenance*” / “*Cleaning the water filter*” in the detailed guide that may be requested or downloaded from the website.  [www](#)

## SAVING ENERGY AND PROTECTING THE ENVIRONMENT

- Keeping within the load limits indicated in the programme chart will optimise energy, water and detergent consumption and reduce washing times.
- Do not exceed the detergent quantities recommended by the detergent manufacturer.
- Save energy by using a 60°C instead of a 90°C wash programme, or by using a 40°C instead of a 60°C wash programme. We recommend using the “ Cotton” 60°C programme for cotton garments, which is longer but uses less energy.
- To save energy and time when washing and drying, select highest spin speed available for the programme to reduce the residual water remaining in the garments at the end of the wash cycle.

# PROGRAMME CHART

Programme	Available temperatures	Max. spin speed (rpm)	Drying	Max. load for wash cycle (kg)	Max. load for drying cycle (kg)	Duration (Minutes)	Detergents and additives			Recommended detergent	
							Prewash	Main	Softener	Powder	Liquid
COTTON	☼ - 90°C	1400	✓	9	6	The duration of the programme is shown on the display.	-	●	○	✓	✓
SYNTHETICS	☼ - 60°C	1000	✓	4,5	4		-	●	○	✓	✓
RAPID 30'	☼ - 30°C	800	-	3,5	-		-	●	○		✓
STEAM REFRESH	-	-	-	2	-		-	-	-		
WASH & DRY 45'	30°C	1400	✓	1	1		-	●	○		✓
WASH & DRY 90'	30°C	1200	✓	2	2		-	●	○		✓
SPIN & DRAIN	-	1400	✓	9	6		-	-	-		
DRAIN ONLY *	-	0	-	9	-		-	-	-		
RINSE & SPIN	-	1400	✓	9	6		-	-	○		
COTTON+PREWASH	☼ - 90°C	1400	✓	9	6		●	●	○	✓	
☺ COTTON (1)	☼ - 60°C	1400	✓	9	6		-	●	○	✓	✓
☺ COTTON (2)	☼ - 40°C	1400	✓	9	6		-	●	○	✓	✓
WOOL	☼ - 40°C	800	✓	2	2		-	●	○		✓
DELICATES	☼ - 30°C	0	✓	1	1		-	●	○		✓
COLOURS	☼ - 40°C	1400	✓	9	6	-	●	○		✓	
MIXED	☼ - 40°C	1000	✓	4,5	4,5	-	●	○		✓	

Selectable/optional      - Not selectable/applicable      ● Required quantity      ○ Optional quantity

For wash programmes with temperatures above 50°C, we recommend using powder detergent rather than liquid, and following the directions given on the detergent package.

\* Select the SPIN & DRAIN programme and set the spin speed to 0 to empty only.

- 1) Test programme in compliance with standard EN 50229 (Wash): select the "☺ Cotton" programme with a temperature of 60°C.
- 2) Long cotton programme: set the "☺ Cotton" programme with a temperature of 40°C.

Test programme in compliance with standard EN 50229 (Drying): the greater load (6kg) must be dried by selecting the dryness level. The remainder of the load must be dried by selecting the dryness level: the load must consist of 3 sheets, 2 pillowcases and 1 hand towel.

The cycle duration indicated on the display or in the manual is an estimated time calculated for standard conditions. The actual cycle time may vary in relation to a number of different factors, such as inlet water temperature and pressure, ambient temperature, quantity of detergent, size and type of load, load balancing and any additional optional functions selected.

# PROGRAMMES

Follow the directions indicated in the garment wash symbols.

## COTTON

for washing normally to heavily soiled towels, underwear, table and bed linen etc. in resilient cotton and linen.

## SYNTHETICS

for washing normally soiled garments made from synthetic fibres (such as polyester, polyacrylic, viscose etc.) or cotton/synthetic blends.

## RAPID 30'

for washing lightly soiled garments quickly: this cycle lasts only 30 minutes, saving time and energy. Maximum load 3,5 Kg.

## STEAM REFRESH

for refreshing garments, neutralised unpleasant odours and relaxing the fibres by delivering steam into the drum. The garments will be damp at the end of the cycle.

## WASH & DRY 45'

for washing and drying lightly soiled cotton and synthetic fibre garments quickly. This cycle washes and dries a laundry load of up to 1 Kg in just 45 minutes.

## WASH & DRY 90'

for washing and drying cotton and synthetic fibre garments quickly. This cycle washes and dries a laundry load of up to 2 Kg in just 90 minutes.

## SPIN & DRAIN

spins the load then empties the water. For resilient garments.

## RINSE & SPIN

rinses and then spins. For resilient garments.

## COTTON+PREWASH

for washing heavily soiled towels, underwear, table and bed linen etc. in resilient cotton and linen where a prewash is required. Use only powder detergent in the "Main Wash Compartment".

## COTTON

for washing normally soiled cotton garments. At 40°C and 60°C, this is the standard cotton programme and the most efficient in terms of water and energy consumption.

## WOOL - Woolmark Apparel Care - Green:

The wool wash cycle of this machine has been approved by The Woolmark Company for the washing of wool garments labelled as "hand wash" provided that the products are washed according to the instructions on the garment label and those issued by the manufacturer of this washer dryer. (M1318)



## DELICATES

for washing particularly delicate garments. Preferably turn garments inside out before washing.

## COLOURS

for washing coloured cotton garments. This programme is optimised to keep colours bright even after repeated washing.

## MIXED

for washing lightly to normally soiled resilient garments in cotton, linen, synthetic fibres and mixed fibres.

# OPTIONS AND FUNCTIONS

## OPTIONS selectable directly by pressing the relative button

! If the selected option is not compatible with the programme set, an error warning tone sounds and the indicator lamp flashes three times. The option is not selected.

## COLOURS 15°

This option helps protect colours by washing in cold water (15°C). This option uses less energy to heat the water while still offering satisfactory wash results.



Suitable for lightly soiled, unstained garments, depending on the programme selected previously.

**Note:** selecting this option together with the "MIXED" programme offers wash results comparable to a 40°C cycle at just 15°C.

## START DELAY

To set the selected programme to start at a later time, press the button to set the desired delay time. The  symbol lights on the display when this function is enabled. To cancel the delayed start, press the button again until the value "0" is shown on the display.

## LOCK BUTTON

to lock the control panel, press and hold the button "Dry only" for approximately 3 seconds. the symbol  lights on the display to indicate that the control panel is locked (with the exception of the  button). This prevents unintentional changes to programmes, especially with children near the machine.

If any attempt is made to use the control panel, the symbol  flashes on the display.

To unlock the control panel, press and hold the button "Dry only" for approximately 3 seconds.

---

#### MAINTENANCE AND TROUBLESHOOTING GUIDE

See the **Instructions for use** for instructions on maintenance procedures and troubleshooting problems.



#### TECHNICAL DOSSIER

The technical dossier containing energy consumption figures may be downloaded from the Whirlpool website <http://docs.whirlpool.eu>

#### CONTACTING THE AFTER-SALES SERVICE

When contacting the After-Sales Service, you will need to be able to provide the codes indicated on the adhesive label on the inner side of the door. The telephone number is indicated in the warranty booklet.

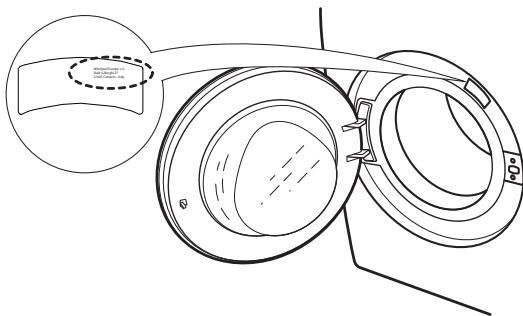

#### HOW TO RECEIVE THE INSTRUCTIONS FOR USE

- > Phone the After-Sales Service
- > Use this QR Code



- > Download the guide from the Whirlpool website

<http://docs.whirlpool.eu>

To do this, you need to enter the correct commercial code of the product indicated on the adhesive label.

---

Whirlpool® is a registered trademark of Whirlpool, USA.

