

# DAILY REFERENCE GUIDE



## THANK YOU FOR BUYING A WHIRLPOOL PRODUCT.

In order to receive a more complete assistance, please register your appliance on <http://www.whirlpool.eu/register>

Before using the appliance carefully read the *Health and Safety* guide.

## PRODUCT DESCRIPTION

### APPLIANCE

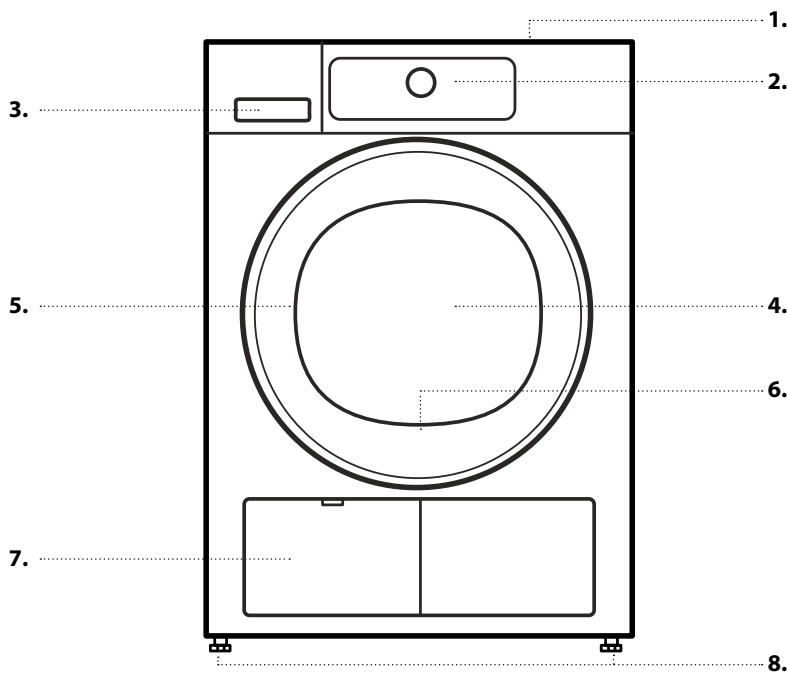

1. Worktop
2. Control panel
3. Water tank
4. Door
5. Door handle
6. Door filter (behind door)
7. Bottom filter (behind flap)
8. Adjustable feet (4)

### CONTROL PANEL

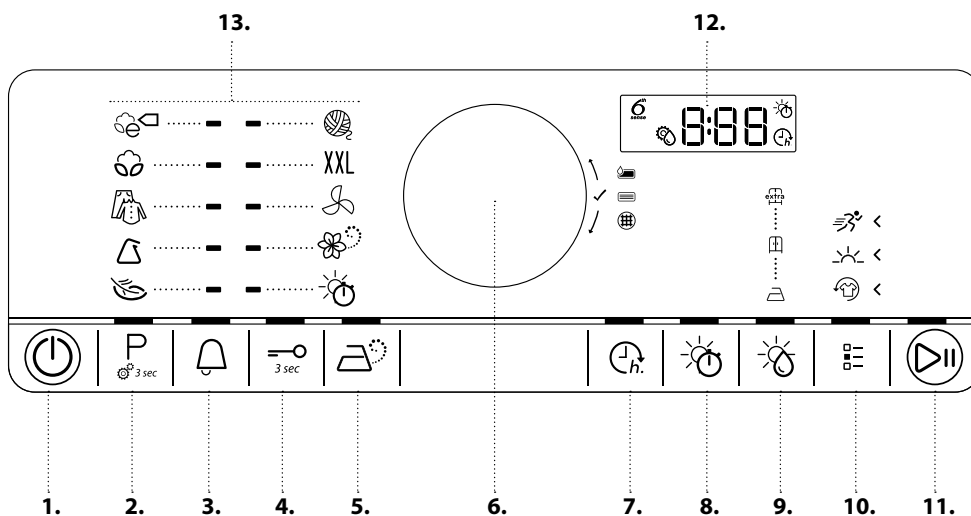

1. On/Off button (Reset if long pressed)
2. Programme button (Water conductivity setting if long pressed)
3. Cycle end alert
4. Key lock
5. Steam option
6. Knob (Turn to select / Press to confirm)
7. Start delay
8. Drying time
9. Dryness level
10. Options button
11. Start / Pause button
12. Display
13. Programmes area

# FIRST TIME USE

## BEFORE USING THE DRYER

### CHECK DRAIN HOSE AND WATER TANK

Make sure that the drain hose on the back of the dryer is fixed correctly, either to the dryer's water tank (see picture), or to your domestic sewage system (see Installation guide).

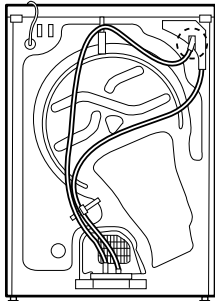

Also make sure that the water tank is correctly inserted.

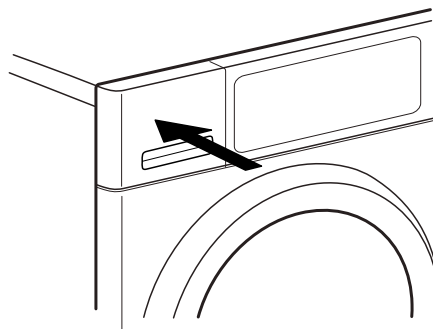

## DAILY USE

See Use and Care Guide for more details on functions / see last page for information on how to obtain the Use and Care Guide

### ⚠ WARNING

**Make sure that no lighters or matches remain in the laundry.**

**Make sure that the laundry is not soaked with flammable liquids.**

### 1. LOAD LAUNDRY

Prepare your laundry according to the recommendations in section **HINTS AND TIPS**.  
Make sure that pockets are empty, fasteners closed and ribbons tied together.



Open the door and load the laundry. Observe the maximum load sizes given in the **PROGRAMME CHART**.



### 2. CLOSE DOOR

Make sure that no laundry gets stuck between door glass and door filter.

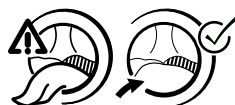

Close the door so that you can hear it click shut.



### 3. SWITCH ON DRYER

Press the *On/Off button* « until the programme button lights up. An animation occurs, and there is a sound. Afterwards the dryer is ready to be operated.

### 4. SET THE DESIRED PROGRAMME

**GUIDED MODE** – the button light will guide you through setting your programme in the following order: selection of programme / drying time (ONLY if *Drying time* or *Airing programme* is selected) / dryness level (only if selectable / adjustable) / options. As soon as you confirm a selection by pressing the knob, the button light will jump to the next step.

P

#### Select programme:

Make sure that the *Programme button* « lights up. Turn the knob to select the desired programme. The indicator next to the selected programme lights up. Confirm the desired programme by pressing the knob.

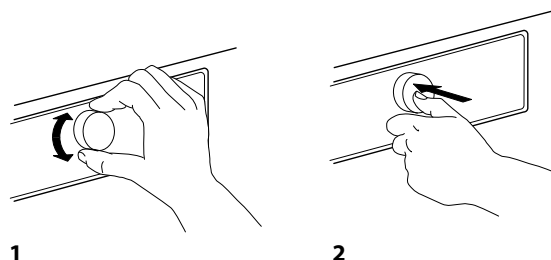

Find more information regarding programmes in the **PROGRAMME CHART**.



#### Select Drying time, if needed

Only if you have selected programme *Drying time* or *Airing* «, you can set the desired drying time from a minimum of 10 minutes to maximum 180 minutes (three hours). Make sure that the *Drying time button* lights up.

Turn the knob to select the desired drying time. Confirm it by pressing the knob.



#### Set dryness level, if needed

If you want to change the dryness level, make sure that the *Dryness level button* « lights up.

Turn the knob to select the desired dryness level, then press the knob to confirm.



#### Select options, if needed

If you want to select additional options, make sure that the *Options button* « lights up. The options which are selectable for your programme are indicated by lighting arrows.



Turn the knob to select the desired options. The symbol of the selected option will blink. To confirm it, press the knob.

Some options / functions can be selected by directly pressing the button.

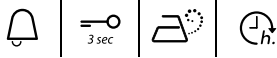

Refer to section **OPTIONS, FUNCTIONS AND INDICATORS** for more information.

#### INDIVIDUAL MODE

After you have switched on the dryer, you are not forced to follow the **GUIDED MODE**.

It is up to you which order you choose to set your programme. To do a setting, first press the relevant button, then turn the knob to select, and finally press the knob to confirm.

The variety of options and dryness levels depends on the programme selected. Therefore it is recommended to start your setting with selecting the programme.

To change the settings of a running programme or start delay, you can also:

- press *Start/Pause* to put the running programme on pause
- change your settings
- press *Start/Pause* again to continue the programme.



#### 7. RESET A RUNNING PROGRAMME, IF NEEDED

Press and hold the *On/Off button* « until "rES" appears on the display.



The programme is ended afterwards. Immediately open the door and unload the laundry, so that eventual heat in the laundry can dissipate.



#### 8. SWITCH OFF THE DRYER AFTER PROGRAMME END

At the end of the programme, „End“ appears on the display. Press *On/Off* « to switch off the dryer. Open the door and take out your laundry.



The dryer will switch off automatically in about a quarter of an hour after programme end, to save energy.

#### 9. EMPTY WATER TANK / CLEAN DOOR FILTER / CLEAN BOTTOM FILTER

Refer to section **CARE AND MAINTENANCE**.



#### 5. START PROGRAMME

Press and hold *Start/Pause* « until the button lights up solidly; the drying process starts.

The duration can be recalculated and adapted in the course of the programme.

During such phases, an animation occurs on the display.

#### 6. CHANGE THE SETTINGS OF A RUNNING PROGRAMME, IF NEEDED

You can still change some settings after a programme was started:

- Adjust drying time (only if programme *Drying time* is selected)
- Add or cancel an option, provided the progress of the programme still allows it.

Press the relevant button. The selected setting will blink for a few seconds.

While blinking, you can adjust the setting by turning the knob. If the value or setting stopped blinking, press the button again.

Press the knob to confirm the modification. If you do not confirm, the modification will be confirmed automatically — the modified setting will stop blinking.

The programme will continue automatically.

# HINTS AND TIPS

Respect the care labels of your laundry; make sure that it is appropriate for being treated in a dryer.

## CARE LABELS

The dots indicate the temperature degree for drying the laundry.

 Normal temperature

 Reduced temperature

 Do not tumble dry

## EMPTY ALL POCKETS

Objects like coins or keys can damage your laundry as well as the drum.

## ADAPTING THE DRYER TO WATER CONDUCTIVITY

The drying results are affected by the conductivity of the water used during washing. If, by modifying the available dryness levels (iron dry; cupboard dry; extra dry), you are not satisfied with the final drying results, you can adapt the water conductivity level. The dryer comes with preset level 2. Choose between level 1 (most damp results) and 5 (most dry results).

Press and hold the *Programme* button until the *Conductivity Adjustment* symbol on the display blinks.

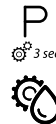

Turn the knob to adjust the level (1 – 2 – 3 – 4 – 5).

Press the knob to confirm the selected level.

This operation is not needed for every drying cycle. Once the most satisfying water conductivity level has been identified, you no longer need to modify it.

# SAVING TIPS

Always dry a full load; this optimizes the relative energy consumption. The maximum load sizes for the various programmes are indicated in the programme chart.

To reduce the drying time, make sure that the laundry is spun with the maximum possible spin speed of the wash programme. This reduces the moisture content in the laundry.

# CONSUMPTION DATA

*Data can differ in your home, mainly depending on the moisture content of the laundry load.*

Programme	Load (Kg)	Spin Speed (rpm)	Humidity (%)	Energy consumption (kWh)	Drying Time (min)
<b>ECO COTTON *</b>	9	1000	60	5.27	155
	4.5	1000	60	2.75	90
<b>ECO COTTON</b>	9	800	70	5.88	173
	9	1400	50	4.66	132
<b>COTTON IRON DRY</b>	9	800	70	5.16	147
	9	1000	60	4.62	126
	9	1400	50	4.08	111
<b>SYNTHETICS CUPBOARD DRY</b>	3.5	1000	40	1.44	46

\*Reference programmes for Energy Label / Regulation 392/2012 / EU Values are based on the default programme setting, with clean door and bottom filter. For consumer tests, the door filter and bottom filter need to be cleaned after each cycle.

The energy consumption and drying time may differ from the values above. They depend on the operation conditions in your home (such as voltage fluctuation, mixture of textiles, humidity of the textiles after spinning, load volume).

The values are determined according to European Norm 61121 and refer to the default programme setting; changing the setting also impacts the consumption data.

# PROGRAMME CHART

Programme	Care Labels	Max Load (Kg)	Directly selectable			Selectable by options button			
			Dryness level	Steam option	Drying time	Fresh Care	Gentle	Rapid	
ECO COTTON			max		—	—		—	—
COTTON			max		—	—	—	—	—
					✓	—	✓	✓	✓
					—	—	—	—	
MIXED			3,0	—	✓	—	✓	✓	—
SYNTHETICS			3,5		—	—	—	—	—
					✓	—	✓	✓	—
					—	—	—	—	
DELICATES			2,5		—	—	✓	—	—
WOOL FINISH			1,0	—	—	—	—	—	—
BIG ITEMS	XXL		3,0		—	—	✓	—	—
AIRING			max	—	—	✓	✓	—	—
				—	—	—	—	—	—
STEAM REFRESH			1,5	—	—	—	—	—	—
				—	—	—	—	—	—
DRYING TIME			max	—	—	✓	✓	—	—

✓ Selectable / Optional    — Not Selectable / Applicable

# PROGRAMMES

Make sure that your laundry is suitable to be treated in a tumble dryer. Refer to **HINTS AND TIPS** / Care labels.



## ECO COTTON

For drying normally wet cotton laundry. Standard cotton programme, suitable to dry normal wet cotton laundry. Most efficient programme in terms of energy consumption for drying cotton laundry. The values on the Energy Label are based on this programme.



## COTTON

For drying cotton laundry.



## MIXED

For drying mixed laundry made of cotton, linen, synthetic fibres and their blends.



## SYNTHETICS

For drying laundry made of synthetic fibres.



## DELICATES

For drying delicate laundry which needs gentle treatment.



## WOOL FINISH

For finishing the air-drying process of woolen textiles. Woolens get fluffy and smooth. No drying programme.



## BIG ITEMS

For drying big laundry items, such as sleeping bags, blankets etc.



## AIRING

For airing, refreshing and loosening up laundry without heating. Select the airing duration with option *Drying time*.



## STEAM REFRESH

For refreshing laundry with steam. Specifically designed to refresh and remove odors from dry and clean casual garments like shirts, blouses, trousers made out of cotton, synthetics and their blends. Before loading the laundry into the drum, slightly humidify it by spraying it with water (maximum 200 ml; use a water spray bottle). Dryness level Cupboard dry is preset and cannot be changed. After programme end, unload the laundry immediately and put on clothes hangers to minimize creasing.



## DRYING TIME

Time-restricted drying programme. Select programme duration with option *Drying time*. For all fabrics appropriate for tumble drying. Suitable to add an additional short drying phase after programme end. Refer to **OPTIONS, FUNCTIONS AND INDICATORS** / *option Drying time* for more information.

# OPTIONS, FUNCTIONS AND INDICATORS

Refer to the programme chart to check which options are available for the selected programme.

## OPTIONS WHICH ARE DIRECTLY SELECTABLE BY PRESSING THE RESPECTIVE BUTTON



### Steam option

Minimizes creasing of garments made of cotton, synthetics and their blends by adding a humidifying phase at the end of the drying cycle.

Use the option with small loads only, unload the garments from the dryer immediately after programme end and put them on clothes hangers.

The humidity level automatically adjusts to *Cupboard dry* and cannot be changed with this option.

Not combinable with options *Fresh care*, *Rapid* and *Gentle*.



### Drying time

To adjust the desired drying time, only if the *Drying time* or *Airing programme* has been selected.

Press the button; the drying time symbol on the display lights up. Turn the knob to select the desired drying time up to maximum 180 minutes, then press the knob to confirm it.

Not selectable for any other programme except the *Drying time* and *Airing programme*.





### Dryness level

To select the desired dryness level for the laundry load. Press the button, then turn the knob to select the desired dryness level; chose between



Iron dry (suitable to be ironed after the drying cycle, therefore still slightly humid)

 Cupboard dry (dry enough to be placed in a cupboard at the end of the drying cycle)

 Extra dry (maximum dryness level)

and confirm by pressing the knob.

### OPTIONS WHICH ARE SELECTABLE WITH THE OPTIONS BUTTON



#### **Fresh Care**

Helps to prevent creasing if you cannot unload the laundry soon after programme end.

The dryer starts to tumble the laundry periodically a few minutes after programme end. This tumbling will last up to approximately 12 hours after end of the programme. You can stop it at any time by switching off the dryer with the *On/Off button*.

Not combinable with *Steam option*.



#### **Gentle**

Enables a more gentle treatment of the laundry by reducing the drying temperature.

Not combinable with *Rapid* and *Steam option*.



#### **Rapid**

Enables quicker drying.

Not combinable with *Gentle* and *Steam option*.

### FUNCTIONS



#### **End of cycle signal**

To switch on and off the signal tone at the end of the programme.

= 3 sec

#### **Key lock**

To lock the keys and the knob of the control panel against unwanted operation.

To lock the keys:

- The dryer must be switched on.
- Press and hold the *Key lock button* « until the button lights up. Knob and keys are locked now. Only the *On/Off button* works.

If you switch the dryer off and on again, the key lock will remain active until you unlock it.

To unlock the keys:

- Press and hold the *Key lock button* until the button light goes off.



#### **Start delay**

Moves the start of your programme to a later time.

Choose a delay up to 23 hours.

- Select programme and options.
- Press the *Start delay button* « – the *Start delay symbol* on the display blinks.
- Turn the knob to select a delay up to 23 hours, which will be shown on the display.
- Press *Start / Pause* - the display shows the countdown of the delay until start of the programme. The *Start / Pause button* lights up. A sound by activation of the pump may occur.
- After the delay has expired, the dryer starts automatically. The display then indicates the remaining programme duration.

To cancel the *Start delay*

- Press *Start / Pause* to cancel the start delay (and press *Start / Pause* again to start the selected programme immediately).

### INDICATORS



#### **Water tank full**

(=> empty water tank)



#### **Bottom filter clogged**

(=> clean bottom filter).



#### **Door filter clogged**

(=> clean door filter)

In case of any failures, refer to section **TROUBLESHOOTING** in the **USE AND CARE GUIDE**.

# CARE AND MAINTENANCE

## ⚠ WARNING

Switch off and unplug the dryer before doing any cleaning and maintenance.

Caution, the water in the water tank can still be hot.

### EMPTY WATER TANK AFTER EACH DRYING CYCLE

Hold the handle and carefully pull out the water tank. Hold the full water tank with both hands. Empty the water and insert the container by pushing it back into place. Make sure that it is properly inserted.

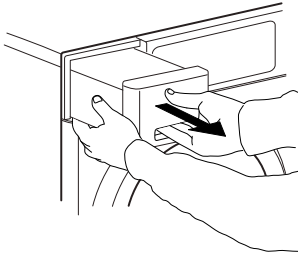

### CLEAN DOOR FILTER AFTER EACH DRYING CYCLE

Open the door and remove the door filter by pulling it upwards.

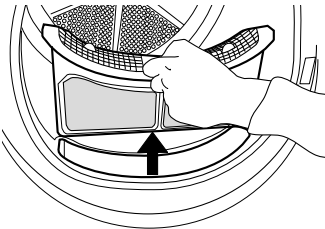

Press the button to open the door filter. Remove the lint inside. Close the filter and reinsert it in the right direction, so that it completely integrates in the filter chamber.

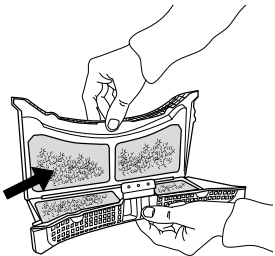

### CLEAN THE BOTTOM FILTER ABOUT EVERY THREE MONTHS

Open the bottom flap. Turn the locking bars right and left on the bottom filter downwards in horizontal position. Hold the bottom filter on the handle and pull it out.

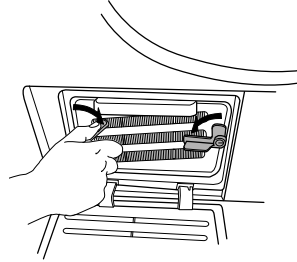

Clean the bottom filter under running water; wipe away dust and lint.

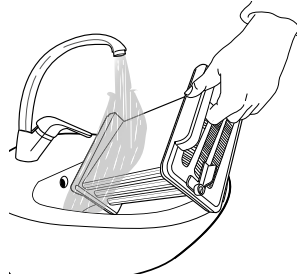

Clean the filter chamber of the dryer with a damp cloth or carefully with a vacuum cleaner. Insert the bottom filter again. Turn the locking bars upwards in vertical position. Close the bottom flap.

## MAINTENANCE AND CLEANING AND TROUBLESHOOTING

Refer to the *Use and Care Guide*.

The *Use and Care Guide* can be obtained as follows:

- After-Sales Service; using the phone number in the warranty booklet
- Download from the Whirlpool website <http://docs.whirlpool.eu>



## CONTACTING AFTER-SALES SERVICE

Provide both numbers shown on the service sticker inside the door when contacting the After-Sales Service team.

<http://www.whirlpool.eu>

The phone number can be found in the warranty booklet.



400010765174

Whirlpool is a registered trademark of Whirlpool, USA

