



**THANK YOU FOR BUYING AN INDESIT PRODUCT.**

In order to receive a more complete assistance, please register your product on [www.indesit.eu/register](http://www.indesit.eu/register)



**Before using the appliance carefully read the Safety Instructions.**

## CONTROL PANEL

- 1 ON/OFF button (hold for Reset)
- 2 Programme selection knob
- 3 Start/Pause
- 4 Push & Go

### Options buttons\*

- 5 Dryness level
- 6 Start delay
- 7 Timed drying
- 8 Cycle end
- 9 Light drying (hold for Key Lock)
- 10 Crease care (hold for Mute)

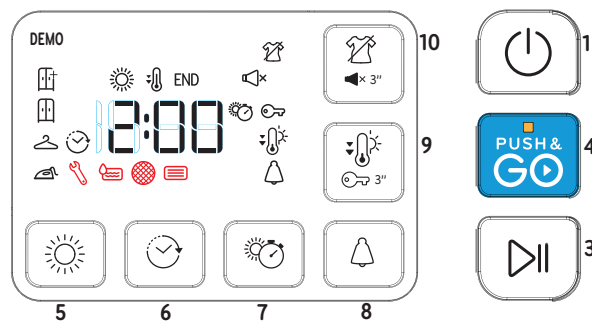
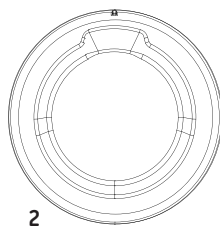

\*Note: some models may have the wording in full instead of the icons.

## INDICATORS

**Dryness level:** Iron dry - Hanger dry - Cupboard dry - Extra dry -

**Cycle phase:** Dry - Cool tumble - **END** End of cycle -

**Empty water tank** - **Clean door filter** - **Clean bottom filter**

Refer to Troubleshooting section: **Failure** call After-sales Service - **DEMO** Demo mode

## FIRST TIME USE

Make sure that the water tank is correctly inserted. Make sure that the drain hose on the back of the dryer is properly fixed, either to the dryer's water tank or to the domestic sewage system.

The dryer must be installed in a room with a temperature ranging between 5°C and 35°C to ensure proper operation. Before you use your dryer ensure that it has been in a upright position for at least 6 hours.

## DAILY USE

**Doing this will keep your machine working at its BEST:**

- remember to empty your water tank after each drying cycle.
- remember to clean your filters after each drying cycle.

**Refer to the Care & Maintenance section.**

1. Plug the dryer into the power supply socket.
2. Open the door and load garments; always refer to instructions on clothing labels and the max loads indicated in the programme section. Empty pockets. Make sure garments do not get caught between the door and/or the door filter. Do not load items that are dripping wet. Do not tumble dry large, very bulky items.
3. Close the door.
4. Press the "On/Off" button.
5. Select the most suitable programme for the type of fabric in that load.
6. Select the options, if necessary.
7. Press the "Start/Pause" button to begin drying.
8. At the end of the drying cycle, a buzzer will beep. An indicator on the control panel signals the end of the cycle. Pull the load out immediately to prevent the formation of creases on laundry.
9. Turn the machine off by pressing the "On/Off" button, open the door and pull the clothing out. If the machine is not switched off manually, after about a quarter of an hour from the end of the cycle, the appliance turns off automatically to save energy. Note that some programme/option accords with "Crease Care" system. This means that for some hours, after the end of the drying cycle, the drum rotates at regular intervals to prevent the formation of creases.  
In case of power failure, it is necessary to press the "Start/Pause" button to restart the cycle.

## PUSH & GO

This function serves to start a cycle, after machine switching on, without enabling any further button an/or knob (the programme PUSH & GO will be deactivated instead).

**It is always necessary to follow the points 1, 2, and 3 concerning the daily use.**

To start the cycle PUSH & GO, keep the button pressed. The light on signals that the cycle is started. The cycle is suitable for cotton and synthetic textiles. Max. load 4 kg. (Cycle duration 120')

If the door is opened during the cycle, to restart it, close the door and press the button START/PAUSE. This programme does not allow to set other options.

## OPENING OF THE DOOR DURING THE CYCLE

Laundry can be checked while the drying cycle runs and any garments already dry can be removed, while drying continues for the remaining items. After closing the door, press the "Start/Pause" button to resume machine operation.

Keep the door closed until the cycle end to save time and energy.

## CARE LABEL

Always check the care labels, especially when placing garments in the tumble dryer for the first time. Below are the most commonly used symbols:

- May be tumble dried.
- Do not tumble dry.
- Tumble dry – high heat.
- Tumble dry – low heat.

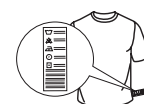



## PROGRAMMES

The duration of these programs will depend on the size of the load, types of textiles, the spin speed used in your washer and any extra options selected. **In machines equipped with display, the duration of the cycles is shown on the control panel.** The remaining time is constantly checked and adjusted during the drying cycle to show the best possible estimate.  
Option to use - If all your loads on Automatic Cycles are consistently less dry or more dry than you would like, you may increase or decrease the dryness level using the specific option.

 **Eco** **kg Max\***  
This is the most efficient programme in terms of energy consumption and is suitable for drying normal wet cotton laundry. The values on the Energy Label are based on this programme.

**NOTE:** For optimal energy efficiency this cycle by default is set up to "Cupboard Dry" level. For a higher dryness level we suggest using the Cotton cycle.

 **Cotton** **kg Max\***  
Cycle suitable for drying all types of cotton, ready to be placed in the cupboard.

 **Mixed** **kg 4**  
This programme is ideal for drying cotton and synthetic fabrics together.

 **Synthetics** **kg 4**  
For drying laundry made of synthetic fibres.

 **Mini synthetics** **kg 2**  
2kg Eco-drying of small laundry loads.

 **Delicates** **kg 2**  
For drying delicate laundry requiring a gentle treatment.

 **Wool** **kg 1**  
Programme for drying wool clothing. It is advisable to turn the garments inside out before drying. Leave to dry naturally the heaviest edges that are still damp.

 **Refresh**  
A short programme suitable for refreshing fibres and garments by means of fresh air. Do not use with garments that are still wet. It can be used on with any load size but is more effective with small loads. The cycle duration is about 20 minutes.

 **Jeans** **kg 3**  
For drying cotton jeans-wear and garments made of robust cotton, like denim, such as trousers and jackets.

 **Shirts** **kg 3**  
This is a programme for Shirts made from cotton or cotton blend/synthetics.

 **Duvet**  
Programme intended to dry bulky garments, as single duvet.

 **Baby** **kg 2**  
A programme intended to dry garments and linen of new-born babies (cotton and chenille), as well as delicate garments. Do not dry garments having plastic covering.

 **Sport** **kg 4**  
For drying sports garments made of synthetics or cotton blends.

 **Smart iron**  
This cycle relaxes fibres, thus making ironing and folding easier. Suitable for small load of damp or dry cotton and cotton blend fabrics. Not for wet items.

 **Xpress 45'** **kg 1**  
This is a quick timed programme, ideal for drying garments spun at high speed in the washing machine, e.g. the shirts used in a working week.

## OPTIONS

These buttons allow you to personalise the selected programme according to personal requirements.  
Not all options are available for all programmes. Some options may be incompatible with ones you have previously set; if so, you will be alerted by the buzzer and/or blinking indicators. If the option is available, the option indicator will stay on. The programme may retain some options selected in previous drying cycles.

 **Dryness level**  
Press the related button several times to obtain a different level of residual moisture on garments. An indicator signals the level being selected.

 **Iron Dry:** very delicate drying. Items will be more easily ironed immediately after the cycle.

 **Hanger dry:** a level intended for delicate garments ready to be hanged.

 **Cupboard dry:** the garments are ready to be folded and put away.

 **Extra dry:** used for garments to be worn at the end of the cycle.

 **Timed drying**  
This option is to manually set the drying time. Press the corresponding button to set the required time for drying. An indicator on the control panel signals the time being selected.

 **Start delay**  
This option is for delaying the start of the cycle. Press the corresponding button several times to find the required delay. Once the max time is reached, the option is reset by pressing the button again. An indicator on the control panel signals the time being selected. After pressing the "Start/Pause" button, the machine signals the time remaining to the start of the cycle. If the door is opened, press the "Start/Pause" button once the door has been closed.

 **Mute**  
This option turns off all sounds of control panel. Only warnings remain active.

- to activate the option, keep the button pressed until the indicator goes on.
- to disable the option, keep the button pressed until the indicator goes off.

 **Cycle end**  
This option activates a prolonged buzzer at the end of the cycle. Enable it if you are not sure to hear the normal sound at the end of the cycle. This option remains in memory if selected in the previous drying.

 **Key lock**  
This option makes all machine controls inaccessible, except the button On/Off. When the machine is on:

- to activate the option, keep the button pressed until the indicator goes on.
- to disable the option, keep the button pressed until the indicator goes off.

This option remains in memory if selected in the previous drying.

 **Crease care**  
This option add a crease treatment at the end of the cycle by means of a periodic rotation of the drum (duration up to 10 hours). It is particularly suitable when it is not possible to remove the laundry as soon as the drying ends. If this option is used together with the Start Delay, the crease treatment is added also in the Start Delay phase. This option remains in memory if selected in the previous drying.

 **Light dry**  
Enables a more gentle treatment of the laundry by reducing the drying temperature.

**\*MAX LOAD 9 Kg (Dry load)**

## CARE AND MAINTENANCE

**WARNING: unplug the dryer during the cleaning and maintenance procedures.**

 **Emptying the water tank after each cycle (see Fig. A).**

Pull the container out of the dryer and empty it into a sink or other suitable drain, then place it back properly. Do not use the dryer without having inserted the container back in place.

 **Cleaning the door filter after each cycle (see Fig. B).**

Pull the filter out and clean it by removing the lint from the filter surface under running water or using a vacuum cleaner. For optimal performance, dry up all the filters before inserting them back in place. **Do not use the dryer without having reinserted the filter in place.**

Remove the door filter as described below:

1. Open the door and pull upwards.
2. Open the filter and remove lint from all its parts. Replace it correctly. Ensure it is completely inserted flush with the dryer seal.

 **Cleaning the bottom filter when the relevant indicator turns on (see Fig. C).**

Pull the filter out and remove the lint from its surface by washing it under running water or by using a vacuum cleaner. However, it is advisable to clean this filter after each cycle to optimise drying performance. **Do not use the dryer without having inserted the filter in place first.**

Remove the bottom filter as described below:

1. Open the lower door.
2. Take the handle and pull the lower filter out.
3. Open the rear side of the filter and remove the lint from the inner surface of the mesh.
4. Clean the bottom filter chamber avoiding the direct contact with the fins.
5. Close the rear side of the lower filter and place it back by checking it is perfectly integrated in place.
6. Lower the filter handle and close the bottom door.
7. Make sure the air intake is free.

**The filters are essential parts for drying. They are intended to collect the lint formed during drying process. In case of clogged filters, the air flow inside the dryer would be seriously affected: the drying times would be longer, the energy consumption would increase and the dryer could be damaged. If these procedures are not carried out properly, the dryer may not start.**



## Cleaning the tumble dryer

- The external metal, plastic and rubber parts can be cleaned with a damp cloth.
- Clean the front air intake grille regularly (every 6 months) with a vacuum cleaner to remove any lint, fluff or dust deposits. Furthermore, remove any lint deposits from the filters area, using a vacuum cleaner every so often.
- Do not use solvents or abrasives.

## TRANSPORT AND HANDLING

Never lift the dryer by holding it at the worktop.

1. Unplug the dryer.
2. Remove the water from the water tank completely.
3. Make sure that door and water tank are properly closed.
4. If the drain hose is connected to your drainage system, re-connect it to the back of the dryer (see "Installation" section in the Safety Instruction guide).

Power consumption			
off-mode (Po) - Watts	0.42		
left-on mode (Pl) - Watts	2.00		
Programmes	Kg	kWh	Minutes
Eco* 	9	2.13	211
Eco 	4.5	1.19	131
Synthetics	4	0.73	95

\* This is the reference programme for the energy label and suitable to dry normal wet cotton laundry. This is the most efficient programme in terms of energy consumption for drying wet cotton laundry. (Standard/Default starting configuration).

## Heat Pump System

The heat pump contains fluorinated greenhouse gases, contained in a hermetically sealed unit. This sealed unit contains 0.18 kg of the R134a gas. GWP = 604 (1 t CO<sub>2</sub>).

## PRODUCT DESCRIPTION

1. Water Tank
2. Air Intake
3. Bottom filter
4. Door filter

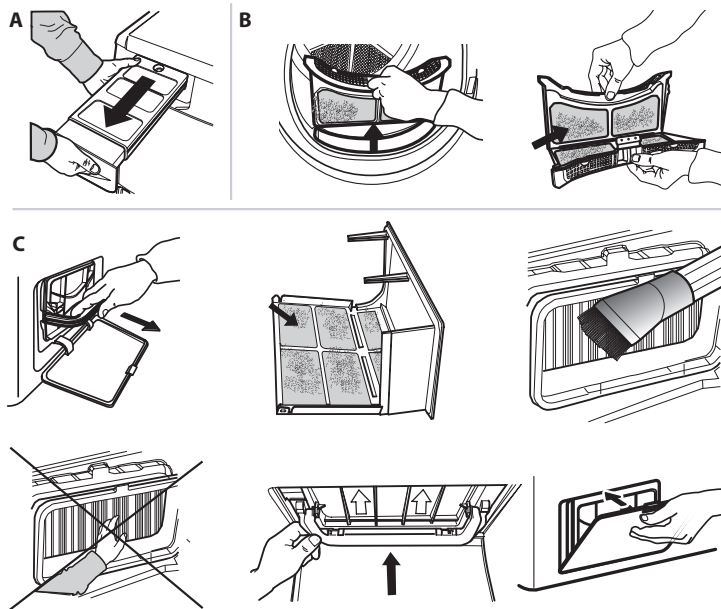
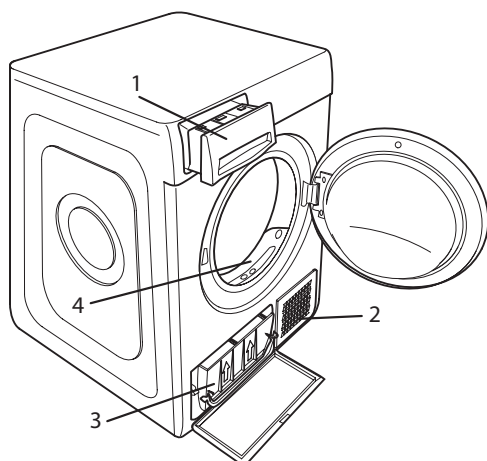

Before contacting the After-sales Service, refer to the table below. Often the malfunctions are minor and can be solved in few minutes.

<b>Malfunction</b>	<b>Possible cause</b>	<b>Solution</b>
The tumble dryer does not turn on.	The plug is not inserted into the socket.	Insert the plug into the socket.
	The plug is faulty.	Try to plug another appliance in the same socket. Do not use connecting electrical devices to the socket, such as adapters or extensions.
	A power failure occurred.	Wait for the power supply to be restored and switch the fuse on again if necessary.
The tumble dryer does not start.	The door has not been closed properly.	Close the door.
	A time delay was set to the start of the cycle.	For machines equipped with this function: wait for the set delay to end or switch the machine off to reset it. Refer to the Options section.
	The "Start/Pause" button was not pressed in order to start the programme.	Press the "Start/Pause" button.
Garments are wet at cycle completion.	The Key Lock function was enabled (for machines equipped with this option).	Refer to the Options section. If Key Lock was selected, disable it. Switching the machine off will not disable this option.
	Small load.	The automatic programme has not sensed the required final moisture so that the dryer completes the programme and stops. If this happens simply select an additional short period of drying or select Extra Dry option if available.
The drying times are very long.	Large loads or heavier fabrics.	Dryness levels can be modified to the specific dryness desired. Extra Dry is recommended for ready to wear items.
	An appropriate maintenance was not carried out.	Refer to the Care & Maintenance section and perform the operations described.
	The programme, the time and/or the drying level set are not suitable for the type and the amount of load inserted into the dryer.	Refer to Programmes and Options sections to find the programme and options most suitable for the type of load.
	The garments are too wet.	Carry out a washing cycle with higher spin speed to remove as much water as possible.
	The dryer may be overloaded.	Refer to the Programmes section to check the max load for each programme.
The programme did not end.	Room temperature.	The drying time may be longer if the room temperature falls outside the 14–30°C range.
	A power failure occurred might have occurred.	In case of power failure, it is necessary to press the "Start/Pause" button to restart the cycle.
<b>Lights on or flashing</b>		
<b>Water tank</b>	The water tank is full.	Empty the water tank. Refer to the Care & Maintenance section.
<b>Door filter</b>	Failure of the air flow necessary for machine operation.	Clean the door filter and check whether air intake is free. Carrying out these operations improperly may cause damages. Refer to Care & Maintenance section.
<b>Bottom filter*</b>	The bottom filter requires cleaning.	Clean the bottom filter. Refer to Care & Maintenance section.
<b>DEMO</b> The cycle lasts few minutes.	The dryer is in DEMO mode. The DEMO indicator is on.	Disable the DEMO mode. The following actions must be carried out in sequence, without breaks. Switch the machine on and then switch it off again. Press the Start/Pause button until the buzzer is heard. Switch the machine on again. The "DEMO" indicator flashes and then turns off.
The presence of wrench symbol signals a malfunction.	The machine sensors detected a failure.	Switch the dryer off and unplug it. Open the door immediately and pull laundry out, to allow the heat to dissipate. Wait for about 15 minutes. Reconnect the dryer to the power supply, load the laundry and restart the drying cycle. <b>If the problem still occurs, contact the After-Sales Service Centre and communicate the letters and digits flashing on the display. For instance: F3 and E2.</b>

\*Note: some models are auto-cleaning and not equipped with bottom filter. Please refer to the Care & Maintenance section.



**Policies, standard documentation, ordering of spare parts and additional product information can be found by:**

- Visiting our website [docs.indesit.eu](https://docs.indesit.eu) and [parts-selfservice.whirlpool.com](https://parts-selfservice.whirlpool.com)
- Using QR Code
- Alternatively, **contact our After-sales Service** (See phone number in the warranty booklet). When contacting our After-sales Service, please state the codes provided on your product's identification plate.

