



THANK YOU FOR BUYING A WHIRLPOOL PRODUCT.
In order to receive a more complete assistance, please register
your product on our website: www.whirlpool.it/register



Before using the appliance carefully read the Safety Instructions.

CONTROL PANEL

- 1 ON/OFF button (Reset if long pressed)
- 2 Programme selection Knob
- 3 Start/Pause

Options buttons*

- 4 Dryness level
- 5 Timed drying
- 6 Start delay
- 7 Rapid
- 8 FreshCare+ (Key lock if long pressed)
- 9 Cycle end

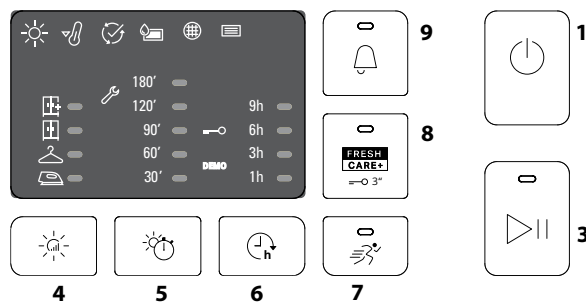
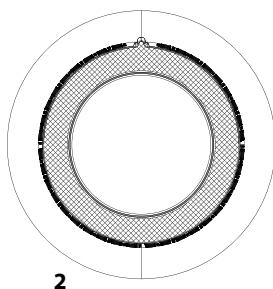

*Note: some models may have the wording in full instead of the icons.

INDICATORS

Dryness level: ☀ Iron dry - 🧥 Hanger dry - 📦 Cupboard dry - 📦 Extra dry

Cycle phase: ☀ Drying - 🧺 Cool down - 🔄 End of cycle

Empty water tank - 🌐 **Clean door filter** - 📖 **Clean bottom filter** -

Refer to troubleshooting section: 🛠 **Failure:** Call after sales service **DEMO Demo mode**

FIRST TIME USE

Make sure that the water tank is correctly inserted. Make sure that the drain hose on the back of the dryer is fixed correctly, either to the dryer's water tank, or to your domestic drainage system.

OPENING OF THE DOOR DURING THE CYCLE

Laundry can be checked while the drying cycle runs and any garments already dry can be removed, while drying continues for the remaining items. After closing the door, press the "Start/Pause" button to resume machine operation. Keep the door closed until the cycle end to save time and energy.

DAILY USE

Doing this will keep your machine working at its BEST:

- remember to empty your water tank after each drying cycle.
- remember to clean your filters after each drying cycle.

Refer to the Care & Maintenance section.

1. Plug the dryer into the power supply socket.
2. Open the door and load garments; always refer to instructions on clothing labels and the max loads indicated in the programme section. Empty pockets. Make sure garments do not get caught between the door and/or the door filter. Do not load items that are dripping wet. Do not tumble dry large, very bulky items.
3. Close the door.
4. Press the "On/Off" button.
5. Select the most suitable programme for the type of fabric in that load.
6. Select the options, if necessary.
7. Press the "Start/Pause" button to begin drying.
8. At the end of the drying cycle, a buzzer will beep. An indicator on the control panel signals the end of the cycle. Pull the load out immediately to prevent the formation of creases on laundry.
9. Turn the machine off by pressing the "On/Off" button, open the door and pull the clothing out. If the machine is not switched off manually, after about a quarter of an hour from the end of the cycle, the appliance turns off automatically to save energy. Note that some programme/option accords with "Crease Care" system. This means that for some hours, after the end of the drying cycle, the drum rotates at regular intervals to prevent the formation of creases. In case of power failure, it is necessary to press the "Start/Pause" button to restart the cycle.

CARE LABEL

Always check the care labels, especially when placing garments in the tumble dryer for the first time. Below are the most commonly used symbols:

- May be tumble dried.
- Do not tumble dry.
- Tumble dry – high heat.
- Tumble dry – low heat.

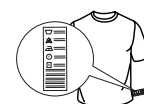

PROGRAMS

The duration of these programs will depend on the size of the load, types of textiles, the spin speed used in your washer and any extra options selected. **In machines equipped with display, the duration of the cycles is shown on the control panel.** The remaining time is constantly checked and adjusted during the drying cycle to show the best possible estimate.

Option to use - If all your loads on Automatic Cycles are consistently less dry or more dry than you would like, you may increase or decrease the dryness level using the specific option.

 **Eco** **kg Max*** **Time 130'**
This is the most efficient programme in terms of energy consumption and is suitable for drying normal wet cotton laundry. The values on the Energy Label are based on this programme.

NOTE: For optimal energy efficiency this cycle by default is set up to "Cupboard Dry" level. For a higher dryness level we suggest using the Cotton cycle.

 **Cotton** **kg Max*** **Time 120'**
Cycle suitable for drying all types of cotton, ready to be placed in the cupboard.

 **Mixed** **kg 4** **Time 100'**
This programme is ideal for drying cotton and synthetic fabrics together.

 **Bed linen** **Kg Max*** **Time 170'**
This programme is intended for drying cotton sheets.

 **Duvet** **Time 240'**
Programme intended to dry bulky items, such as a single duvet.

 **Shirts** **kg 3** **Time 70'**
This is a programme for Shirts made from cotton or cotton blend/synthetics.

 **Jeans** **kg 3** **Time 80'**
For drying sturdy cotton including denim trousers and jackets.

 **Easy ironing**
This cycle relaxes fibres, thus making ironing and folding easier. Suitable for small load of damp or dry cotton and cotton blend fabrics. Not for wet items.

 **Refresh**
A short programme suitable for refreshing fibres and garments through the emission of fresh air. Do not use on wet items. It can be used on with any load size but is more effective with small loads. It lasts about 20 minutes.

 **Rapid 30'** **kg 0,5**
Ideal for drying cotton garments spun at high speed in the washing machine.

 **Sport** **kg 4** **Time 90'**
For drying synthetics or cotton sports garments.

 **Silk** **kg 0,5** **Time 95'**
Gentle drying of silk garments.

 **Wool** **kg 1** **Time 100'**
Programme for drying wool clothes. It is advisable to turn the items inside out before drying. If heavy edges remain damp, leave them to dry naturally.

 **Delicates** **kg 2** **Time 45'**
For drying delicate laundry requiring gentle treatment.

 **Synthetics** **kg 4** **Time 90'**
For drying synthetic fabrics.

OPTIONS

These buttons allow you to personalise the selected programme according to personal requirements. Not all options are available for all programmes. Some options may be incompatible with ones you have previously set; if so, you will be alerted by the buzzer and/or blinking indicators. If the option is available, the option indicator will stay on. The programme may retain some options selected in previous drying cycles.

 **Dryness level**
Press the related button several times to obtain a different level of residual moisture on garments. An indicator signals the level being selected.

 **Iron dry:** very delicate drying. Items will be more easily ironed immediately after the cycle.

 **Hanger dry:** a level intended for delicate garments ready to be hung.

 **Cupboard dry:** the laundry is ready to be folded and put away.

 **Extra dry:** for laundry intended to be worn at the end of the cycle.

 **Timed drying**
This option is to manually set the drying time. Press the corresponding button to set the required time for drying. An indicator on the control panel signals the time being selected.

 **Start delay**
This option is for delaying the start of the cycle. Press the corresponding button several times to find the required delay. Once the max time is reached, the option is reset by pressing the button again. An indicator on the control panel signals the time being selected. After pressing the "Start/Pause" button, the machine signals the time remaining to the start of the cycle. If the door is opened, press the "Start/Pause" button once the door has been closed.

 **Rapid**
Enables quicker drying.

 **FreshCare+**

If laundry is left inside of the drum once the cycle has ended, it can be subjected to bacterial proliferation. This option helps to prevent this from happening by controlling the temperature and gently rotating the drum. This will continue for up to 6 hours after the end of the cycle. This setting will remain in the memory of the previous cycle. If this is used alongside Start Delay, a crease treatment will be performed during this phase by periodic rotations of the drum.

 **Key lock**
This option makes all machine controls inaccessible, except the "On/Off" button. When the machine is on:

- to activate the option, keep the button pressed until the machine signals that the option has been enabled.
- to disable the option, keep the button pressed until the machine signals that the option has been disabled.

This option remains in memory if selected in previous drying.

 **Cycle end**
This option activates a prolonged buzzer at the end of the cycle. Enable it if you are not sure to hear the normal sound at the end of the cycle. This option remains in memory if selected in the previous drying.

***MAX LOAD 8 Kg (Dry load)**

CARE AND MAINTENANCE

WARNING: unplug the dryer during the cleaning and maintenance procedures.

Emptying the water tank after each cycle (see Fig. A).

Pull the container out of the dryer and empty it into a sink or other suitable drain, then place it back properly. Do not use the dryer without having inserted the container back in place.

Cleaning the door filter after each cycle (see Fig. B).

Pull the filter out and clean it by removing the lint from the filter surface under running water or using a vacuum cleaner. For optimal performance, dry up the filter before inserting it back in place.

Do not use the dryer without having reinserted the filter in place.

Remove the door filter as described below:

1. Open the door and pull the filter upwards.
2. Open the filter and remove the lint from all its parts. Replace the filter correctly making sure it is fully seated.

Cleaning the bottom filter when the relevant indicator turns on (see Fig. C).

Pull the filter out and remove the lint from its surface by washing it under running water or by using a vacuum cleaner.

However, it is advisable to clean this filter after each cycle to optimise drying performance.

Do not use the dryer without having reinserted the filter in place.

Remove the bottom filter and the condenser as described below:

1. Open the bottom cover;
2. Take the handle and pull the filter out.
3. Open the rear side of the filter and remove the lint from the inner surface of the mesh.
4. Clean the filter chamber (there might be residual water: this is normal).
5. **Approximately every 3 months, clean the condensing unit (figure D) situated behind the bottom filter.**
 - Lower the levers situated on the sides of the condenser. Pull the handle to remove the condenser and clean it under running water.
 - Put the the condenser back in place and lift the levers.
6. Close the rear side of the filter and place it back by checking it is perfectly integrated in place.
7. Lower the filter handle and close the bottom cover.
8. Make sure the air intake is free.

The filters are essential parts for drying. They are intended to collect the lint formed during drying process. In case of clogged filters, the air flow inside the dryer would be seriously affected: the drying times would be longer, the energy consumption would increase and the dryer could be damaged. If these procedures are not carried out properly, the dryer may not start.



Cleaning the tumble dryer

- The external metal, plastic and rubber parts can be cleaned with a damp cloth.
- Clean the front air intake grille regularly (every 6 months) with a vacuum cleaner to remove any lint, fluff or dust deposits. Furthermore, remove any lint deposits from the filters area, using a vacuum cleaner every so often.
- Do not use solvents or abrasives.

TRANSPORT AND HANDLING

Never lift the dryer by holding it at the worktop.

1. Unplug the dryer.
2. Remove the water from the water tank completely.
3. Make sure that door and water tank are properly closed.
4. If the drain hose is connected to your drainage system, re-connect it to the back of the dryer (see "Installation" section in the Safety Instruction guide).

Power consumption			
off-mode (Po) - Watts			0.13
left-on mode (PI) - Watts			2.00
Programs	Kg	kWh	Minutes
Eco Cotton* 	8	4.72	130
Eco Cotton 	4	2.59	80
Synthetics	4	1.84	90

*This is the reference programme for the energy label and suitable to dry normal wet cotton laundry. This is the most efficient programme in terms of energy consumption for drying wet cotton laundry. (Standard/Default starting configuration).

PRODUCT DESCRIPTION

1. Water Tank
2. Air Intake
3. Bottom filter and condenser
4. Door filter

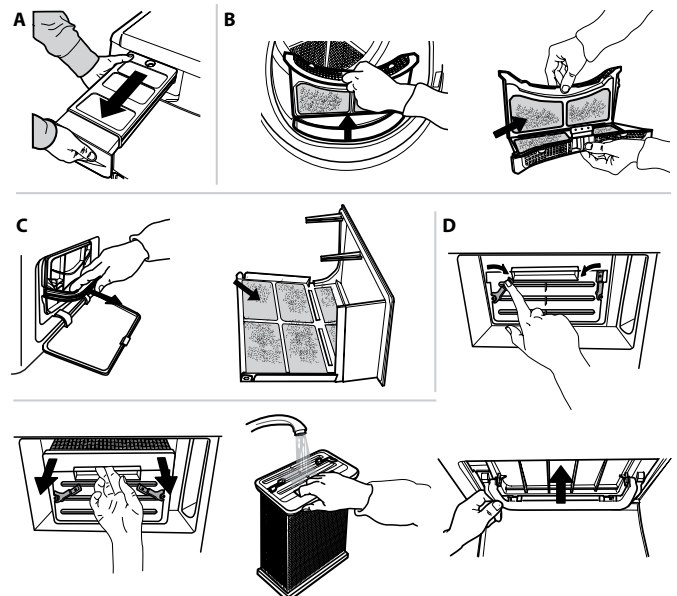
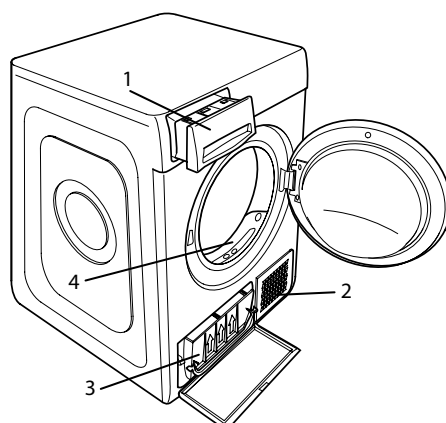

TROUBLESHOOTING

EN

Before contacting the After-sales Service, refer to the table below. Often the malfunctions are minor and can be solved in few minutes.

Malfunction	Possible cause	Solution
The tumble dryer does not turn on.	The plug is not inserted into the socket.	Insert the plug into the socket.
	The plug is faulty.	Try to plug another appliance in the same socket. Do not use connecting electrical devices to the socket, such as adapters or extensions.
	A power failure occurred.	Wait for the power supply to be restored and switch the fuse on again if necessary.
The tumble dryer does not start.	The door has not been closed properly.	Close the door.
	A time delay was set to the start of the cycle.	For machines equipped with this function: wait for the set delay to end or switch the machine off to reset it. Refer to the Options section.
	The "Start/Pause" button was not pressed in order to start the programme.	Press the "Start/Pause" button.
	The Key Lock function was enabled (for machines equipped with this option).	Refer to the Options section. If Key Lock was selected, disable it. Switching the machine off will not disable this option.
Garments are wet at cycle completion.	Small load.	The automatic programme has not sensed the required final moisture so that the dryer completes the programme and stops. If this happens simply select an additional short period of drying or select Extra Dry option if available.
	Large loads or heavier fabrics.	Dryness levels can be modified to the specific dryness desired. Extra Dry is recommended for ready to wear items.
The drying times are very long.	An appropriate maintenance was not carried out.	Refer to the Care & Maintenance section and perform the operations described.
	The programme, the time and/or the drying level set are not suitable for the type and the amount of load inserted into the dryer.	Refer to Programmes and Options sections to find the programme and options most suitable for the type of load..
	The garments are too wet.	Carry out a washing cycle with higher spin speed to remove as much water as possible.
	The dryer may be overloaded.	Refer to the Programmes section to check the max load for each programme.
The programme did not end.	A power failure occurred might have occurred.	In case of power failure, it is necessary to press the "Start/Pause" button to restart the cycle

Lights on or flashing

Water tank	The water tank is full.	Empty the water tank. Refer to the Care & Maintenance section
Door filter	Failure of the air flow necessary for machine operation.	Clean the door filter and check whether air intake is free. Carrying out these operations improperly may cause damages. Refer to Care & Maintenance section.
Bottom filter*	The bottom filter requires cleaning.	Clean the bottom filter. Refer to Care & Maintenance section.
DEMO The cycle lasts few minutes.	The dryer is in DEMO mode. The DEMO indicator is on.	Disable the DEMO mode. The following actions must be carried out in sequence, without breaks. Switch the machine on and then switch it off again. Press the Start/Pause button until the buzzer is heard. Switch the machine on again. The "DEMO" indicator flashes and then turns off.

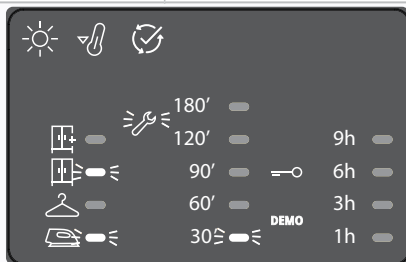

The presence of wrench symbol signals a malfunction. Carry out the operations described. Switch the dryer off and unplug it. Open the door immediately and pull laundry out, to allow the heat to dissipate. Wait for about one hour. Reconnect the dryer to the power supply, load the laundry and restart the drying cycle.

If the problem still occurs, contact the After-Sales Service Centre and communicate the number and the position of the flashing LEDs, starting from the bottom and the left column. e.g.:
First, left column, LEDs No. 1 and 3 on.
Central column, LED No. 1 on.

*Note: some models are auto-cleaning and not equipped with bottom filter. Please refer to the Care & Maintenance section.



Policies, standard documentation, ordering of spare parts and additional product information can be found by:

- Visiting our website docs.whirlpool.eu and parts-selfservice.whirlpool.com
- Using QR Code
- Alternatively, **contact our After-sales Service** (See phone number in the warranty booklet). When contacting our After-sales Service, please state the codes provided on your product's identification plate.

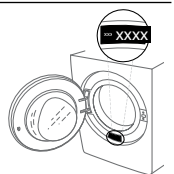

Whirlpool



W11590439

09/2022