

1. Radiant cooking zone Ø 145
2. Radiant cooking zone Ø 210
3. Radiant cooking zone Ø 145
4. Radiant cooking zone Ø 180
5. Residual heat indicator (only on some models)
6. Rear right cooking zone control knob
7. Rear left cooking zone control knob
8. Front left cooking zone control knob
9. Front right cooking zone control knob

- To use the hob turn the knob(s) clockwise and position it (them) on the required power setting.
- To turn the hob off, turn the knob(s) back to position "0".
- On some models there are the residual heat indicators. These light up when the cooking zones reach temperatures that could cause burns. These indicators remain alight after the cooking zone is switched off, and turn off only when the zones are no longer hot enough to be dangerous.

Important:

To avoid permanently damaging the glass-ceramic top, do not use:



- Pots with bottoms that are not perfectly flat.
- metal pots with enamelled bottom.

DIMENSIONS OF THE COOKTOP AND WORKTOP (mm)

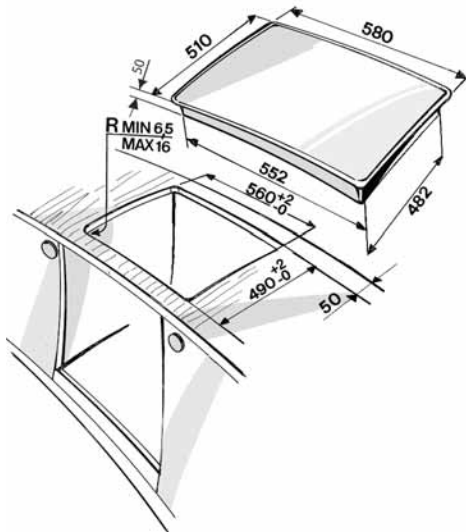
Make sure that the voltage indicated on the rating plate is the same as the mains voltage. Technical data is given on the rating plate on the edge of the hob and also below:



ELECTRICAL CONNECTION

Power supply voltage	Cables (number and size)
230 V ~ 	3 X 2.5 mm ²
230 V 3 ~ + 	4 X 1.5 mm ²
400 V 2N ~ + 	4 X 1.5 mm ²

IMPORTANT SAFETY INSTRUCTIONS YOUR SAFETY AND THAT OF OTHERS IS VERY IMPORTANT

This manual and the appliance itself provide important safety messages, to be read and always observed.

WARNING:

All messages relevant to safety specify the potential risk to which they refer and indicate how to reduce the risk of injury, damage and electric shocks due to incorrect use of the appliance. Make sure to comply with the following:

The appliance must be disconnected from the power supply before carrying out any installation operation.

- The appliance must be earthed.
- The power cable must be long enough for connecting the appliance, fitted in the cabinet, to the power supply.
- For installation to comply with the current safety regulations, an omnipolar switch with minimum contact gap of 3mm is required.
- Do not use multi-sockets or extension cords.
- Do not pull the appliance's power cable.
- The electrical parts must not be accessible to the user after installation.
- The appliance is designed solely for domestic use for cooking food. No other use is permitted (e.g. heating rooms). The Manufacturer declines any liability for inappropriate use or incorrect setting of the controls.
- The appliance and its accessible parts become hot during use. Care should be taken to avoid touching heating elements. Children less than 8 years old shall be kept away unless continuously supervised.
- The accessible parts can become very hot during use. Children must be kept away from the appliance and watched over to ensure they do not play with it.
- Do not touch the appliance heating elements during and after use. Do not allow the appliance to come into contact with cloths or other flammable materials until all the components have cooled sufficiently.
- Do not place flammable materials on or near the appliance.
- Overheated oils and fats catch fire easily. Pay attention when cooking food products rich in fat and oil.
- This appliance can be used by children aged from 8 years and above and persons with reduced physical, sensory or mental capabilities or lack of experience and knowledge if they have been given supervision or instruction concerning use of the appliance in a safe way and understand hazards involved. Cleaning and user maintenance shall not be made by children without supervision.
- If the surface is cracked, switch off the appliance to avoid the possibility of electric shock.
- The appliance is not intended to be operated by means of an external timer or separate remote control system.
- Unattended cooking on a hob with fat or oil can be dangerous and may result in fire. NEVER try to extinguish a fire with water, but switch off the appliance and then cover flame e.g. with a lid or a fire blanket. Danger of fire: do not store items on the cooking surfaces.
- Do not use steam cleaners.
- Metallic objects such as knives, forks, spoons and lids should not be placed on the hob surface since they can get hot.

BEFORE USING THE COOKING HOB

Before use, remove:

- adhesives stuck on the hob;
- cardboard guards and protective plastic film;
- check whether the hob has been damaged during transport. If in doubt, contact the After Sales Service.

Care and maintenance

- Clean the hob, when it is cool, after each use. This will prevent the build-up of dirt and make cleaning easier.
- Use a clean cloth, absorbent kitchen wipes and washing up liquid or a specific glass ceramic cleaner.
- Remove baked-on dirt with the special scraper tool (if provided) and specific cleaning products.
- Any food spills should be cleaned off before they dry.
- Do not use abrasive products, chlorine-based cleaners, oven-cleaner spray or pan scourers.
- The hob should be treated periodically with specific products available from the shops, following the manufacturer's instructions.

TROUBLESHOOTING GUIDE

The hob does not work:

- Make sure that the power supply is on.
- Turn the hob off and on again, to make sure that the problem has been solved.

- Make sure that the knob is not turned to "0". Turn the multi-pole switch to "Off" for a few minutes and then turn it back to "On".

The hob will not switch off:

- disconnect the hob immediately from the power supply.

AFTER SALES SERVICE

Before you call the After Sales Service

- Make sure that you cannot solve the problem yourself following the points described in chapter "Troubleshooting Guide".

If after the above checks the fault still occurs, get in touch with the nearest After Sales Service.

Please give:

- a short description of the fault;
- the exact type and model of hob;
- service number (i.e., the number that follows the word SERVICE on the rating plate under the hob itself);
- your full address;
- your telephone number.

If any repairs are required, please contact an authorised **After Sales Service** (to guarantee that original spare parts will be used and repairs carried out correctly).

Failure to comply with these instructions may compromise

Declaration of conformity

- This cooktop has been designed, constructed and marketed in compliance with:
 - safety objectives of the "Low Voltage" Directive 2006/95/CE (which replaces 73/23/CEE and subsequent amendments).
 - the protection requirements of Directive "EMC" 2004/108/CE.
- This cooktop is suitable for contact with foodstuffs and complies with EEC (CE) Regulation n. 1935/2004.

PROTECTING THE ENVIRONMENT

Disposal of packaging materials

- The packing material can all be fully recycled, as confirmed by the recycling symbol .
- The various parts of the packing must not be sent for waste, but recycled in conformity with the regulations imposed by local authorities.

Disposal of used household appliances

- This appliance is marked according to the European directive 2002/96/EC on Waste Electrical and Electronic Equipment (WEEE). By ensuring this product is disposed of correctly, you will help prevent potential negative consequences for the environment and human health, which could otherwise be caused by inappropriate waste handling of this product.

The symbol  on the product, or on the documents accompanying the product, indicates that this appliance may not be treated as household waste. Instead it shall be handed over to the applicable collection point for the recycling of electrical and electronic equipment. Disposal must be carried out in accordance with local environmental regulations for waste disposal. For more detailed information about treatment, recovery and recycling of this product, please contact your local city office, your household waste disposal service or the shop where you purchased the product.

Energy saving

- Use pots and pans whose bottom diameter is equal to that of the cooker plates, or slightly larger.
- Only use flat-bottomed pots and pans.
- If possible, keep the pot covered when cooking.
- Cook vegetables, potatoes, etc. with little water in order to cut down cooking time.
- A pressure cooker allows you to save even more energy and time.

INSTALLATION

Recommendations

Important: Disconnect the hob from the mains before carrying out any installation work or servicing.

- All electrical connections must be made before connecting the appliance to the power supply.
- Installation must be carried out by a qualified technician in accordance with the manufacturer's instructions and in compliance with local regulations.
- Unpack the hob and make sure that the appliance has not been damaged during transport. **If you are not sure contact the dealer or the nearest service centre.**

Preparing the housing unit

- Cut the worktop to fit before installing the appliance. Carefully remove any shavings or sawdust that could prevent the appliance from running properly.

Attention: to install the hob on other surfaces than wood (marble, plastic, ceramic, marble, stone, etc.) remember to ask After Sales Service for the fixing plates (fig. 2) Code 4819 404 78697.

- The hob must be fitted in a worktop with a minimum thickness of 20 mm and a maximum of 50 mm.
- Insert a separator panel at a minimum distance of 20 mm from the bottom of the hob, so that it cannot be accessed by the user.
- If there is an oven under the hob, make sure that it is manufactured by us and equipped with a cooling system.
- There must be nothing between the hob and the oven (e.g. cables, insulating material, etc.).
- An adjacent column unit must be installed at least 100 mm from the edge of the hob.
- Cut an opening in the worktop of the given dimensions.
- We recommend you seal the internal edges of the worktop with wood glue or silicone.
- If not already in place, apply the supplied seal to the hob, after cleaning the adhesive surface thoroughly.

Glass-ceramic hob

Important: remove any protective film before installing the hob.

Make sure that that the opening in the worktop for the hob is cut according to the dimensions given in the drawing, paying attention to the tolerance range.

The hob should not be forced into the worktop. Forcing the glass-ceramic top may cause it to crack (even at a later date)!

- **If the worktop is made of wood**, use the spring clips and screws provided.

1. Secure the spring clips (A) (fig. 1) with the screws provided (B) (fig. 1) as shown, paying attention to the specified distances.

2. Fit the hob into the worktop.

- **If the worktop is made of marble, plastic, ceramic, stone, etc.**, the hob must be secured with special brackets (C) (fig. 2).

1. Fit the hob into the worktop (fig. 1).
2. Place the 4 brackets (C) in position in accordance with the thickness of the worktop as shown in fig. 2.
3. Fasten the 4 screws (D) in the positions (E) (fig. 2).

Connecting the hob to the power supply

The installer is responsible for connecting appliances correctly to the mains and for observing the safety regulations.

Note: the yellow/green earth wire must be connected to the screw with the symbol .

- Strip approx. 70 mm of the cable sheath from the power supply cable (G).
- Strip approx. 10 mm of sheath from the conductors. Insert the cable (G) through the opening in the lid (F).
- Insert the cable into the cable clamp and connect the conductors to the terminal block as indicated in the diagram printed on the lid.
- Secure the power cable (G) by means of the cable clamp.
- Refit the protection lid (F).
- After the electrical connection, fit the hob from the top and hook it to the fixing springs, according to the illustration.

