

GB User and maintenance manual

Whirlpool

IMPORTANT SAFETY INSTRUCTIONS

These instructions shall also be available on website: docs.whirlpool.eu.

YOUR SAFETY AND THAT OF OTHERS IS VERY IMPORTANT

This manual and the appliance itself provide important safety warnings, to be read and observed at all times.

 This is the attention symbol, pertaining to safety, which alerts users to potential risks to themselves and others.

All safety warnings are preceded by the attention symbol and the following terms:



DANGER:

indicates a hazardous situation which, if not avoided, will cause serious injury.



WARNING:

indicates a hazardous situation which, if not avoided, could cause serious injury.

All safety warnings specify the potential danger/warning to which they refer and indicate how to reduce the risk of injury, damage and electrical shock resulting from incorrect use of the appliance. Comply with the following instructions:

- Installation or maintenance must be carried out by a specialized technician, in compliance with the manufacturer's instructions and local safety regulations. Do not repair or replace any part of the appliance unless specifically requested in the user manual.
- The appliance must be disconnected from the power supply before carrying out any installation work.
- Earthing of the appliance is compulsory. (Not necessary for class II hoods identified by the  symbol on the specifications label).
- The power supply cable must be long enough to permit connecting the appliance to the mains socket outlet.
- Do not pull the power supply cable in order to unplug the appliance.
- The electrical components must no longer be accessible to the user after installation.
- Do not touch the appliance with any wet part of the body and do not operate it when barefoot.
- This appliance may be used by children older than 8 years of age and by persons with reduced physical, sensory or mental capacities or with inadequate experience and knowledge only if they are supervised or if they have been taught how to use the appliance in conditions of safety and if they are aware of the dangers involved. Children must not play with the appliance. Cleaning and maintenance must not be carried out by children, unless they are supervised by adults.
- Do not repair or replace any part of the appliance unless specifically indicated in the manual. Defective parts must be replaced using genuine parts. All other maintenance services must be carried out by a specialized technician.
- Children must be supervised to ensure they do not play with the appliance.
- When drilling through a wall or the ceiling, pay attention not to damage electric connections and/or pipes.
- The ventilation ducts must always discharge to the outside.

- Exhaust air must not be vented through a flue used for removal of fumes produced by appliances burning gas or other fuels, but must have a separate outlet. All national regulations governing extraction of fumes must be observed.
- If the hood is used together with other appliances operating on gas or other fuels, the negative pressure in the room must not exceed 4 Pa (4×10^{-5} bar). For this reason, make sure the room is adequately ventilated.
- The Manufacturer declines any liability for improper use or incorrect setting of the controls.
- Regular cleaning and maintenance is essential to correct functioning and good performance of the appliance. Frequently clean all encrustations from dirty surfaces to prevent the accumulation of grease. Regularly clean or replace the filters.
- Failure to observe the instructions for cleaning the hood and replacing the filters may result in a fire.
- The fume extractor hood must never be opened without the grease filters installed and it should be kept under constant supervision.
- Gas appliances must be used under the extractor hood only with pans resting.
- When using more than three gas cooking points, the hood should be operating at power level 2 or greater. This will eliminate heat congestion in the appliance.
- Before touching the bulbs, first ensure that they are cold.
- Do not use or leave the hood without its lamps correctly installed - risk of electric shock.
- Wear work gloves for all installation and maintenance operations.
- The product is not suitable for outdoor use.
- When the hob is in use, accessible parts of the hood may become hot.
- For lamp replacement use only lamp type indicated in the Maintenance/Replacing lamps section of this manual.

KEEP THIS BOOKLET FOR FUTURE CONSULTATION.

Declaration of Conformity

- This appliance has been designed, manufactured and marketed in compliance with:
 - the ecodesign requirements of european regulations n. 66/2014, n. 327/2011, n. 244/2009, n. 245/2009, n.1194/2012, n. 2015/1428;

Electrical safety of the appliance can only be guaranteed if it is correctly connected to an approved earthing system.

Energy saving tips

- Switch ON the hood at minimum speed when you start cooking and kept it running for few minutes after cooking is finished.
- Increase the speed only in case of large amount of smoke and vapour and use boost speed(s) only in extreme situations.
- Replace the charcoal filter(s) when necessary to maintain a good odour reduction efficiency.
- Clean the grease filter(s) when necessary to maintain a good grease filter efficiency.
- Use the maximum diameter of the ducting system indicated in this manual to optimize efficiency and minimize noise.

INSTALLATION

After unpacking the appliance, check for any transport damage. In the event of problems, contact the dealer or your nearest After-sales Service. To prevent any damage, only remove the appliance from its polystyrene foam packaging at the time of installation.

PREPARING FOR INSTALLATION



WARNING:

this is a heavy product; the hood should only be lifted and installed by two or more people.

The minimum distance between the support of the cooking pans on top of the cooker and the bottom of the hood must not be less than 50 cm for electric cookers and 65 cm for gas or mixed cookers. Before installation also check the minimum distances stated in the manual of the cooker.

If the installation instructions for the cooker specify a greater distance between cooker and hood, this distance must be observed.

ELECTRICAL CONNECTION

Make sure the power voltage specified on the appliance rating plate is the same as the mains voltage.

This information may be found on the inside of the hood, under the grease filter.

Power cable replacement (type H05 VV-F 3 x 0,75 mm²) must be carried out by a qualified electrician. Contact an authorized service centre.

If the hood is fitted with an electric plug, connect the plug to a socket complying with current regulations, located in an accessible place after installation. If no plug is fitted (direct wiring to the mains), or if the socket is not located in an accessible place, install a standardised double pole power switch that will enable complete isolation from the mains in case of category III overvoltage conditions, in accordance with installation rules.

GENERAL RECOMMENDATIONS

Before use

Remove cardboard protection pieces, protective film and adhesive labels from accessories. Check the appliance for any transport damage.

During use

To avoid any damage do not place any weights on the appliance. Do not expose the appliance to atmospheric agents.

SAFEGUARDING THE ENVIRONMENT

Disposal of packing

The packing material is 100% recyclable and is marked with the recycle symbol . The various parts of the packing must therefore be disposed of responsibly and in full compliance with local authority regulations governing waste disposal.

Scrapping the product

- This appliance is marked in compliance with European Directive 2002/96/EC, Waste Electrical and Electronic Equipment (WEEE).
- By ensuring this product is disposed of correctly, you will help prevent potential negative consequences for the environment and human health, which could otherwise be caused by inappropriate waste handling of this product.
- The symbol  on the product or on the accompanying documentation indicates that it should not be treated as domestic waste but must be taken to an appropriate collection centre for the recycling of electrical and electronic equipment.

Scrapping of household appliances

- This appliance is manufactured with recyclable or reusable materials. Dispose of it in accordance with local waste disposal regulations. Before scrapping, cut off the power supply cable.
- For further information on the treatment, recovery and recycling of household electrical appliances, contact your competent local authority, the collection service for household waste or the store where you purchased the appliance.

TROUBLESHOOTING GUIDE

The appliance does not work:

- Check for the presence of mains electrical power and if the appliance is connected to the electrical supply;
- Turn off the appliance and restart it to see if the fault persists.

The hood's suction level is not sufficient:

- Check the suction speed and adjust as necessary;
- Check that the filters are clean;
- Check the air vents for any obstructions.

The light does not work:

- Check the light bulb and replace if necessary;
- Check that the light bulb has been correctly fitted.

AFTER-SALES SERVICE

Before calling the After-sales Service:

1. See if you can solve the problem yourself with the help of the suggestions given in the "Troubleshooting guide".
2. Switch the appliance off and back on again to see if the fault persists.

If after the above checks the fault still occurs, get in touch with the nearest After-sales Service.

Always specify:

- A brief description of the fault;
- The exact type and model of the appliance;
- The service number (number after the word "Service" on the rating plate), located on the inside of the appliance. The service number is also indicated on the guarantee booklet;
- Your full address;
- Your telephone number.

SERVICE 0000 000 00000



If any repairs are required, please contact an **authorised After-sales Service** (to guarantee that original spare parts will be used and repairs carried out correctly).

CLEANING



WARNING:

- **Never use steam cleaning equipment.**
- **Disconnect the appliance from the power supply**

IMPORTANT: do not use corrosive or abrasive detergents. If any of these products accidentally comes into contact with the appliance, clean immediately with a damp cloth.

- Clean the surfaces with a damp cloth. If it is very dirty, add a few drops of washing up detergent to the water. Finish off with a dry cloth.

IMPORTANT: do not use abrasive sponges or metallic scrapers or scourers. Over time, these can ruin the enamel surface.

- Use detergents specifically designed for cleaning the appliance and follow the manufacturer instructions.

IMPORTANT: clean the filters at least monthly to remove any oil or grease residuals.

MAINTENANCE



WARNING:

- Use protective gloves.
- Disconnect the appliance from the power supply

GREASE FILTERS

The metal grease filter has an unlimited life and should be cleaned once a month by hand or in a dishwasher at low temperature and with a short cycle. Cleaning in a dishwasher may cause discolouring of the grease filter, but its filtering efficiency is unaffected.

Pull out the handle to remove the filter.

Wash the filter and leave it to dry, proceeding in reverse order to refit it.

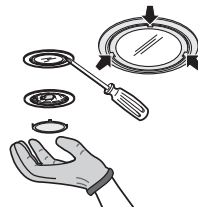
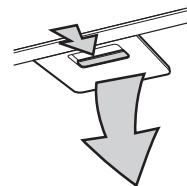

REPLACING HALOGEN LAMPS

1. Disconnect the hood from the household power supply.
2. Use a small screwdriver to gently prise (near the three points indicated) the lamp cover off.
3. Remove the burnt-out lamp and fit a new one.

Lamp	Power (W)	Socket	Voltage (V)	Dimension (mm)	ILCOS D Code (according IEC 61231)
	10	G4	12	10 (Diameter) 22 (Light Center Length)	HSGST/C/UB-10-12-G4-10/22

4. Refit (snap-on) the lamp cover.

ACTIVE CARBON FILTER (filter hoods only):

The carbon filter must be cleaned once a month in a dishwasher at the highest temperature, using a normal dishwasher detergent. It is advisable to clean the filter separately.

After cleaning, reactivate the carbon filter by drying it in the oven at 100°C for 10 minutes.

Change the carbon filter every 3 years.

Fitting the carbon filter:

1. Remove the grease filter.
2. Hook the carbon filter firstly to the metal tab at the back on the hood and then fix it at the front with the two knobs.
3. Refit the grease filter.

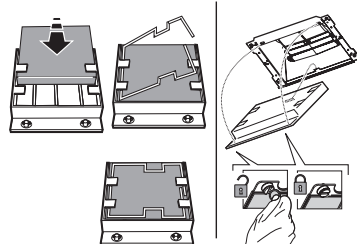

MATERIAL SUPPLIED

Remove all the components from the packets. Check that all the components are included.

- Hood assembled with motor, lamps and grease filters installed.
- Instructions for assembly and use
- 1 electrical cable
- 1 Assembly template
- 6 wall plugs Ø 8mm
- 6 screws Ø 5 x 45
- 1 cable clamp
- 1 screw Ø 3.5 x 9.5
- 1 Flue support bracket
- 2 screws Ø 2.9 x 6.5
- 2 washers
- Filter Version only : 1 deflector + 2 screws Ø 2.9 x 6.5

INSTALLATION - PRELIMINARY ASSEMBLY INSTRUCTIONS

The hood is designed for installation and use in "Extractor version" or in "Filter version".

Note: The model with electric shutter can only be used in "Extractor version" and the exhaust pipe must be connected to a peripheral extraction unit.

Extractor Version

Fumes are extracted and expelled to the outside through an exhaust pipe (not supplied) fixed to the hood exhaust pipe connector.

Depending on the exhaust pipe purchased, provide for suitable fixing to the exhaust pipe connector.

IMPORTANT: If already installed, remove the carbon filter/s.

Filter Version

Air is filtered through the carbon filter/s and recycled into the surrounding environment.

IMPORTANT: check that air recirculation is facilitated.

If the hood does not have a carbon filter/s, order one/them and fit it/them before use.

Install the hood away from very dirty locations, windows, doors and sources of heat.

The hood comes supplied with all the materials required for installation on most walls/ceilings. However, a qualified technician is needed to make sure that the plugs are suitable for your ceiling.

INSTALLATION DIMENSIONS

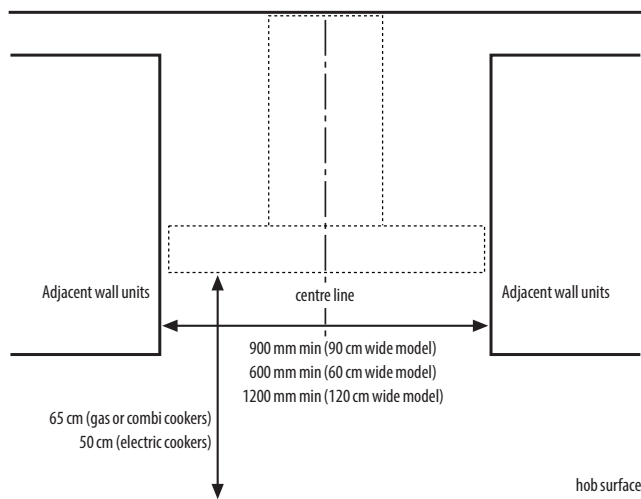

INSTALLATION - ASSEMBLY INSTRUCTIONS

The instructions below, to be carried out in the order in which they are numbered, refer to the figures (with the same step numbers) given on the last pages of this manual.

Note: Some instructions differ depending on the product width or hood box height, in which case installation differences are given in the text and in the figures.

1. Mark a line on the wall, up to the ceiling, corresponding to the centre line.
2. Place the drilling template against the wall (fix it with adhesive tape): the vertical centre line on the template must match the centre line drawn on the wall, and the bottom edge of the drilling template must match the bottom edge of the hood.

Drill a hole.

3. Remove the drilling template and insert plugs and screws as indicated.
4. Tighten a little
5. Place the flue support bracket on the wall, against the ceiling. Drill and insert the wall plugs as indicated. Fix the bracket.
6. **Extractor Version only** - rear exhaust: Make a hole in the rear wall for the flue pipe.
7. **Extractor Version only** - exhaust towards the ceiling: Make a hole in the ceiling for the flue pipe.
8. Prepare the connection to the household electrical system.
9. **Filter Version only:** Fix the deflector to the flue support bracket.
10. Remove the grease filter/s.
11. Remove the tape fixing the control electronics box to the motor body.

Note: The drawing is only a guide, and the box may be temporarily fixed to other sides of the motor body.

12. Hook the hood to the wall.
13. Adjust the hood horizontally.
14. Adjust the distance between the hood and the wall.
15. Mark the hole/s for final fixing of the hood as indicated.
16. Remove the hood from the wall.
17. Drill and insert the wall plugs as indicated.
18. Rehook the hood to the wall.
19. Secure the hood to the wall with screws as indicated.
20. Tighten down the already partially tightened screws fixing the box to the motor body.

Note: There are two types of boxes, with front or rear fixing. Follow the instructions in the figures (20a and 20b) according to your model.

21. Insert the power cable in its special place.
22. Secure the cable to the cable clamp.

IMPORTANT: This operation is compulsory. It will prevent accidental disconnection of the power cable.

Carry out the connection to the household electrical system.

23. Connect the fume exhaust pipe to the collar; the pipe must be run towards the outside (extractor version) or towards the deflector (filter version).
24. Fit the flues in place over the hood, completely covering the extractor unit.
25. Remove the upper section and fix the flues with the screws as indicated.
26. Fit the carbon filter (Filter Version only) and refit the grease filter/s.

Check hood operation, referring to the section giving a description of the hood and its use.

DESCRIPTION AND USE OF HOOD

1. Control panel.
2. Grease filters.
3. Halogen lamps.
4. Telescopic flue.

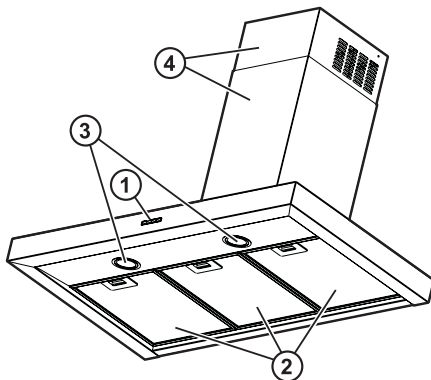

Control panel

1. Motor ON/OFF
2. Speed selection (increase/decrease)

Indicator lights:

- a. running at minimum extraction speed
- b. running at medium extraction speed
- c. running at maximum extraction speed
- d. running at intensive extraction speed

NB = the intensive extraction speed is timed for 5 minutes, after which the motor will revert to medium speed.

3. Light ON/OFF

NB = control backlighting brightness increases when the function is in use.

