

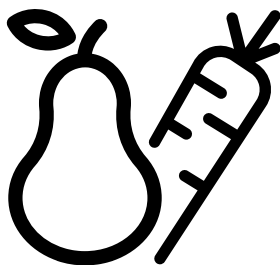

## **No-Frost Refrigerator Freezer**

User manual



# **WHKF 6352 XBR5UK**

®/TM/© 2025 Whirlpool. Produced under license



EN





## THANK YOU FOR BUYING A WHIRLPOOL PRODUCT

In order to receive a more complete assistance, please register your product on [www.register10.eu](http://www.register10.eu)



**PLEASE SCAN THE QR CODE ON YOUR APPLIANCE IN ORDER TO REACH MORE INFORMATION**

### **Please read this user manual first!**

Dear Customer,

We hope that your product, which has been produced in modern plants and checked under the most meticulous quality control procedures, will provide you an effective service.

Therefore, read this entire user manual carefully before using the product and keep it as a reference. If you handover the product to someone else, give the user manual as well.

### **The user manual will help you use the product in a fast and safe way.**

- Read the manual before installing and operating the product.
- Make sure you read the safety instructions.
- Keep the manual in an easily accessible place as you may need it later.
- Read the other documents given with the product.

Remember that this user manual is also applicable for several other models. Differences between models will be identified in the manual.

Please enter following websites [docs.whirlpool.eu](http://docs.whirlpool.eu) & [parts-selfservice.europeanappliances.com](http://parts-selfservice.europeanappliances.com)

### Information

The model's technical information can be retrieved by scanning the QR code on the Energy label and proceeding to the website entering the model identifier.

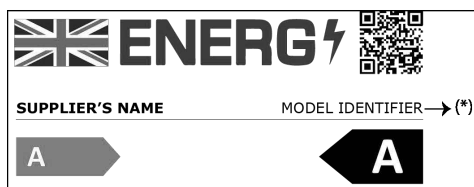
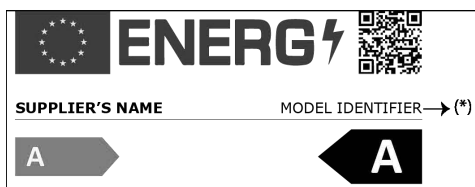

<b><u>1 Environmental Instructions .....</u></b>	<b><u>3</u></b>
<b><u>2 Your Refrigerator.....</u></b>	<b><u>4</u></b>
<b><u>3 Installation .....</u></b>	<b><u>5</u></b>
3.1. Appropriate Installation Location .....	5
3.2. Adjusting the Feet .....	5
3.3. Electrical Connection .....	5
3.4. Removing the baskets .....	6
<b><u>4 Preparation.....</u></b>	<b><u>7</u></b>
<b><u>5 Operating the product .....</u></b>	<b><u>8</u></b>
5.1. Storing into the fresh food compartment .....	10
5.2. Storing into the freezer compartment .....	11
5.3. Changing the illumination lamp .....	12
5.4. Changing the door opening direction ...	12
5.5. Open door warning .....	12
5.6. Freezing fresh food.....	13
5.7. Recommendations for storing frozen foods .....	13
5.8. Deep freezer details .....	14
5.9. Placing the food .....	14
<b><u>6 Maintenance and cleaning .....</u></b>	<b><u>15</u></b>
<b><u>7 Troubleshooting .....</u></b>	<b><u>16</u></b>

# 1 Environmental Instructions

---

## 1.1. Compliance with the WEEE Directive and Disposing of the Waste Product:

This product complies with EU WEEE Directive (2012/19/EU). This product bears a classification symbol for waste electrical and electronic equipment (WEEE).



This symbol indicates that this product shall not be disposed with other household wastes at the end of its service life.

Used device must be returned to official collection point for recycling of electrical and electronic devices. To find these collection systems please contact to your local authorities or retailer where the product was purchased.

Each household performs important role in recovering and recycling of old appliance.

Appropriate disposal of used appliance helps prevent potential negative consequences for the environment and human health.

## 1.2. Compliance with RoHS Directive

The product you have purchased complies with EU RoHS Directive (2011/65/EU). It does not contain harmful and prohibited materials specified in the Directive.

## 1.3. Package information

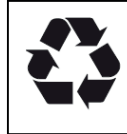

Packaging materials of the product are manufactured from recyclable materials in accordance with our National Environment Regulations.

Take them to the packaging material collection points designated by the local authorities.

## 2 Your Refrigerator

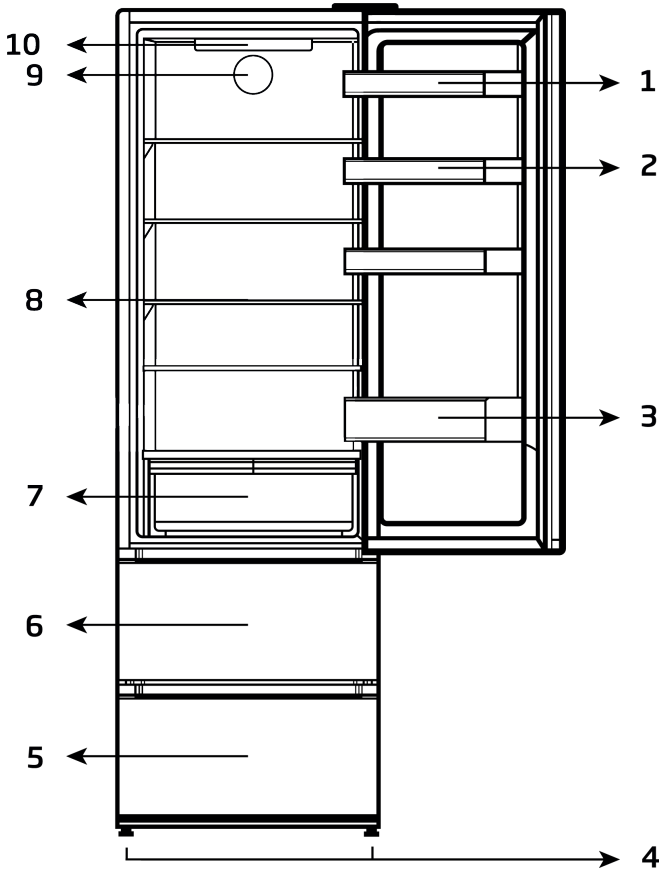

- |                          |                             |
|--------------------------|-----------------------------|
| 1. Egg tray              | 6. Quick Freeze compartment |
| 2. Adjustable shelves    | 7. Crisper                  |
| 3. Bottle shelf          | 8. Adjustable shelves       |
| 4. Adjustable front feet | 9. Fan                      |
| 5. Freezer compartment   | 10. Illumination lamp       |

**\* May not be available in all models**

Figures that take place in this instruction manual are schematic and may not correspond exactly with your product. If the subject parts are not included in the product you have purchased, then it is valid for other models.

## 3 Installation

Read the "Safety Instructions" section first!

### 3.1. Appropriate Installation Location

Contact an Authorized Service for the installation of the product. In order to prepare the product for use, refer the information in the user manual and ensure that electrical installation and water installation are appropriate. If not, call a qualified electrician and technician to have any necessary arrangements carried out.

	<b>WARNING:</b> Manufacturer shall not be held liable for damages that may arise from procedures carried out by unauthorized persons.
	<b>WARNING:</b> Product must not be plugged in during installation. Otherwise, there is the risk of death or serious injury!
	<b>WARNING:</b> If the door clearance of the room where the product shall be place is so tight to prevent passing of the product, remove the door of the room and pass the product through the door by turning it to its side; if this does not work, contact the authorized service.

- Place the product on an even floor surface to prevent jolts.
- Install the product at least 30 cm away from heat sources such as hobs, heater cores and stoves and at least 5 cm away from electrical ovens.
- Product must not be subjected to direct sun light and kept in humid places.
- Appropriate air ventilation must be provided around your product in order to achieve an efficient operation. If the product is to be placed in a recess in the wall, pay attention to leave at least 5 cm distance with the ceiling and side walls.

- Please provide at least 5cm distance for air circulation between the back side of your product and the wall to avoid condensation on the rear panel of product.
- Your product requires adequate air circulation to function efficiently. If the product will be placed in an alcove, remember to leave at least 5 cm clearance between the product and the ceiling, rear wall and the side walls.
- If the product will be placed in an alcove, remember to leave at least 5 cm clearance between the product and the ceiling, rear wall and the side walls. Check if the rear wall clearance protection component is present at its location (if provided with the product). If the component is not available, or if it is lost or fallen, position the product so that at least 5 cm clearance shall be left between the rear surface of the product and the wall of the room. The clearance at the rear is important for efficient operation of the product.

### 3.2. Adjusting the Feet

If the product stands unbalanced after installation, adjust the feet on the front by rotating them to the right or left.

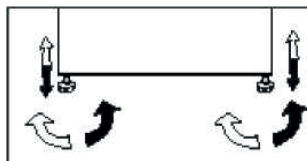

### 3.3. Elektrische aansluiting

	<b>WARNING:</b> Be careful when making connections using extension cables or multiple sockets.
	<b>WARNING:</b> Damaged power cable must be replaced by the Authorized Service Agent.

# Installation

If two coolers are to be installed side by side, there should be at least 4 cm distance between them.

- Our company shall not be liable for any damages that will arise when the product is used without grounding and electrical connection in accordance with the national regulations.
- Power cable plug must be within easy reach after installation.

## Hot Surface Warning!

Side walls of your product is equipped with refrigerant pipes to improve the cooling system. Refrigerant with high temperatures may flow through these areas, resulting in hot surfaces on the side walls. This is normal and does not need any servicing. Please pay attention while touching these areas.

## 3.4. Removing the baskets

### A) Upper basket and pizza tray

To remove both the upper basket and the pizza tray, pull the basket until you fill the click of the extraction position as in the figure below.

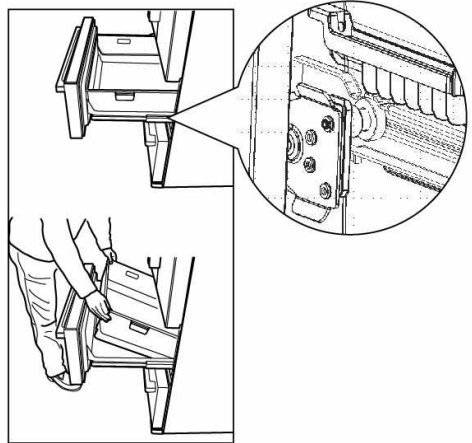
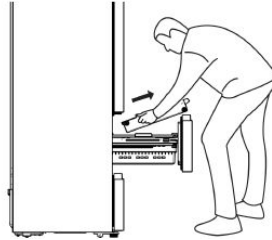

### B) Lower basket

The lower basket cannot be extracted separately, it must be extracted together with the door, as in the figure below.

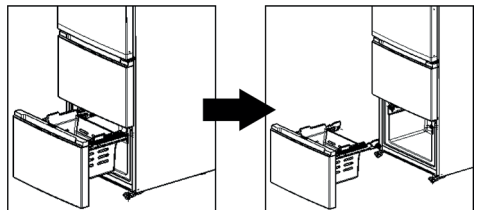

## 4 Preparation

Read the "Safety Instructions" section first!

- For a freestanding appliance; this refrigerating appliance is not intended to be used as a built-in appliance.
  - Your refrigerator should be installed at least 30 cm away from heat sources such as hobs, ovens, central heater and stoves and at least 5 cm away from electrical ovens and should not be located under direct sunlight.
  - The ambient temperature of the room where you install your refrigerator should at least be +5°C. Operating your refrigerator under cooler conditions is not recommended with regard to its efficiency.
  - Please make sure that the interior of your refrigerator is cleaned thoroughly.
  - If two refrigerators are to be installed side by side, there should be at least 2 cm distance between them.
  - When you operate your refrigerator for the first time, please observe the following instructions during the initial six hours.
  - The door should not be opened frequently.
  - It must be operated empty without any food in it.
  - Original packaging and foam materials should be kept for future transportations or moving.
  - The baskets / drawers that are provided with the chill compartment must always be in use for low energy consumption and for better storage conditions.
  - Food contact with the temperature sensor in the freezer compartment may increase energy consumption of the appliance. Thus any contact with the sensor(s) must be avoided.
- In some models, the instrument panel automatically turns off 1 minutes after the door has closed. It will be reactivated when the door has opened or pressed on any key.
  - Due to temperature change as a result of opening / closing the product door during operation, condensation on the door/body shelves and the glass containers is normal.
  - Since hot and humid air will not directly penetrate into your product when the doors are not opened, your product will optimize itself in conditions sufficient to protect your food. Functions and components such as compressor, fan, heater, defrost, lighting, display and so on will operate according to the needs to consume minimum energy under these circumstances.
  - In case of multiple options are present glass shelves must be placed so that the air outlets at the backwall are not blocked, preferably air outlets are remaining below the glass shelf. This combination may help improving air distribution and energy efficiency.

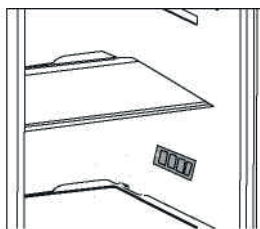

# 5 Operating the product

## Product control panel

- 1 \* Error Status Indicator
- 2 \* Energy Saving (Display Off) Indicator
- 3 \* Wireless Key
- 4 \* Cooler Compartment Temperature Setting Key
- 5 \* Freezer Compartment Temperature Setting Key
- 6 \* Deodoriser Module Key
- 7 \* Quick Freezing Key
- 8 \* Compartment Conversion Key
- 9 \* Cooler Compartment OFF (Vacation) Function
- 10 \* Key for Resetting Wireless Connection Settings

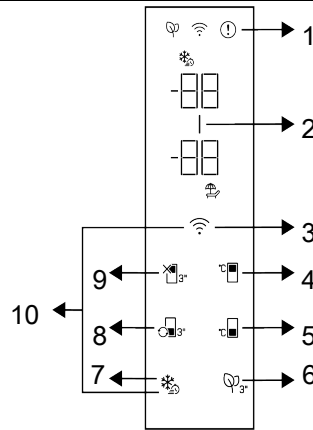

The energy-saving function is a function activated ex-factory and cannot be cancelled.



Read the "Safety Instructions" section first.

### 1. Fault Condition Indicator

This indicator ( ) shall be active when your refrigerator cannot perform adequate cooling or in case of any sensor error. On the freezer compartment temperature indicator the letter "E" and on the cooler compartment temperature indicator the numbers 1, 2, 3 will be displayed. The numbers on the indicator specifies the service regarding the failure. If you place hot food in the freezer compartment or leave its door open for a prolonged time, an exclamation mark can be lit. This is not a fault, this warning shall be removed when the food is cooled down or when any key is pressed.

### 2. Energy Saving (Display Off) Indicator

Energy saving function is enabled automatically and the energy saving symbol ( ) is displayed when the door of the product is not opened or closed for some period of time. When the energy saving function is active, all symbols on the screen other than the energy saving symbol shall be turned off. When the energy-saving function is active, pressing any key or opening the door will deactivate the energy-saving function and the display signals will return to normal.

### \*3. Wireless Key

This button ( ) is utilized to connect wirelessly to your appliance through HomeWhiz mobile application. If the button is pressed for a long time (3 secs) the LED on the button will blink (in 0.5 second intervals). The link between the appliance and the home network is initialized. After the wireless connection with the appliance is established the LED will be lit solid. After initial setup, the connection can be activated/deactivated by pressing this button. The LED on the button shall flash quickly (at 0.2 second intervals) until the connection is established.

### \*4. Cooling Compartment Temperature Setting Key

Allows setting of temperature for cooler compartment ( ). Pressing this key will enable the cooling compartment temperature to be set at 8,7,6,5,4,3,2 and 1 °C .

### \*5. Freezing Compartment Temperature Setting Key

Temperature setting is made for cooler compartment. Pressing ( ) key will enable the freezer compartment temperature to be set at -18,-19,-20,-21,-22,-23,-24 °C.

## \*6. Anti-Odour Module Key

Press this button for 3 seconds to activate/deactivate the anti-odour (  ) feature. As the anti-odour feature is active, the LED on the respective button is lit. When the feature is active, the anti-odour module will be operated periodically.

## 7. Quick Freezing Key

When the quick freeze key is pressed, the LED on the key is illuminated and the quick freeze function shall be activated. Freezing compartment temperature is set to -27 °C. Press the key again to cancel function. The quick freezing function shall be automatically cancelled after 24 hours. To freeze a large amount of fresh food, press the quick freeze key before placing the food in the freezer compartment.

## \*8. Compartment Conversion Key

Pressing compartment conversion key



(  ) for 3 seconds, the freezer section switches between cooler, off and freezer modes. If it is operated as the cooler compartment, the temperature will be set as 4 °C. In case of OFF mode, compartment temperature indicator shall display “- -”.

## 9. Cooling Compartment OFF (Vacation) Function Key

To activate vacation function (  ), press the button for 3 seconds. The vacation mode will be activated and the LED on the button will be lit. “- -” shall be displayed on the Cooling Compartment temperature indicator and the cooling compartment does not actively perform cooling. You shall not keep your food in the cooling compartment when this function is activated. The other compartments continue to cool according to the set temperatures. Press the key for 3 seconds again to cancel this function.

## \*10. Key for Resetting Wireless Connection Settings

To reset wireless connection settings

press Quick freezing (  ), and wireless connection (  ) buttons must be pressed for 3 seconds. On the appliance where the wireless connection settings are reset/ returned to factory defaults, any prior user data set on the appliance is lost.

# Operating the product

## 5.1. Storing into the fresh food

### compartment

- Keep your fridge at recommended temperature level as 4°C.
- Food to be stored should be properly sealed to avoid odour or taste alterations.
- Leave spaces between foods to allow cold air flowing around them to achieve a better and more homogeneous cooling.
- To allow shorter door openings, foods eaten daily should be stored at the front of the shelf.
- Leave a gap between foods and the inner walls, allowing air to flow. If you store foods against the rear wall foods could freeze against rear wall.
- Hot, cooked food must be cooled down at room temperature before storing in the appliance. Then, warm food can be stored in the lower shelves of your fridge.
- Onions, garlic, ginger and other root vegetables should be stored at dark and cool room conditions, not in the fridge.
- Thaw your frozen food in the fresh food compartment. This way, you can use the frozen food to cool down the fresh food compartment and save energy.
- If unripe tropical fruits (mango, melons, papaya, banana, pineapple) are stored in refrigerator, ageing process can be accelerated and it is not advisable since it causes shorter storage times. However, the ripening of strongly green fruits (apple, pear) can be promoted for a certain period in fridge compartment.
- When a spoiled food inside refrigerator is realized, it should be disposed. When rotten food is noticed, please clean inner liner or accessories which were in contact to prevent contamination.
- Large pots of food, such as soups or stews can be divided into shallow containers to quickly cool in the refrigerator. Large pieces of cooked meat and whole poultry should be divided into smaller pieces for the same purpose.
- Keep fruits and vegetables separate and store like with like: apples with apples, carrots with carrots. Fruits and vegetables give off different gases that can cause others to deteriorate.
- Take leafy greens out of plastic bags, wrap them in a paper towel or tea towel before stored in refrigerator.
- Store fruits and vegetables susceptible to drying out in perforated or unsealed plastic bags to maintain a moist environment yet still allow air to circulate.

# Operating the product

- Different foods should be placed in different areas according to their properties:

Please check appropriate Climate Class of your appliance rated on the rating plate. One of below information is valid for your appliance according to rated Climate Class.

- **SN** : Extended Temperate: This refrigerating appliance is intended to be used at ambient temperatures ranging from 10°C to 32°C.
- **N** : Temperate: This refrigerating appliance is intended to be used at ambient temperatures ranging from 16°C to 32°C.
- **ST** : Subtropical: This refrigerating appliance is intended to be used at ambient temperatures ranging from 16°C to 38°C.
- **T** : Tropical: This refrigerating appliance is intended to be used at ambient temperatures ranging from 16°C to 43°C.

Food	Location
Eggs	Door rack
Dairy products (butter, cheese)	If available, biofresh or chiller compartment Lowest shelves.
Fruits, vegetables and salad	Fruit and vegetable box, crisper or EverFresh+ compartment (if available)
Fresh meat, poultry, fresh fish, sausages, cooked foods	If available, biofresh or chiller compartment Lowest shelf
Ready to eat foods, packaged products, canned foods, pickled products	Upper shelves or door rack
Drinks, bottles, condiments, snacks	Door rack
Leftovers	Middle shelves

## 5.2. Storing into the freezer

### compartment

- It is recommended to keep freezer setting at -18°C except extreme ambient conditions.
- 8 hours before freezing switch on the Fast Freeze function to provide faster freezing.
- Hot food must be cooled to room temperature before storing in the freezer compartment.
- Food cut into small portions will freeze faster and be easier to defrost and cook.
- It is better to pack food before putting it into the freezer.
- In order to avoid expiry of storage periods, please note the freezing date, time limit and name of the food on the packaging according to the storage periods of different foods.
- Only take the required amount of food out of the freezer.
- Consume defrosted food quickly. Defrosted food cannot be re-frozen unless it is cooked. It is not safe to consume uncooked re-frozen fresh food.
- When freezing fresh food, avoid bringing it in contact with already frozen food. It may cause thawing of already frozen pieces.

# Operating the product

**When storing commercially frozen foods, please follow these guidelines:**

Always follow manufacturers' guidelines for the length of time you should store the food for.

- Try to keep the length of time between purchase and storage as short as possible to preserve food quality.
- Buy frozen foods, which have been stored at a temperature of -18°C or below.
- Avoid buying food which has ice or frost on the packaging – This indicates that the products might have been partially defrosted and refrozen at some point – temperature rises affect the quality of food.
- We recommend a temperature setting of 4°C for fresh food compartment and -18°C for freezer compartment to achieve better food preservation.
- With the exception of extreme conditions in ambient, if temperature is set to recommended values as +4°C / -18°C, overall freshness will be prolonged within fresh food and freezer compartments. If temperature of fresh food compartment is set to cooler, fresh fruits and vegetables may be partially frozen or exposed to cold injury, while warmer temperature level may cause faster spoilage of highly perishable foods (dairy products, meat products).

## 5.3. Changing the illumination lamp

To change the Bulb / LED used for illumination of your refrigerator, call your AuthorisedService.

The lamp(s) used in this appliance is not suitable for household room illumination.

The intended purpose of this lamp is to assist the user to place foodstuffs in the refrigerator / freezer in a safe and comfortable way.

The lamps used in this appliance have to withstand extreme physical conditions such as temperatures below -20 °C. (only chest and upright freezer)

## 5.4. Changing the door opening direction

Door opening direction of your refrigerator can be changed according to the place you are using it. If this is necessary, please call your nearest Authorized Service.

## 5.5. Open door warning

An audio warning will be given when the fridge or freezer compartment door of your product is left open for a certain period of time. This audio warning signal will mute when any button on the indicator is pressed or when the door is closed.

# Operating the product

## 5.6. Freezing fresh food

- 8 hours before freezing the fresh food activate the Quick Freeze function.
- To preserve food quality, the food items placed in the freezer compartment must be frozen as quickly as possible, use the rapid freezing for this.
- Freezing the food items when fresh will extend the storage time in the freezer compartment.
- Make sure the food items are packed before putting in the freezer. Use freezer holders, tinfoil and damp-proof paper, plastic bag or similar packaging materials instead of traditional packaging paper.
- Pack the food items in air-tight packs and seal tightly.



Ice in the freezing compartment thaws automatically.

- Mark each food pack by writing the date on the package before freezing. This will allow you to determine the freshness of each pack every time the freezer is opened. Keep the earlier food items in the front to ensure they are used first.
- Frozen food items must be used immediately after defrosting and should not be frozen again.

## 5.7. Recommendations for storing frozen foods

The compartment must be set to at least -18°C.

1. Place the food items in the freezer as quickly as possible to avoid defrosting.
2. Before freezing, check the “Expiry Date” on the package to make sure it is not expired.
3. Make sure the food’s packaging is not damaged.

Freezer Compartment Temperature Setting	Cooler Compartment Temperature Setting	Details
-18°C	4°C	This is the default, recommended setting.
-20°C, -22°C or -24°C	4°C	These settings are recommended for ambient temperatures exceeding 30°C.
Quick Freeze	4°C	Use when you want to freeze your food in a short time. When the process ends, the product will regain its position.
-18°C or colder	4°C	Use these settings if you believe the cooler compartment is not cold enough due to ambient temperature or frequently opening the door.

# Operating the product

## 5.8. Deep freezer details

As per the IEC 62552 standards, the freezer must have the capacity to freeze 4,5 kg of food items at -18°C or lower temperatures in 24 hours for each 100 litres of freezer compartment volume.

Food items can only be preserved for extended periods at or below temperature of -18°C .

You can keep the foods fresh for months (in deep freezer at or below temperatures of 18°C).

The food items to be frozen must not contact the already-frozen food inside to avoid partial defrosting.

Boil the vegetables and filter the water to extend the frozen storage time. Place the food in air-tight packages after filtering and place in the freezer.

Bananas, tomatoes, lettuce, celery, boiled eggs, potatoes and similar food items should not be frozen. In case this food rots, only nutritional values and eating qualities will be negatively affected. A rotting threatening human health is not in question.

## 5.9. Placing the food

Freezer compartment shelves	Various frozen goods including meat, fish, ice cream, vegetables etc.
Cooler compartment shelves	Food items inside pots, capped plate and capped cases, eggs (in capped case)
Cooler compartment door shelves	Small and packed food or beverages
Vegetable bin	Fruits and vegetables
Fresh food compartment	Delicatessen (breakfast food, meat products to be consumed in short notice)

## 6 Maintenance and cleaning

---

Read the "Safety Instructions" section first!

We recommend that you unplug the

appliance before cleaning.

For non-No Frost products, water drops

and frosting up to a fingerbreadth occur on the rear wall of the Fridge compartment.

Only use slightly damp microfiber cloths to

clean the outer surface of the product.

Sponges and other types of cleaning cloths may scratch the surface.

Use lukewarm water to clean the cabinet of your refrigerator and wipe it dry.

Use a damp cloth wrung out in a solution of

one teaspoon of bicarbonate of soda to one pint of water to clean the interior and wipe it dry.

Make sure that no water enters the lamp

housing and other electrical items.

If your refrigerator is not going to be used

for a long period of time, unplug the power cable, remove all food, clean it and leave the door ajar.

Check door seals regularly to ensure they

are clean and free from food particles.

To remove door racks, remove all the

contents and then simply push the door rack upwards from the base.

Chlorine causes corrosion on such metal surfaces.

to prevent removal and deformation of the prints on the plastic part. Use lukewarm water and a soft cloth for cleaning and then wipe it dry.

### Protection of plastic surfaces

In case of spilling or smearing oil on the

plastic surfaces, clean and rinse the relevant part of the surface at once with warm water.

## 7 Troubleshooting

Please review this list before calling the service. It will save your time and money. This list includes frequent complaints that are not arising from defective work-manship or material usage. Some of the features described here may not exist in your product.

### The refrigerator does not operate.

- The plug is not inserted into the socket correctly. >>> Insert the plug into the socket securely.
- The fuse of the socket which your refrigerator is connected to or the main fuse have blown out. >>> Check the fuse.

### Condensation on the side wall of the fridge compartment (MULTIZONE, COOL CONTROL and FLEXI ZONE).

- Door has been opened frequently. >>>
- Ambient is very humid. >>>
- 
- Food containing liquid is stored in open containers. >>>
- Door of the refrigerator is left ajar. >>> Close the door of the refrigerator.
- Thermostat is set to a very cold level. >>> Set the thermostat to a suitable level.

### Compressor is not running

- Protective thermic of the compressor will blow out during sudden power failures or plug-out plug-ins as the refrigerant pressure in the cooling system of the refrigerator has not been balanced yet. The refrigerator will start running approximately after 6 minutes. Please call the service if the refrigerator does not startup at the end of this period.
- The fridge is in defrost cycle. >>> This is normal for a full-automatically defrosting refrigerator. Defrosting cycle occurs periodically.
- The refrigerator is not plugged into the socket. >>> Make sure that the plug is fit into the socket.

- Temperature settings are not made correctly >>> Select the suitable temperature value.
- There is a power outage. >>> Refrigerator returns to normal operation when the power restores.

### The operation noise increases when the refrigerator is running.

- The operating performance of the refrigerator may change due to the changes in the ambient temperature. It is normal and not a fault.

### The refrigerator is running frequently or for a long time.

- New product may be wider than the previous one. Larger refrigerators operate for a longer period of time.
- The room temperature may be high. >>> It is normal that the product operates for longer periods in hot ambient.
- The refrigerator might be plugged in recently or might be loaded with food. >>> When the refrigerator is plugged in or loaded with food recently, it will take longer for it to attain the set temperature. This is normal.
- Large amounts of hot food might be put in the refrigerator recently. >>> Doors might be opened frequently or left ajar for a long time. >>> The warm air that has entered into the refrigerator causes the refrigerator to run for longer periods.
- Freezer or fridge compartment door might be left ajar. >>> Check if the doors are closed completely.
- The refrigerator is adjusted to a very low temperature. >>> Adjust the refrigerator temperature to a warmer degree and wait until the temperature is achieved.
- Door seal of the fridge or freezer may be soiled, worn out, broken or not properly seated. >>> Clean or replace the seal. Damaged/broken seal causes the refrigerator to run for a longer period of time in order to maintain the current temperature.

# Troubleshooting

## Freezer temperature is very low while the fridge temperature is sufficient.

- The freezer temperature is adjusted to a very low value. >>> Adjust the freezer temperature to a warmer degree and check.

## Fridge temperature is very low while the freezer temperature is sufficient.

- The fridge temperature is adjusted to a very low value. >>> Adjust the fridge temperature to a warmer degree and check.

## Food kept in the fridge compartment drawers is frozen.

- The fridge temperature is adjusted to a very high value. >>> Adjust the fridge temperature to a lower value and check.

## Temperature in the fridge or freezer is very low.

- The fridge temperature is adjusted to a very high value. >>> Fridge compartment temperature setting has an effect on the temperature of the freezer. Change the temperatures of the fridge or freezer and wait until the relevant compartments attain a sufficient temperature.
- Doors are opened frequently or left ajar for a long time. >>>
- Door is ajar. >>> Close the door completely.
- The refrigerator is plugged in or loaded with food recently. >>> This is normal. When the refrigerator is plugged in or loaded with food recently, it will take longer for it to attain the set temperature.
- Large amounts of hot food might be put in the refrigerator recently. >>>
- 

## Vibrations or noise.

- The floor is not level or stable. >>> If the refrigerator rocks when moved slowly, balance it by adjusting its feet. Also make sure that the floor is strong enough to carry the refrigerator, and level.
- The items put onto the refrigerator may cause noise. >>> Remove the items on top of the refrigerator.

## There are noises coming from the refrigerator like liquid flowing, spraying, etc.

- Liquid and gas flows occur in accordance with the operating principles of your refrigerator. It is normal and not a fault.

## Whistle comes from the refrigerator.

- Fans are used in order to cool the refrigerator. It is normal and not a fault.

## Condensation on the inner walls of refrigerator.

- Hot and humid weather increases icing and condensation. It is normal and not a fault.
- Doors are opened frequently or left ajar for a long time. >>> Close them if they are open.
- Door is ajar. >>> Close the door completely.

## Humidity occurs on the outside of the refrigerator or between the doors.

- There might be humidity in the air; this is quite normal in humid weather. When the humidity is less, condensation will disappear.

## Bad odour inside the refrigerator.

- No regular cleaning is performed. >>> Clean the inside of the refrigerator regularly with a sponge, lukewarm water or carbonate dissolved in water.
- Some containers or package materials may cause the smell. >>> Use a different container or different brand packaging material.
- Food is put into the refrigerator in uncovered containers. >>> Keep the food in closed containers. Microorganisms spreading out from uncovered containers can cause unpleasant odours.
- Remove the foods that have expired best before dates and spoiled from the refrigerator.

## The door is not closing.

- Food packages are preventing the door from closing. >>> Replace the packages that are obstructing the door.
- The refrigerator is not completely even on the floor. >>> Adjust the feet to balance the refrigerator.

## Troubleshooting

- The floor is not level or strong. >>> Make sure that the floor is level and capable to carry the refrigerator.

### **Crispers are stuck.**

- The food is touching the ceiling of the drawer. >>> Rearrange food in the drawer.

### **If The Surface Of The Product Is Hot.**

- High temperatures may be observed between the two doors, on the side panels and at the rear grill while the product is operating. This is normal and does not require service maintenance!

## DISCLAIMER / WARNING

Some (simple failures can be adequately handled by the end-user without any safety issue or unsafe use arising, provided that they are carried out within the limits and in accordance with the following instructions (see the “Self-Repair” section.

Therefore, unless otherwise authorized in the “Self-Repair” section below, repairs shall be addressed to registered professional repairers in order to avoid safety issues. A registered professional repairer is a professional repairer that has been granted access to the instructions and spare parts list of this product by the manufacturer according to the methods described in legislative acts pursuant to Directive 2009/125/EC.

**However, only the service agent (i.e. authorized professional repairers that you can reach through the phone number given in the user manual/warranty card or through your authorized dealer may provide service under the guarantee terms. Therefore, please be advised that repairs by professional repairers (who are not authorized by manufacturer / seller shall void the guarantee.**

### Self-Repair

Self-repair can be done by the end-user with regard to the following spare parts: door handles, door hinges, trays, baskets and door gaskets (an updated list is also available in web as of 1st March 2021.

Moreover, to ensure product safety and to prevent risk of serious injury, the mentioned self-repair shall be done following the instructions in the user manual for self-repair or which are available in web. For your safety, unplug the product before attempting any self-repair.

Repair and repair attempts by end-users for parts not included in such list and/ or not following the instructions in the user manuals for self-repair or which are available in web, might give raise to safety issues not attributable to manufacturer / seller, and will void the warranty of the product.

Therefore, it is highly recommended that end-users refrain from the attempt to carry out repairs falling outside the mentioned list of spare parts, contacting in such cases authorized professional repairers or registered professional repairers. On the contrary, such attempts by end-users may cause safety issues and damage the product and subsequently cause fire, flood, electrocution and serious personal injury to occur.

By way of example, but not limited to, the following repairs must be addressed to authorized professional repairers or registered professional repairers: compressor, cooling circuit, main board, inverter board, display board, etc.





