



IMPORTANT SAFETY INFORMATION

This manual contains important information regarding safety, the use and maintenance of your new hob. Read the manual and keep it in an easily accessible place for future consultation.

Precautions and Advice

1. This cooktop complies with all applicable safety and electromagnetic compatibility legislation. However, individuals fitted with a heart pacemaker should maintain a safe distance from the appliance. This is because it is not possible to guarantee that all pacemakers on the market comply with the standards in compliance with which this appliance was tested so it is not possible to provide an absolute guarantee of the absence of potentially harmful interference.
2. Disposal of packaging materials: dispose of the various packing materials responsibly, in full compliance with local authority regulations governing waste disposal.
3. This induction hob is designed solely for use as a domestic appliance. No other type of use is permitted. The manufacturer declines all responsibility for inappropriate use.
4. The appliance is not intended for use by people (children included) with physical, sensory or mental impairment or without experience and knowledge of the appliance, unless supervised or previously instructed in its use by those responsible for their safety.
5. The cooking zones become extremely hot during use: keep children away from the appliance to avoid the risk of scalding or burns.
6.  The letter "H" will appear on the control panel display to indicate "residual heat" in the corresponding cooking zone: the temperature of the cooking zone is above 60 °C: do not touch the cooking zone or place any object on it while the letter "H" remains lit.
7. If the surface of the hob should become damaged (cracked or broken glass), do not use the appliance and call the After-sales Service immediately.
8. Any repairs or work on the appliance must be carried out by a qualified technician.
9. This hob is equipped with a thermoprotector to prevent the risk of its internal circuits being damaged by high temperatures from external heat sources (e.g. an undercounter oven). If the temperature of the electronic circuits exceeds the safety threshold, the

thermoprotector activates, automatically switching off the hob. The display shows an error message (see. section "Troubleshooting Guide"). When the temperature returns to within normal levels the hob is able to be switched on again.

10. Make sure the cooking zones and the bottoms of pots are dry before use.
11. Do not place metal objects such as kitchen utensils (knives, forks, spoons, ...), lids or other similar items on the cooking zones as they can become very hot.
12. Be extremely vigilant when cooking food with boiling oil or fat since these can catch fire. In the event of oil catching fire, never attempt to put it out with water: switch the hob off and cover the pot immediately with a lid; leave the pot on the cooking zone to cool down. Dispose of the oil in compliance with current regulations.
13. When you finish cooking, press button .

Before use



Important: The induction cooking zones will not switch on if pots and pans are not of the correct dimensions. Only use pots bearing the symbol "INDUCTION SYSTEM" (See figure opposite). Before switching the hob on, position the pot on the desired cooking zone.



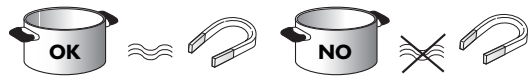





Existing pots and pans:



Use a magnet to check whether pots or pans are suitable for use on the induction hob: pots are unsuitable if they cannot be magnetically detected.

1. Ensure pots have a smooth bottom, otherwise they may scratch the hob's glass ceramic surface. Check dishes.
2. Do not use empty pots on the hob, especially enamelled or aluminium ones. This could result in damage to both the glass ceramic surface and the bottom of the pots.
3. Never place hot pots or pans on the hob's control panel. This could result in damage.

Recommended diameters of pot bottoms

 XL Ø 26 cm		Ø 17 cm → 26 cm	 M Ø 18 cm		Ø 12 cm → 18 cm
 L Ø 21 cm		Ø 14 cm → 21 cm	 S Ø 14,5 cm		Ø 9 cm → 14,5 cm

(Save these instructions)



INSTALLATION and ELECTRICAL CONNECTION



WARNING! Installation must be carried out by a qualified electrician who is fully aware of current safety and installation regulations. The manufacturer declines all liability for injury to persons or animals and for damage to property resulting from failure to observe the regulations provided in this chapter.

Electrical connections

- Hob electrical connection must be made before connecting the appliance to the electricity supply.
- Electrical connection must be carried out in compliance with the regulations of the local electric utility company.
- Make sure that the voltage indicated on the rating plate on the underside of the appliance corresponds to the domestic power supply voltage.
- Regulations require that the appliance is earthed: use conductors (including the earth conductor) of the appropriate size only.
- For electrical connection, use an H05 RR-F type cable as specified in the table "Power supply voltage".

Connecting to the terminal board

Connect the yellow/green earth wire to the terminal with the symbol . This wire must be longer than the other wires.

1. Remove the terminal block cover (A), undoing the screw and inserting the cover in the terminal block hinge (B).
2. Strip approx. 70 mm of sheath from the power supply cable.
3. Strip approx. 10 mm of sheath from the wires. Insert the power supply cable into the cable clamp and connect the wires to the terminal board as indicated in the diagram next to the terminal board itself.
4. Secure the power cable with the cable clamp.
5. Close the cover (C) and screw it on the terminal block with the removed screw - point (1).



Each time the cooktop is connected to the mains it carries out an automatic check which lasts several seconds.



WARNING! The power supply cable must be long enough to allow the hob to be removed from the worktop and must be positioned so as to avoid damage or overheating caused by contact with the base of the hob itself. Do not use extension leads.

Power supply voltage

Wires	Amount x size
230V ~ +	3 X 4 mm ² (3X2.5 mm ² Domino)
230-240V ~ +	3 X 4 mm ² (Australia only) (3X2.5 mm ² Domino)
230V 3 ~ +	4 X 1.5 mm ²
400V 3N ~ +	5 X 1.5 mm ²
400V 2N ~ +	4 x 1.5 mm ²



If the hob already has a power cable, follow the instructions given on the label attached to the cable. Connect the appliance to the electricity supply by means of an all-pole disconnect switch with minimum contact gap of 3 mm.

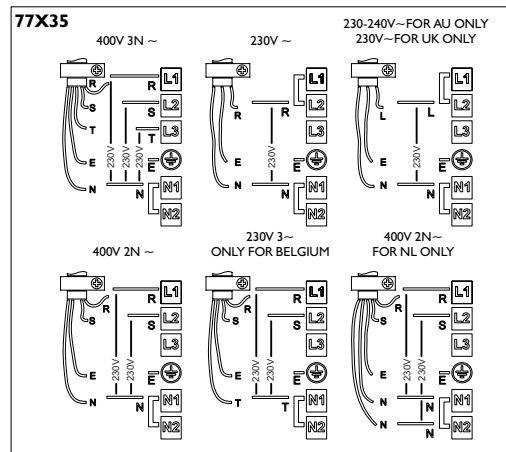
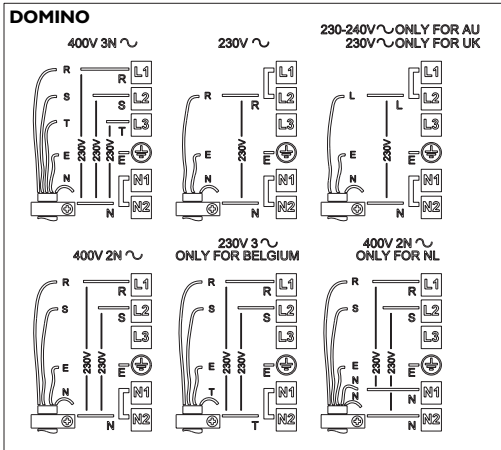
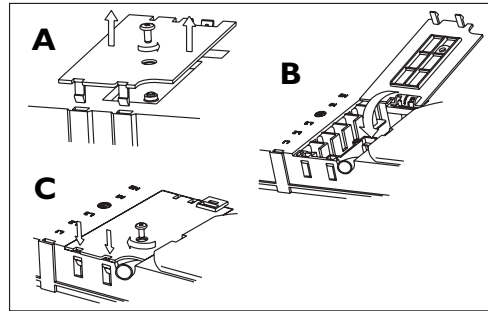

Installation and fixing



WARNING! The installer is responsible for any damage or injury resulting from incorrect installation.

To guarantee correct operation, the appliance must be installed on a perfectly flat surface.
For cut-out dimensions, see the figure below.

The worktop must be -20 50mm thick.
If necessary, cut the kitchen unit and worktop to fit before installing the hob. Clean the cutout of any chips that could compromise appliance operation.

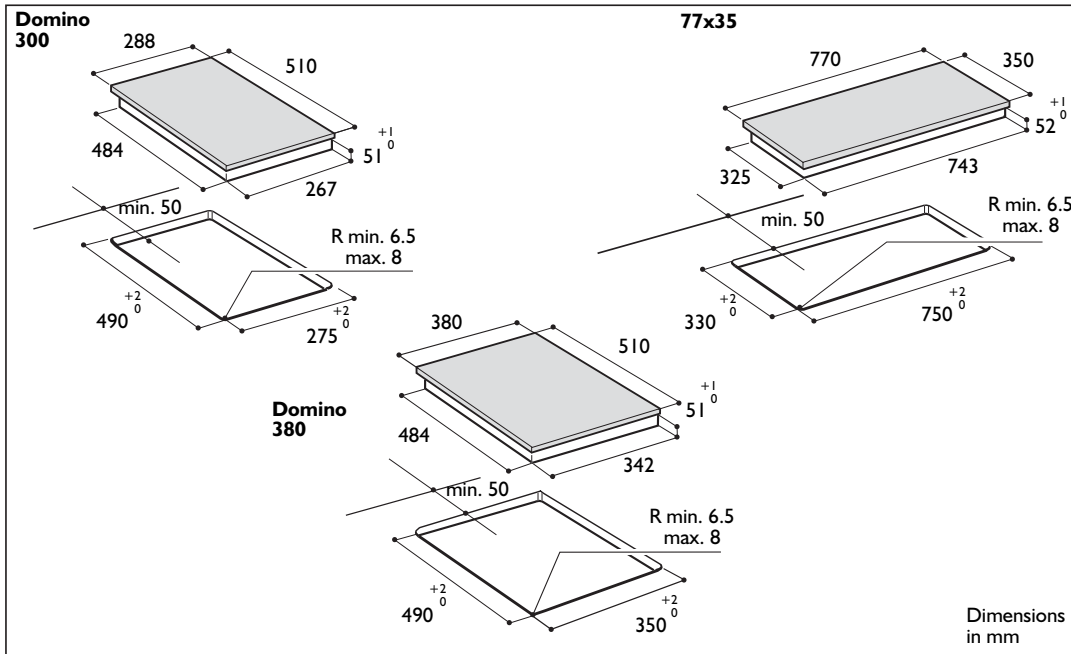

To guarantee correct operation, the appliance must be installed on a perfectly flat surface.
The worktop must be 20-50 mm thick.
If necessary, cut the kitchen unit and worktop to fit before installing the hob. Clean the cutout of any remaining dust that could compromise appliance operation.
For the distance between the underside of the induction hob and the kitchen unit (or separating panel), observe the dimensions given in the figure at the side. If a column unit is installed adjacent to the hob, leave a distance of at least 100 mm from the edge of the hob.

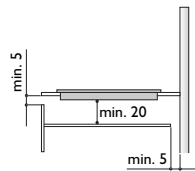

Assembly profit

1. Position the clips (A) in the spaces provided on the hob trim (fig. 3) if not already positioned.
2. Measure the centre point of the vertical sides of the cut-out (fig. 1).
3. Fit the brackets (C) in the centre of the vertical sides, aligning the upper edge of the brackets so that they are flush with the worktop surface (fig. 2).
4. Fix the brackets with the 4 screws supplied (B) using the holes provided.
5. Insert the hob in the cutout, making sure the clips (A) are secured in the spaces provided (fig. 4).

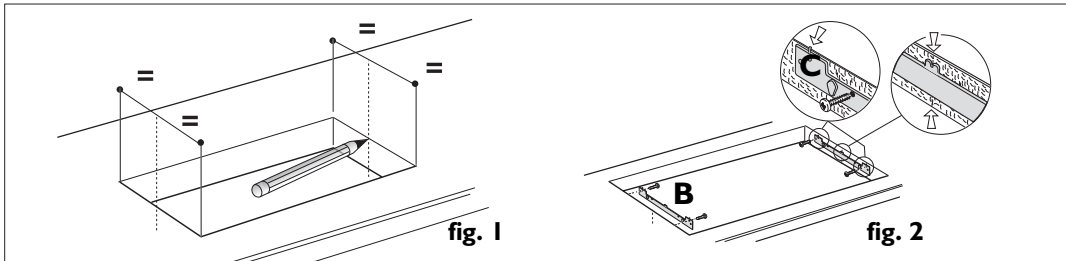

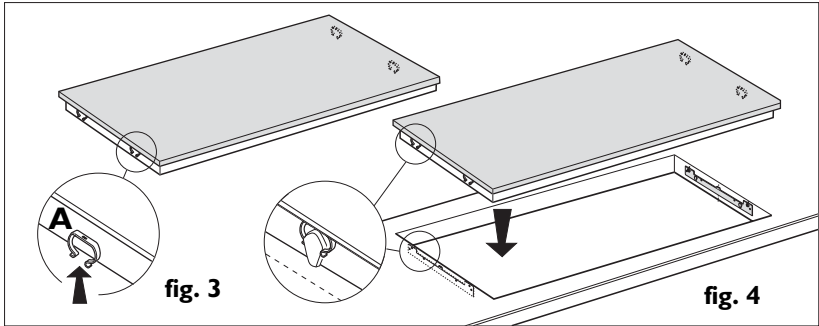

Undercounter oven installation:

- If an oven (which must be of our manufacture) is to be installed under the hob, ensure it is equipped with a cooling system and observe the distances given in the figure to the side.
- There must be nothing between the cooktop and the oven (cross rails, panels, brackets, etc.).

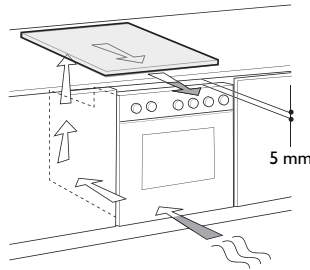

OPERATING INSTRUCTIONS

Control panel

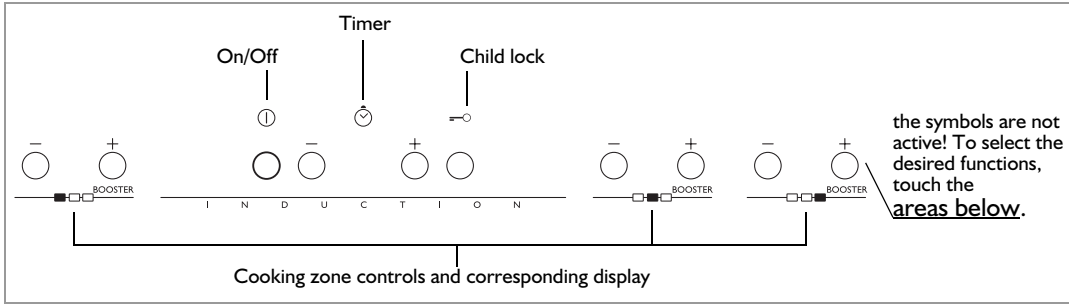

i Control panel graphics shown in these instructions might not match exactly the graphics of your hob. Button's functions are the same for all hob models.

Switching the hob ON/OFF

To switch the hob on, press the **⓪** button for approx. 2 seconds until the cooking zone displays light up. To switch off, press the same button until the displays switch off. All the cooking zones are switched off.

If the hob has been in use, the residual heat indicator "H" remains lit until the cooking zones have cooled down.

i The hob automatically switches off if no function is selected within 10 seconds of switching on.

Switching on and adjusting cooking zones

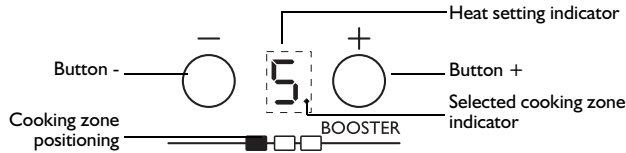

After switching on the hob and positioning the pot on the chosen cooking zone, adjust the heat setting using the button +. When switched on, the display shows level 5. Each cooking zone has different heat settings that can be adjusted using the buttons +/-, which go from "1": min. heat setting to "9": max. heat setting. Some cooking zones have a fast boil function (Booster), shown on the display with the letter "P".

Switching off cooking zones

Select the cooking zone to be switched off by pressing the "+" or "-" key (a dot lights up at the bottom right hand side of the heat setting indicator). Press the key "-" to set the level to "0". The cooking zone can also be switched off by pressing keys "+" and "-" at the same time. The cooking zone switches off and the residual heat indicator "H" lights up.

Child lock

This function locks the hob controls to prevent accidental switching on by children. To activate the child lock function, switch on the hob then press and hold the button  for three seconds: an acoustic signal and a luminous indicator under the key symbol signal activation. The control panel is locked with the exception of the OFF function. To unlock the controls, repeat the child lock activation procedure. The illuminated dot switches off and the hob is active again. The presence of cleaning water, liquid spilled from pots or any objects resting on the button below the symbol can accidentally activate or deactivate the child lock function.

Timer

The timer can be used to set a max. cooking time of 99 minutes (1 hour and 39 minutes) for one cooking zone only. Select the cooking zone to be used with the timer (an illuminated dot appears to the bottom right hand side of the heat setting indicator on the display), then set the desired cooking time using the buttons "+" and "-" of the timer function (see figure above). A few seconds after the button is pressed, the timer begins the countdown (the luminous dot of the selected cooking zone starts flashing). Once the set time has elapsed, an acoustic signal sounds and the cooking zone switches off automatically. To deactivate the timer, press the button "-" until the display shows "0:0" or press the buttons "+" and "-" of the timer at the same time.

Important! The timer function can only be used with one cooking zone at a time.

Fast boil function (Booster)

This function, only present on some cooking zones, makes it possible to exploit the hob's maximum power (for example to bring water to the boil very quickly). To select this function, press the button "+" until "P" appears on the display or, after switching the hob on, press the "-" button for the selected cooking zone. In this case too, "P" appears on the display. After 10 minutes' use of the booster function, the appliance automatically sets the zone to level 9.

Minute minder

The minute minder can only be used when the hob is not in use and allows a maximum setting of 99 min. Press the button "+" below the timer indicators: the display shows the minutes for setting. Select the time desired using the buttons + and -. After a few seconds the minute minder starts to count down. Once the set time has elapsed an acoustic signal sounds.

Important! The minute minder function can only be used when the hob is switched off; if it is then switched on, the minute minder countdown is automatically cancelled.

Control panel indicators.

Residual heat indicator.

The hob is fitted with a residual heat indicator for each cooking zone. These indicators alert the user when cooking zones are still hot.

If the display shows , the cooking zone is still hot. If the residual heat indicator of a given cooking zone is lit, that zone can be used, for example, to keep a dish warm or to melt butter. When the cooking zone cools down, the display switches off.

Incorrect or missing pot indicator.

The hob features an automatic pot detection system for all cooking zones. If no pot is detected, the display with the cooking zone power level indicator flashes. Make sure the pot is correctly positioned and that it has the characteristics given in the section "Before use".



MAINTENANCE

Care and maintenance

Clean the hob after each use in order to avoid damaging the surface and to prevent the formation of baked-on deposits which are difficult to remove. Before cleaning, make sure the cooking zones are switched off and that the residual heat indicator ("H") is not displayed.



- **DO NOT clean the hob with a steam cleaner!**
- **Periodically check for dust under the appliance, near the cooling air inlet or the outlet openings. This could hinder the ventilation and cooling of the electronic module and decrease the effectiveness of the hob.**

To clean the hob, proceed as follows:

1. use a soft clean cloth, absorbent kitchen wipes or a proprietary cleaner for glass ceramic hobs. Do not use abrasive sponges and/or metal scouring pads.
2. Food spills should be cleaned off before they bake onto the glass ceramic surface. Sugar and foods with a high sugar content damage the glass ceramic surface and must be immediately removed using a scraper for glass. Glass scrapers must be handled with care.
3. Remove any stubborn food residues with a scraper or proprietary detergents.
4. Salt, sugar and sand can scratch the glass ceramic hob: clean up any such spills on the hob immediately.

Troubleshooting Guide

- Before contacting After-sales Service:
- read and follow the instructions given in the section "Operating instructions".
- Connect the hob to the electricity supply and check that the

supply has not been shut off.

- Clean the hob and dry it thoroughly.
- If, when the hob is switched on, alphanumeric codes appear on the display, consult the following table for instructions.

ERROR CODE	DESCRIPTION	POSSIBLE CAUSES	REMEDY
The hob switches off and after 30 seconds emits an acoustic signal every 4 seconds	Continuous pressure on control panel area	Water or utensils on control panel	Clean the control panel
C81, C82	The control panel switches off because of excessively high temperatures	The internal temperature of electronic parts is too high	Wait for the hob to cool down before using it again
F42 or F43	The connection voltage is wrong	The sensor detects a discrepancy between the appliance voltage and that of the mains supply	Disconnect the hob from the mains and check the electrical connection
F12, F21, F25, F36, F37, F40, F47, F56, F58, F60	Call the After-Sales Service and specify the error code		



WARNING! If you are unable to turn the glass-ceramic hob off after using it, disconnect it immediately from the power supply.

After-sales Service

Before contacting After-sales Service:

- Try to solve the problem (see "Troubleshooting Guide").
- Switch the appliance off, wait 30 seconds then switch it on again. to see if the fault persists.

If after the above checks the fault persists, contact the nearest After-sales Service.

Always provide:

- a brief description of the fault;
- the exact type and model;
- the service number (number after the word Service on the rating plate. "See figure in the next page") is located on the underside of the cooktop or on the warranty booklet;
- your complete address and phone number.

If any repairs are required, please contact an authorized After-sales Service as indicated in the warranty.



WARNING! Failure to comply with these instructions may compromise the safety and quality of the product.

RATING PLATE**✓ USER ADVICE****Energy saving tips**

For optimum results, observe the following advice:

- Use pots and pans whose bottom diameter is equal to that of the cooking zone.
- Only use flat-bottomed pots and pans.
- If possible, keep pot lids on when cooking.
- Cook vegetables, potatoes, etc. with little water in order to cut down cooking time.
- Use a pressure cooker to save even more energy and time.
- Make sure you place the pot or pan in the centre of the cooking zone outlined on the hob.

Safeguarding the environment.**Packaging**

The packaging material is 100% recyclable and marked with the recycling symbol .

Electrical Appliances.

This appliance is marked in compliance with European Directive 2002/96/EC on Waste Electrical and Electronic Equipment (WEEE). By ensuring that this appliance is scrapped suitably, you can help prevent potentially damaging consequences for the environment and health.

- The symbol  on the appliance, or on documentation enclosed with the appliance, indicates that this product must not be treated as household waste, but must be delivered to the nearest collection centre for the recycling of electrical and electronic appliances. Disposal must be carried out in accordance with local environmental regulations for waste disposal. For further information on the treatment, recovery and recycling of this appliance, contact your competent local authority, the collection service for household waste.

Declaration of Conformity 

- This hob is suitable for contact with foodstuffs and complies with EEC (CE) regulation n. 1935/2004.
- The appliances are designed solely for use as cooking appliances. Any other use (e.g. for room heating) is considered as improper use and potentially dangerous.
- The appliances are designed, built and sold in compliance with:
 - safety objectives of the "Low Voltage" Directive 2006/95/CE (which replaces 73/23/CEE and subsequent amendments);
 - Protection requirements of EMC Directive 89/336/EEC "Electromagnetic compatibility";
 - the requirements of Directive 93/68/EEC.

IMPORTANT

Attach here one of the two appliance data plate stickers found in the warranty booklet