

KitchenAid

STAND MIXER

5KSM55, 5KSM60, 5KSM70

PRODUCT GUIDE



W11620767A

PARTS AND FEATURES

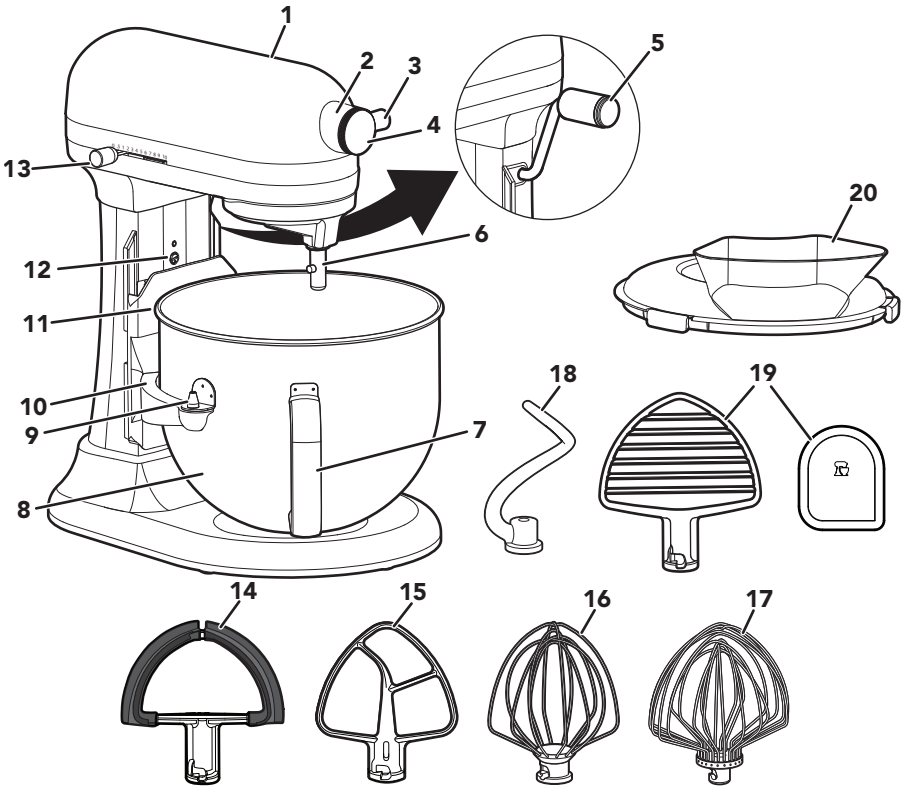

- | | |
|-------------------------------------------|-----------------------------------------------|
| 1. Motor Head | 12. Beater Height Adjustment Screw |
| 2. Attachment Hub | 13. Speed Control Lever |
| 3. Attachment Knob | 14. Double Flex Edge Beater** |
| 4. Hub Cover | 15. Flat Beater |
| 5. Bowl-Lift Lever | 16. 6-Wire Whip** |
| 6. Beater Shaft | 17. 11-Wire Stainless Steel Elliptical Whip** |
| 7. Bowl Handle* | 18. Spiral Dough Hook |
| 8. Bowl* | 19. Pastry Beater** and Scraper** *** |
| 9. Locating Pins | 20. Pouring Shield** |
| 10. Bowl Support | |
| 11. Spring Latch and Bowl Pin (Not Shown) | |

*Bowl type may vary. Bowls are also available for purchase as separate accessories.

**Available with select models only and available as an accessory purchase.

***Can also be used to scrape your Bowl.

PRODUCT SAFETY

Your safety and the safety of others are very important.

We have provided many important safety messages in this manual and on your appliance. Always read and obey all safety messages.



This is the safety alert symbol.

This symbol alerts you to potential hazards that can kill or hurt you and others.

All safety messages will follow the safety alert symbol and either the word "DANGER" or "WARNING." These words mean:

 **DANGER**

You can be killed or seriously injured if you don't immediately follow instructions.

 **WARNING**

You can be killed or seriously injured if you don't follow instructions.

All safety messages will tell you what the potential hazard is, tell you how to reduce the chance of injury, and tell you what can happen if the instructions are not followed.

IMPORTANT SAFEGUARDS

When using electrical appliances, basic safety precautions should always be followed, including the following:

1. Read all instructions. Misuse of appliance may result in personal injury.
2. To protect against the risk of electrical shock do not put Stand Mixer in water or other liquid.
3. This appliance is not intended for use by persons (including children) with reduced physical, sensory, or mental capabilities, or lack of experience and knowledge unless they are closely supervised and instructed concerning the use of the appliance by a person responsible for their safety.
4. European Union Only: This appliance shall not be used by children. Keep the appliance and its cord out of reach of children.

- 5.** European Union Only: Appliances can be used by persons with reduced physical, sensory or mental capabilities or lack of experience and knowledge if they have been given supervision or instruction concerning use of the appliance in a safe way and understand the hazards involved.
- 6.** Children should be supervised to ensure that they do not play with the appliance.
- 7.** If the supply cord is damaged, it must be replaced by KitchenAid, its service agent or similarly qualified persons in order to avoid a hazard.
- 8.** Turn the appliance off (0), then unplug from the outlet when not in use, before assembling or disassembling parts and before cleaning. To unplug, grasp the plug and pull from the outlet. Never pull from the power cord.
- 9.** Avoid contacting moving parts. Keep hands, hair, and clothing, as well as spatulas and other utensils, away from beater during operation to reduce the risk of injury to persons and/or damage to the Stand Mixer.
- 10.** Do not operate any appliance with a damaged cord or plug, or after the appliance malfunctions, or is dropped or damaged in any manner. Return appliance to the nearest Authorized Service Facility for examination, repair, or electrical or mechanical adjustment.
- 11.** The use of accessories/attachments not recommended or sold by KitchenAid may cause fire, electrical shock, or injury to persons.
- 12.** Never leave the appliance unattended while it is in operation.
- 13.** Do not use the appliance outdoors.
- 14.** Do not let the cord hang over the edge of table or counter.
- 15.** Remove the Flat Beater, Wire Whip, Pastry Beater, Double Flex Edge Beater or Spiral Dough Hook from the Stand Mixer before washing.
- 16.** To avoid product damage, do not use the Stand Mixer Bowls in areas of high heat such as an oven, microwave, or on a stovetop.
- 17.** Refer to the “Care and Cleaning” section for instructions on cleaning the surfaces in contact with food.
- 18.** Allow the appliance to cool completely before putting on or taking off parts, and before cleaning the appliance.

19. This appliance incorporates an earth connection for functional purposes only.
20. This appliance is intended to be used in household and similar applications such as:
- staff kitchen areas in shops, offices and other working environments;
 - farmhouses;
 - by clients in hotels, motels and other residential type environments;
 - bed and breakfast type environments.

SAVE THESE INSTRUCTIONS

For complete details on product information, instructions and videos, including Guarantee information, visit www.kitchenaid.co.uk/product-tips, www.kitchenaid.ie/product-tips, or www.KitchenAid.eu.

ELECTRICAL REQUIREMENTS

WARNING

Electrical Shock Hazard



Plug into an earthed outlet.

Do not remove earth prong.

Do not use an adapter.

Do not use an extension cord.

Failure to follow these instructions can result in death, fire, or electrical shock.

Voltage: 220-240 V

Frequency: 50-60 Hz

Power: 375 W

NOTE: The power rating for your Stand Mixer is printed on the trim brand or on the serial plate.

Do not use an extension cord. If the power supply cord is too short, have a qualified electrician or service technician install an outlet near the appliance.

SPEED CONTROL GUIDE

ACCESSORY	USE FOR	DESCRIPTION	SPEED
Flat Beater	Mixing and folding in ingredients	Folding delicate ingredients, egg whites, cream, and avoiding overmixing. Mixing cakes, frostings, cookies, etc.	1/2 speed for folding Speeds 1-6 for mixing
Double Flex Edge Beater**	Mixing ingredients	Mixing cakes, frostings, cookies, etc.	Speeds 1-6 for mixing
Spiral Dough Hook	Kneading	Breads, rolls, pizza dough, etc.	Speed 2 for kneading
6-Wire Whip**/ 11-Wire Stainless Steel Elliptical Whip**	Whipping	Eggs, egg whites, cream, etc.	Speeds 4-10 for whipping
Pastry Beater**	Cutting butter into flour, mashing fruits/vegetables, shredding meats	Pie dough and other pastries; mashed potatoes/fruits/vegetables, shredded chicken	Pastries (Cutting butter into flour): Speed 2 Mashing Fruits/ Vegetables: Up to Speed 2 Mashing Potatoes, Shredding Meat: Speed 4

NOTE: Use Speed 2 to mix or knead yeast doughs. Use of a higher speed creates high potential for Stand Mixer failure. The PowerKnead Spiral Dough Hook efficiently kneads most yeast dough within 4 minutes. The use of a lower speed might slow down the unit and not thoroughly knead the dough.

**Available with select models only and available as an accessory purchase.

PRODUCT ASSEMBLY

1. Turn the Stand Mixer off (0) and then Unplug.

To attach the Bowl*: Fit the Bowl Supports over Locating Pins and press down on back of the Bowl* until Bowl Pin snaps into Spring Latch.

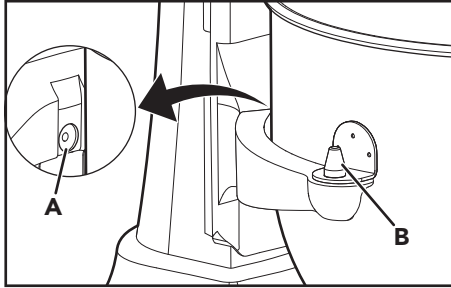

A. Spring Latch
B. Locating Pin

2. **To remove Bowl*:** Place Bowl-Lift Lever in the down position. Grasp Bowl Handle* and lift straight up and off Locating Pins.

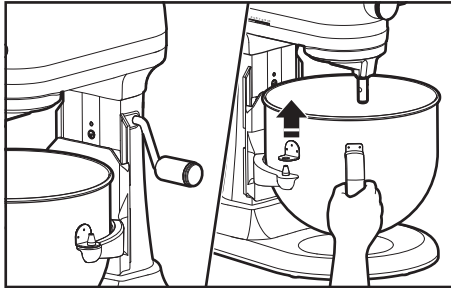

3. **To attach the accessory:** Slip the accessory onto the shaft. Turn to hook it over the Pin on the shaft.

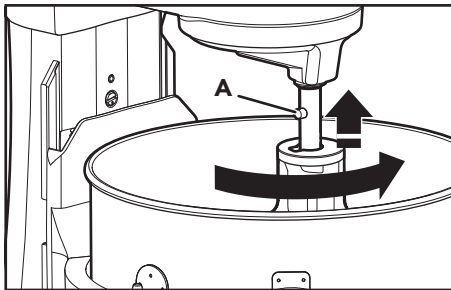

A. Pin

*Bowl type may vary. Bowls are also available for purchase as separate accessories.

4. **To remove the accessory:** Turn the Stand Mixer off (0) and then unplug. Press accessory upward and turn to the left. Pull down the accessory from Beater Shaft.

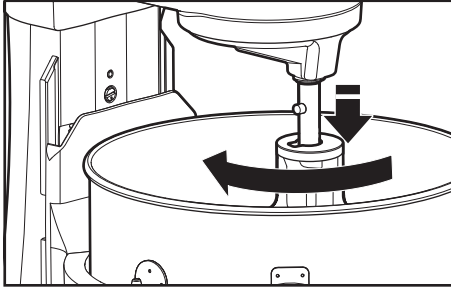

IMPORTANT: If the Bowl* is not securely snapped into place, it will be unstable and wobble during use.

5. **To raise the Bowl*:** Rotate the Bowl-Lift Lever to the straight up position. The Bowl* must always be in the raised position when mixing.

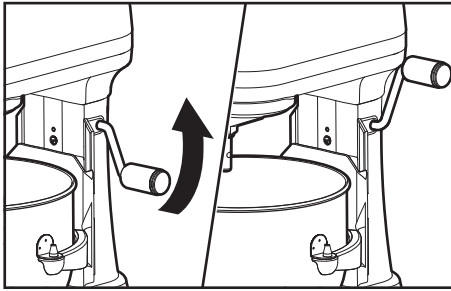

6. **Test the Beater to Bowl* Clearance:** Turn Stand Mixer ON and test each speed, making sure the beater does not touch the Bowl* during operation. If the Beater is too far away from the bottom or is hitting the Bowl*, proceed to next step to make adjustments.

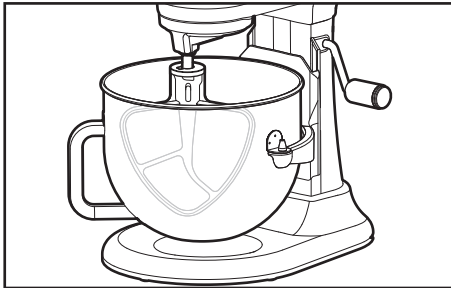

*Bowl type may vary. Bowls are also available for purchase as separate accessories.

7. **(OPTIONAL) To adjust Beater to Bowl* Clearance:** Lower the Bowl* to the down position. Turn the screw slightly counterclockwise (left) to raise the beater, or clockwise (right) to lower it. Adjust the beater so that it just clears the surface of the Bowl*. Check again the clearance of the Beater to the Bowl*.

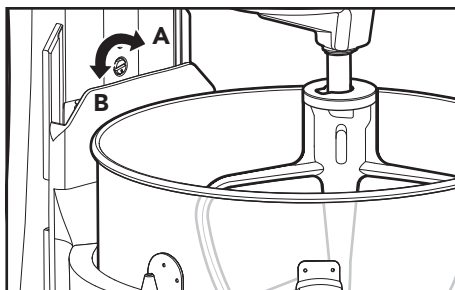

*A. Lower Bowl**

*B. Raise Bowl**

IMPORTANT: When properly adjusted, the Flat Beater will not strike on the bottom or sides of the Bowl*. If the Flat Beater or the Wire Whip** is so close that it strikes the bottom of the Bowl*, coating may wear off the beater or wires on the whip may wear.

*Bowl type may vary. Bowls are also available for purchase as separate accessories.

**Available with select models only and available as an accessory purchase.

PRODUCT USAGE

⚠ WARNING

Electrical Shock Hazard



Plug into an earthed outlet.

Do not remove earth prong.

Do not use an adapter.

Do not use an extension cord.

Failure to follow these instructions can result in death, fire, or electrical shock.

1. Plug the Stand Mixer into an earthed outlet. Start with lower speed to avoid splashing and increase it gradually. Refer to the “Speed Control Guide”.

⚠ WARNING

Injury Hazard

Unplug mixer before touching beaters.

Failure to do so can result in broken bones, cuts, or bruises.

2. Do not scrape the Bowl* while operating. Scraping the Bowl* once or twice during mixing is usually sufficient.

USING THE POURING SHIELD**

1. Turn the Stand Mixer off (0) and then unplug.
2. Attach Bowl* and Flat Beater, Dough Hook, or Wire Whip** to the mixer. Attach Bowl* and raise into locked position.
3. Place the shield onto the Bowl* so that the Motor Head covers the U-shaped gap in the shield. This will position the pouring chute just to the right of the Attachment Hub as you face the Mixer. Press lightly so that the tabs snap the shield onto the Bowl*.
4. Pour ingredients into the Bowl* through the Pouring Chute.

PRODUCT DISASSEMBLY

1. Turn the Stand Mixer off (0) and then unplug.
2. Lift the front of the Pouring Shield** clear of the rim of the Bowl*. Pull away from the Stand Mixer. Lower the Bowl* and scrape.

*Bowl type may vary. Bowls are also available for purchase as separate accessories.

**Available with select models only and available as an accessory purchase.

OPTIONAL ATTACHMENTS

KitchenAid offers a wide range of optional attachments such as the Spiralizer, Pasta Cutters, or Food Grinder that may be attached to the Stand Mixer attachment power hub.

1. Turn the Stand Mixer off (0) and then unplug. Unscrew Attachment Hub Cover. Insert attachment into Attachment Hub, making certain that attachment power shaft fits into the square Attachment Hub socket.

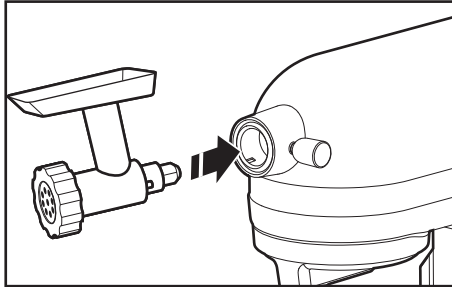

2. Tighten the Attachment Knob by turning it clockwise until the attachment is secured to the Stand Mixer.

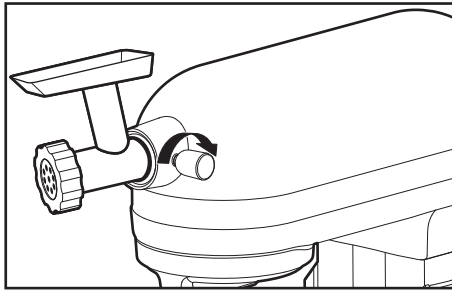

CARE AND CLEANING

IMPORTANT: Do not immerse the Stand Mixer Body in water or other liquids. Allow the appliance to cool completely before putting on or taking off parts, and before cleaning the appliance.

1. Turn the Stand Mixer off (0) and then unplug.
2. Wipe the Stand Mixer Body with a soft, damp cloth.
3. **The following parts are dishwasher-safe:** Bowl*.

The following parts are top rack dishwasher-safe: Flat Beater, Double Flex Edge Beater**, Spiral Dough Hook, 11-Wire Stainless Steel Elliptical Whip**, Pastry Beater**, Scraper***, and Pouring Shield**.

4. The following part should be hand-washed only, using warm, soapy water and drying thoroughly: 6-Wire Whip** only.

*Bowl type may vary. Bowls are also available for purchase as separate accessories.

**Available with select models only and available as an accessory purchase.

***Can also be used to scrape your Bowl.

TROUBLESHOOTING

WARNING

Electrical Shock Hazard



Plug into an earthed outlet.

Do not remove earth prong.

Do not use an adapter.

Do not use an extension cord.

Failure to follow these instructions can result in death, fire, or electrical shock.

PROBLEM	SOLUTION
If Stand Mixer warms up during use	Under heavy loads with extended mixing time periods, you may not be able to comfortably touch the top of the unit. This is normal.
If the Stand Mixer emit a pungent odour during initial use	This is normal. This is common with electric motors.
If the Flat Beater hits the Bowl*	Stop the Stand Mixer. See the “Product Assembly” section and adjust the Beater to Bowl* Clearance.
The Speed Control Lever does not move smoothly or easily	To move the Speed Control Lever with ease, lift slightly up as you move it across the settings in either direction.
If your Stand Mixer should fail to operate, please check the following	Is the Stand Mixer plugged in?
	Is the fuse in the circuit to the Stand Mixer in working order? If you have a circuit breaker box, be sure the circuit is closed.
	Turn off the Stand Mixer for 10-15 seconds, then turn it back on. If the Stand Mixer still does not start, allow it to cool for 30 minutes before turning it back on.
If product shuts off after extensive use	Motor has automatic sensor that will keep motor from overheating by shutting it off. If this occurs, turn speed switch to off (0) and let Stand Mixer rest for 30 minutes before restarting.
If mixer is slowing down or appearing to struggle	Are you using the appropriate beater and speed? See “Speed Control Guide” for more information. Using 1/2 Speed or Speed 1 for bread doughs and heavy loads might slow down the unit. Breads should knead with the Dough Hook at Speed 2. If you have slowdown with heavy loads at 1/2 Speed, increase to Speed 1 or 2.
If the problem cannot be corrected	See the “Terms of KitchenAid Guarantee (“Guarantee”)” section. Do not return the Stand Mixer to the retailer; retailers do not provide service.

*Bowl type may vary. Bowls are also available for purchase as separate accessories.

ELECTRICAL EQUIPMENT WASTE DISPOSAL

DISPOSAL OF PACKING MATERIAL

The packing material is recyclable and is marked with the recycle symbol ♻️. The various parts of the packing must therefore be disposed of responsibly and in full compliance with local authority regulations governing waste disposal.

RECYCLING THE PRODUCT

- This appliance is marked in compliance with law in the EU and UK covering, Waste Electrical and Electronic Equipment (WEEE).
- By ensuring this product is disposed of correctly, you will help prevent potential negative consequences for the environment and human health, which could otherwise be caused by inappropriate waste handling of this product.
- The symbol  on the product or on the accompanying documentation indicates that it should not be treated as domestic waste but must be taken to an appropriate collection centre for the recycling of electrical and electronic equipment.

For more detailed information about treatment, recovery and recycling of this product, please contact your local city office, your household waste disposal service or the shop where you purchased the product.

DECLARATION OF CONFORMITY

FOR UNITED KINGDOM

This appliance has been designed, constructed and distributed in compliance with the safety requirements of UK Legislation: Electrical Equipment (Safety) Regulations 2016, Electromagnetic Compatibility Regulations 2016. The Ecodesign for Energy-Related Products and Energy Information (Amendment) (EU Exit) Regulations 2019. The Restriction of the Use of Certain Hazardous Substances in Electrical and Electronic Equipment Regulations 2012.

FOR EUROPEAN UNION

This appliance has been designed, constructed, and distributed in compliance with the safety requirements of EC Directives: Low Voltage Directive 2014/35/EU, Electromagnetic Compatibility Directive 2014/30/EU, Ecodesign Directive 2009/125/EC, RoHS Directive 2011/65/EU and following amendments.

TERMS OF KITCHENAID GUARANTEE ("GUARANTEE")

Covering U.K. - Ireland - UAE

KitchenAid UK Limited Morley Way, Peterborough, Cambridgeshire PE2 9JB UK ("Guarantor") grants the end-customer, who is a consumer, a Guarantee pursuant to the following terms.

FOR U.K.:

The Guarantee applies in addition to and does not limit or affect the statutory warranty rights of the end-customer against the seller of the product. In summary, the Consumer Rights Act 2015 says products must be as described, fit for purpose and of satisfactory quality. During the expected lifespan of your product your legal rights entitle you to the following:

- Up to 30 days: if your product is faulty, then you can get an immediate refund.
- Up to six months: if your product can't be repaired or replaced, then you're entitled to a full refund, in most cases.
- Up to six years: if your product does not last a reasonable length of time you may be entitled to some money back.

These rights are subject to certain exceptions. For detailed information please visit the Citizens Advice website www.adviceguide.org.uk or call 03454 04 05 06.

FOR IRELAND:

The Guarantee applies in addition to and does not limit or affect the statutory warranty rights of the end-customer against the seller of the product under the European Communities (Certain Aspects of the Sale of Consumer Goods and Associated Guarantees Regulations 2003 (S.I. No. 11/2003)) and other enactments governing the sale of consumer goods.

FOR UAE:

The Guarantee applies in addition to and does not limit or affect the statutory warranty rights of the end-customer against the seller of the product.

1. SCOPE AND TERMS OF THE GUARANTEE

- a) The Guarantor grants the Guarantee for the products mentioned under Section 1.b) which a consumer has purchased from a seller or a company of the KitchenAid-Group within the following countries: U.K., Ireland, or the United Arab Emirates (UAE).
- b) The Guarantee period depends on the purchased product and is as follows:
- Two Year full guarantee from date of purchase: 5KSM55SXX, 5KSM70JPX.**
- Five Year full guarantee from date of purchase: 5KSM60SPX, 5KSM70SHX.**
- c) The Guarantee period commences on the date of purchase, i.e. the date on which a consumer purchased the product from a dealer or a company of the KitchenAid-Group.
- d) The Guarantee covers the defect-free nature of the product.
- e) The Guarantor shall provide the consumer with the following services under this Guarantee, at the choice of the Guarantor, if a defect occurs during the Guarantee period:
- Repair of the defective product or product part, or
 - Replacement of the defective product or product part. If a product is no longer available, the Guarantor is entitled to exchange the product for a product of equal or higher value.
- f) If the consumer wishes to make a claim under the Guarantee, the consumer has to contact the country specific KitchenAid service centres or the Guarantor directly at KitchenAid UK Limited Morley Way, Peterborough, Cambridgeshire PE2 9JB UK; Email-Address U.K.: CONSUMERCARE.UK@kitchenaid.eu
Email-Address IRELAND: CONSUMERCARE.IE@kitchenaid.eu
Toll Free Number U.K. & IRELAND: **00 800 381 040 26**

FOR UAE:

AL GHANDI ELECTRONICS.

POST BOX NO. 9098,

DUBAI, UNITED ARAB EMIRATES

Toll free number: +971 4 2570007

- g) The costs of repair, including spare parts, and any postage costs (if applicable) for the delivery of a defect-free product or product part shall be borne by the Guarantor. The Guarantor shall also bear the postage costs for returning the defective product or product part if the Guarantor or the country specific KitchenAid customer service centre requested the return of the defective product or product part. However, the consumer shall bear the costs of appropriate packaging for the return of the defective product or product part.
- h) To be able to make a claim under the Guarantee, the consumer must present the receipt or invoice of the purchase of the product.

2. LIMITATIONS OF THE GUARANTEE

- a) The Guarantee applies only to products used for private purposes and not for professional or commercial purposes.
- b) The Guarantee does not apply in the case of normal wear and tear, improper or abusive use, failure to follow the instructions for use, use of the product at the wrong electrical voltage, installation and operation in violation of the applicable electrical regulations, and use of force (e.g. blows).
- c) The Guarantee does not apply if the product has been modified or converted, e.g. conversions from 120 V products to 220-240 V products.
- d) The provision of Guarantee services does not extend the Guarantee period, nor does it initiate the commencement of a new Guarantee period. The Guarantee period for installed spare parts ends with the Guarantee period for the entire product.
- e) **FOR UAE ONLY:**

Further or other claims, in particular claims for damages, are excluded unless liability is mandatory by law.

After expiry of the Guarantee period or for products for which the Guarantee does not apply, the KitchenAid customer service centres are still available to the end-customer for questions and information.

Further information is also available on our website:

■ For U.K. & Ireland www.kitchenaid.eu

■ For UAE: www.KitchenAid-MEA.com

PRODUCT REGISTRATION

Register your new KitchenAid appliance now: www.kitchenaid.eu/register