

KURZANLEITUNG



DANKE, DASS SIE SICH FÜR EIN INDESIT-PRODUKT ENTSCHEIDEN HABEN
Für eine umfassende Hilfe und Unterstützung, registrieren Sie bitte Ihr Gerät unter www.indesit.com/register



Die Sicherheitshinweise und Gebrauchsanleitung können auf unserer Internetseite docs.indesit.eu heruntergeladen werden, bitte die Anweisungen auf der Rückseite des Heftes befolgen.



Lesen Sie vor Inbetriebnahme des Geräts sorgfältig die Sicherheitshinweise.

PRODUKTBESCHREIBUNG

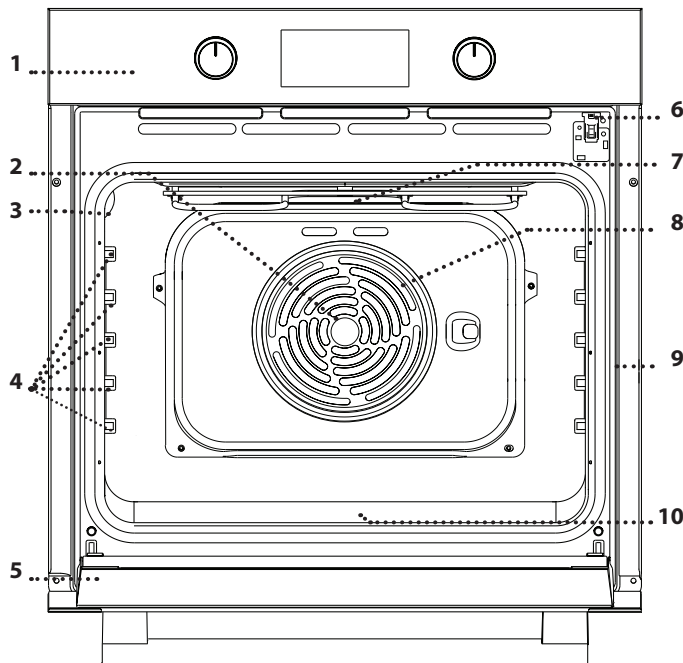

1. Bedienfeld
2. Gebläse
3. Lampe
4. Seitengitter
(die Einschubebene wird auf der Wand des Garraums angezeigt)
5. Tür
6. Türverriegelung
(verriegelt die Tür während die automatische Reinigung läuft und danach)
7. Oberes Heizelement/Grill
8. Ringheizelement
(nicht sichtbar)
9. Typenschild
(nicht entfernen)
10. Bodenheizelement
(nicht sichtbar)

BEDIENTAFEL

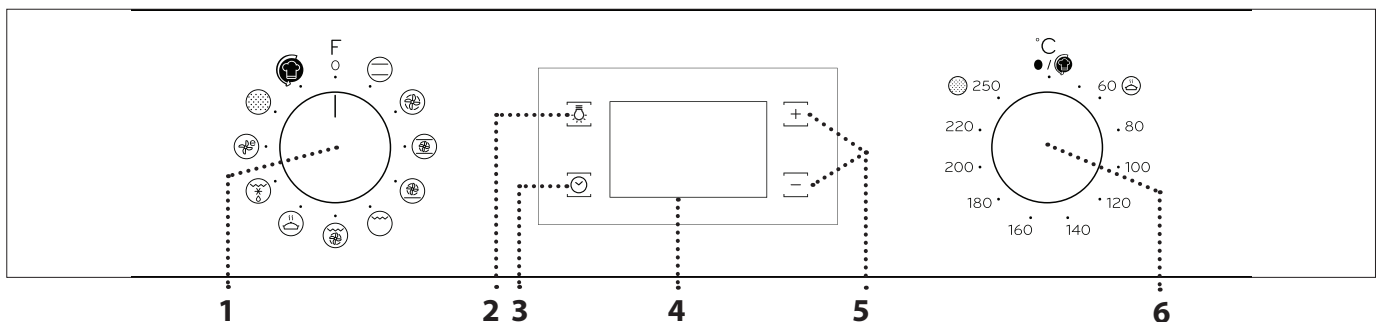

1. AUSWAHLKNOPF

Zum Einschalten des Ofens durch Funktionsauswahl.
Auf 0 drehen, um den Ofen auszuschalten.

2. LAMPEN

Bei eingeschaltetem Ofen drücken, um die Lampe im Garraum ein- oder auszuschalten.

3. EINSTELLUNG DER UHRZEIT

Für den Zugang zu Garzeiteinstellungen, Startverzögerung und Timer.
Zur Anzeige der Zeit, wenn der Ofen ausgeschaltet ist.

4. DISPLAY

5. EINSTELLTASTEN

Zum Ändern der Garzeiteinstellungen.

6. THERMOSTATREGLER

Drehen, um die gewünschte Temperatur bei Aktivierung der manuellen Funktionen auszuwählen. Für die „Turn & Go“ Funktion auf halten.

ROST

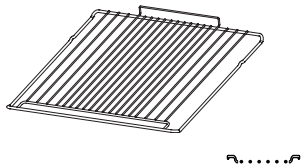

FETTPFANNE (WENN VORHANDEN)

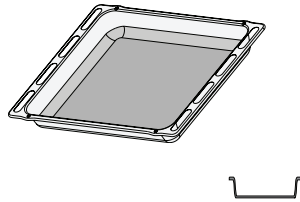

BACKBLECH

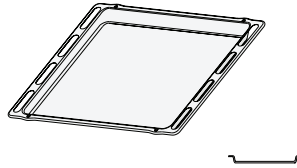

SCHIEBEROSTE (falls vorhanden)

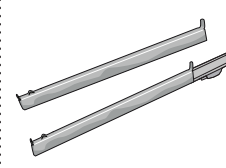

Die Anzahl und Art der Zubehörteile kann je nach gekauftem Modell variieren. Weitere Zubehörteile sind separat über den Kundenservice erhältlich.

BENUTZUNG DER ZUBEHÖRTEILE

• Den Rost auf die gewünschte Ebene einschieben, ihn dabei leicht nach oben gekippt halten und die angehobene hintere Seite (nach oben zeigend) zuerst nach unten legen. Dann horizontal entlang des Seitengitters so weit wie möglich schieben. Die anderen Zubehörteile, wie das Backblech, werden horizontal eingesetzt, indem sie entlang der Seitengitter eingeschoben werden.

- Die Seitengitter können zum Reinigen des Ofens vollständig ausgehängt werden : ziehen, um das Seitengitter aus seinem Sitz zu entfernen.
- Die Auszugschienen können auf einer beliebigen Einschubebene entfernt oder angebracht werden.

FUNKTIONEN



OBER/UNTERHITZE

Zum Garen aller Arten von Gerichten auf nur einer Einschubebene.



MEHRERE EINSCHUBEbenen

Zum Garen verschiedener Speisen, welche die gleiche Gartemperatur auf verschiedenen Einschubebenen (maximal drei) zur gleichen Zeit benötigen. Die Funktion erlaubt das Garen ohne Geschmacksübertragung von einer Speise auf die anderen.



XL COOKING

Zum Garen von großen Fleischstücken (über 2,5 kg). Es wird empfohlen, das Fleisch während dem Garvorgang zu wenden, um sicherzustellen, dass beide Seiten gleichmäßig gebräunt werden. Es wird außerdem empfohlen, das Fleischstück gelegentlich zu begießen, um ein übermäßiges Austrocknen zu vermeiden.



PIZZA

Zum Backen verschiedener Sorten und Formen von Brot und Pizza. Es wird empfohlen, die Position des Backblechs nach der Hälfte der Garzeit zu wechseln.



GRILL

Zum Grillen von Steaks, Grillspießen und Bratwürsten, zum Überbacken von Gemüse oder Rösten von Brot. Beim Grillen von Fleisch wird die Verwendung eines Backblechs zum Aufsammeln der Garflüssigkeiten empfohlen: Die Fettpfanne unter eine beliebige Einschubebene unter den Rost stellen und 200 ml Trinkwasser zufügen.



GRATIN

Zum Garen großer Fleischstücke (Keulen, Roastbeef, Hähnchen). Es wird die Verwendung eines Backblechs zum Aufsammeln der Garflüssigkeiten empfohlen: Die Fettpfanne unter eine beliebige Einschubebene unter den Rost stellen und 200 ml Trinkwasser zufügen.



WARMHALTEN

Für ein effektives Gären von süßen und salzigen Teigen. Damit die Qualität beim Gehen lassen gesichert ist, die Funktion keinesfalls aktivieren, wenn der Backofen nach einem Garzyklus noch heiß ist.



FREASY COOK

Alle Heizelemente und der Lüfter schalten sich ein und garantieren eine dauerhafte und gleichmäßige Wärmeverteilung im Ofen. Beim Programm Freasy Cook ist kein Vorheizen des Backofens nötig. Es eignet sich besonders zum schnellen Garen von Fertiggerichten (tiefgekühlt oder nicht). Die besten Ergebnisse erhalten Sie, wenn Sie nur einen Rost verwenden.



ECO MEHRERE EINSCHUBEbenen

Zum Garen von Braten und gefüllten Bratenstücken auf einer Einschubebene. Durch eine sanfte, zeitweilige Luftzirkulation wird ein übermäßiges Austrocknen der Speise vermieden. Bei der Verwendung dieser ECO-Funktion bleibt die Beleuchtung während des Garvorgangs ausgeschaltet, aber sie kann durch Drücken der Taste wieder eingeschaltet werden.



AUTOMATISCHER PYROLYSE-REINIGUNGSZYKLUS

Hierbei werden bei den Garvorgängen entstandene Spritzer in einem extrem hohen Temperaturzyklus (etwa 400 °C) verbrannt.



TURN & GO







Diese Funktion wählt automatisch die ideale Temperatur und Zeit zum Backen zahlreicher Rezepte aus, darunter Fleisch, Fisch, Nudeln, Desserts und Gemüse. Aktivieren Sie die Funktion, wenn der Backofen kalt ist.

ERSTE INBETRIEBNAHME DES GERÄTS

1. EINSTELLUNG DER UHRZEIT

Wenn den Ofen zum ersten Mal eingeschaltet wird, muss die Zeit eingestellt werden:  drücken, bis das Symbol  erscheint und die beiden Ziffern für die Stunden auf dem Display zu blinken beginnen.



Mit  oder  die Stunde einstellen und  zur Bestätigung drücken. Die beiden Ziffern für die Minuten beginnen zu blinken. Mit  oder  die Minuten einstellen und  zur Bestätigung drücken.



Bitte beachten: Wenn das Symbol  blinkt, zum Beispiel nach längerem Stromausfall, müssen Sie die Zeit zurückstellen.

2. EINSTELLEN DES STROMVERBRAUCHS

Der Ofen ist für den Betrieb mit einer Leistung von weniger als 2,9 kW („Lo“) programmiert: Um den Ofen bei einer Leistung zu betreiben, die mit einer Haushaltsstromversorgung von mehr als 3 kW („Hi“) kompatibel ist, müssen Sie die Einstellungen ändern. Um zum Änderungs Menü zu gehen, den *Auswahlknopf* auf  drehen, dann zurück auf 0 drehen.

Halten Sie unmittelbar danach  und  fünf Sekunden lang gedrückt.



Verwenden Sie  oder , um die Einstellung zu ändern. Halten Sie dann  mindestens zwei Sekunden gedrückt, um zu bestätigen.

3. AUFHEIZEN DES OFENS

Ein neuer Ofen kann Gerüche freisetzen, die bei der Herstellung zurückgeblieben sind: Das ist ganz normal.

Vor dem Garen von Speisen wird daher empfohlen, den Ofen in leerem Zustand aufzuheizen, um mögliche Gerüche zu entfernen.

Schutzkarton und Klarsichtfolie aus dem Ofen entfernen und die Zubehörteile entnehmen.

Den Ofen für ungefähr eine Stunde auf 250 °C bevorzugt mit der „XL Cooking“-Funktion aufheizen. Der Ofen muss während dieser Zeit leer sein. Die Anweisungen zur korrekten Einstellung der Funktion befolgen.

Bitte beachten: Es ist empfehlenswert, den Raum nach dem ersten Gebrauch des Geräts zu lüften.

TÄGLICHER GEBRAUCH

1. AUSWÄHLEN EINER FUNKTION

Um eine Funktion auszuwählen, den *Auswahlknopf* auf das Symbol für die gewünschte Funktion drehen: die Anzeige leuchtet auf und ein Signalton ertönt.



2. EINE FUNKTION AKTIVIEREN

MANUELL

Um die Funktion zu aktivieren, müssen Sie den *Thermostatregler* auf die gewünschte Temperatur drehen.



Bitte beachten: Während dem Garen können Sie die Funktion ändern, indem Sie den *Auswahlknopf* drehen oder die Temperatur durch Drehen des *Thermostatreglers* anpassen. Die Funktion startet nicht, wenn der *Thermostatregler* auf  steht.

Sie können die Garzeit, das Garzeitende (nur wenn eine Garzeit ausgewählt wurde) und einen Timer einstellen.

TURN & GO

Um die „Turn & Go“-Funktion zu aktivieren, den *Auswahlknopf* auf das entsprechende Symbol drehen und

den *Thermostatregler* auf dem Symbol  lassen. Zum Beenden des Garvorgangs, den *Auswahlknopf* anschalten „0“.

Bitte beachten: Um beste Garergebnisse mit der „Turn & Go“-Funktion zu erhalten, verwenden Sie die empfohlenen Gewichte für jede Speise, wie in der folgenden Tabelle angegeben.

Lebensmittel	Rezept	Gewicht (kg)
Fleisch	Kalbsbraten, Roastbeef englisch	0,6 - 0,7
	Hähnchen / Lammkeule in Stücken	1,0 - 1,2
Fisch	Lachsfilet / gebackener Fisch (ganz)	0,9 - 1,0
	Fisch in Folie gebacken	0,8 - 1,0
Gemüse	Gefülltes Gemüse	1,8 - 2,5
	Gemüsetorte	1,5 - 2,5
Salzige Kuchen	Quiche Lorraine / Pudding	1,0 - 1,5
Nudelgerichte	Lasagne / Pastete aus Nudeln oder Reis	1,5 - 2,0
Backwaren/ Torten	Hefekuchen / Marmorkuchen	0,9 - 1,2
	Backäpfel	1,0 - 1,5
Brot	Brotlaib	0,5 - 0,6
	Gebäckstangen	0,5 - 0,8

3. VORHEIZEN

Sobald die Funktion aktiviert ist, geben ein Signalton und ein blinkendes Symbol  auf der Anzeige an, dass das Vorheizen aktiviert wurde.



Nach dieser Phase, ertönt ein akustisches Signal und das feststehende Symbol  auf dem Display zeigen an, dass der Backofen die eingestellte Temperatur erreicht hat: An diesem Punkt die Speise in den Ofen stellen und den Garvorgang fortsetzen.

Bitte beachten: Wird die Speise in den Ofen gestellt, bevor das Vorheizen beendet ist, kann dies negative Auswirkungen auf das endgültige Garergebnis haben.



. PROGRAMMIERTES GAREN

Vor dem Start des programmierten Garen müssen Sie eine Funktion auswählen.

DAUER



 solange drücken, bis das Symbol  und „00:00“ auf der Anzeige blinkt.





 oder  zum Einstellen der gewünschten Garzeit verwenden, anschließend  zur Bestätigung drücken. Die Funktion durch Drehen des *Thermostatreglers* auf die gewünschte Temperatur aktivieren: Es ertönt ein akustisches Signal und das Display zeigt an, dass der Garvorgang beendet ist.

Hinweise: Um die eingestellte Garzeit zu ändern,  gedrückt halten, bis das Symbol  auf der Anzeige blinkt, dann mit  die Garzeit auf „00:00“ zurückstellen. Diese Garzeit enthält eine Vorheizphase.

PROGRAMMIERUNG DES GARZEITENDES/ STARTVERZÖGERUNG

Nachdem die Garzeit eingestellt wurde, kann die Aktivierung der Funktion durch die Programmierung der Abschaltzeit verzögert werden:  drücken, bis das Symbol  und die aktuelle Zeit auf der Anzeige blinken.



oder  verwenden  zum Einstellen der Abschaltzeit und  zur Bestätigung drücken. Die Funktion durch Drehen des *Thermostatreglers* auf die gewünschte Temperatur aktivieren: Die Funktion ist angehalten, bis sie automatisch nach der berechneten Zeit startet, damit der Garvorgang zur eingestellten Zeit endet.

Hinweise: Um die Einstellung abubrechen, den *Auswahlknopf* auf **0** drehen, um den Ofen auszuschalten.

Hinweise: Die Startvorwahl zum Starten der Funktion ist für Grill- und Turbo Grill-Funktionen nicht verfügbar.

ENDE DES GARVORGANGS

Es ertönt ein akustisches Signal und das Display zeigt an, dass die Funktion beendet ist.





Den *Auswahlknopf* drehen, um eine andere Funktion auszuwählen, oder auf „0“ drehen, um den Ofen auszuschalten.

Bitte beachten: Wenn der Timer aktiviert ist, zeigt die Anzeige abwechseln „ENDE“ und die verbleibende Zeit an.



. TIMER EINSTELLEN

Diese Option unterbricht oder programmiert nicht das Garen, aber ermöglicht es Ihnen die Anzeige als Timer zu verwenden, sowohl wenn eine Funktion aktiviert ist als auch bei ausgeschaltetem Ofen.

 solange drücken, bis das  und das Symbol „00:00“ und „00:00“ auf der Anzeige blinken.



 oder  zum Einstellen der gewünschten Zeit verwenden und  zur Bestätigung drücken. Es ertönt ein akustisches Signal, sobald der Timer das Rückzählen der ausgewählten Zeit beendet hat.

Hinweise: Um den Timer abubrechen,  gedrückt halten, bis das Symbol  zu blinken beginnt, dann mit  die Zeit auf „00:00“ zurückstellen.

. AUTOMATISCHE REINIGUNGSFUNKTION – PYROLYSE

Den Backofen während des Pyrolysezyklus nicht berühren.

Kinder und Tiere während und nach dem Pyrolysezyklus (bis die Belüftung des Raums abgeschlossen ist) vom Ofen entfernt halten.

Vor dem Ausführen der Pyrolysefunktion alle Zubehöreile - einschließlich der Seitengitter - aus dem Ofen entfernen. Falls der Backofen unter einer Kochfläche installiert ist, darauf achten, dass während der Selbstreinigung alle Gasflammen oder elektrischen Kochplatten ausgeschaltet sind.

Für optimale Reinigungsergebnisse, hartnäckige Verschmutzungen vor der Verwendung der Pyrolysefunktion mit einem feuchten Schwamm entfernen. Wir empfehlen, die Pyrolysefunktion nur bei starker Verschmutzung des Ofens durchzuführen oder wenn dieser während des Garvorgangs schlechte Gerüche freisetzt.

Zum Aktivieren der automatischen Reinigungsfunktion drehen Sie den *Auswahlknopf* und den *Thermostatregler* auf das Symbol . Die Funktion wird automatisch aktiviert, die Tür verriegelt und das Licht im Garraum ausgeschaltet: Das Display zeigt die verbleibende Zeit bis zum Ende im Wechsel mit „Pyro“.

Wenn das Programm fertig ist, bleibt die Tür gesperrt, bis die Temperatur im Gerät auf ein sicheres Niveau gesunken ist. Den Raum während und nach dem Pyrolysezyklus lüften.

GARTABELLE

REZEPT	FUNKTION	VORHEIZEN	TEMPERATUR (°C)	DAUER (MIN)	EINSCHUBEBENE UND ZUBEHÖRTEILE
Hefekuchen		Ja	160 - 180	30 - 90	2/3
		Ja	160 - 180	30 - 90	4 1
Gefüllter Kuchen Käsekuchen (Käsekuchen, Strudel, Apfelkuchen)		Ja	160 - 200	35 - 90	2
		Ja	160 - 200	40 - 90	4 2
Plätzchen (Kekse), Törtchen		Ja	160 - 180	20 - 45	3
		Ja	150 - 170	20 - 45	4 2
		Ja	150 - 170	20 - 45	5 3 1
Beignets		Ja	180 - 210	30 - 40	3
		Ja	180 - 200	35 - 45	4 2
		Ja	180 - 200	35 - 45	5 3 1
Baiser		Ja	90	150 - 200	3
		Ja	90	140 - 200	4 2
		Ja	90	140 - 200	5 3 1
Pizza/Brot		Ja	190 - 250	15 - 50	1 / 2
		Ja	190 - 250	20 - 50	4 2
Tiefkühlpizza		Ja	250	10 - 20	3
		Ja	230 - 250	10 - 25	4 2
Herzhafte Kuchen (Gemüsetorte, Quiche Lorraine)		Ja	180 - 200	40 - 55	3
		Ja	180 - 200	45 - 60	4 2
		Ja	180 - 200	45 - 60	5 3 1
Blätterteigtörtchen/salziges Blätterteiggebäck		-	190 - 200	20 - 30	3
		-	180 - 190	20 - 40	4 2
		-	180 - 190	20 - 40	5 3 1
Lasagne/überbackene Pasta/ Cannelloni /Aufläufe		Ja	190 - 200	45 - 65	2

FUNKTIONEN							
	Ober-/Unterhitze	Grill	Gratin	Pizza	Mehrere Einschubebenen	XL Cooking	ECO mehrere Einschubebenen

ZUBEHÖRTEILE					
	Rost	Backform oder Kuchenform auf Rost	Backblech/Fettpfanne oder Backform oder Kuchenform auf Rost	Fettpfanne / Backblech	Fettpfanne / Backblech mit 200 ml Wasser

REZEPT	FUNKTION	VORHEIZEN	TEMPERATUR (°C)	DAUER (MIN)	EINSCHUBEBENE UND ZUBEHÖRTEILE
Lamm/Kalb/ Rind/Schwein 1 kg		Ja	190 - 200	80 - 110	3
Schweinebraten mit Kruste 2 kg		Ja	180 - 190	110 - 150	2
Hähnchen/Kaninchen/Ente 1 kg		Ja	200 - 230	50 - 100	2
Puter/Gans 3 kg		-	190 - 200	100 - 160	2
Fisch gebacken/in Folie (Filets, ganz)		Ja	170 - 190	30 - 50	2
Gefülltes Gemüse (Tomaten, Zucchini, Auberginen)		Ja	180 - 200	50 - 70	2
Getoastetes Brot		-	250	2 - 6	5
Fischfilets/Scheiben		-	230 - 250	20 - 30*	4 3
Wurstchen, Fleischspieße, Rippchen, Hamburger		-	250	15 - 30*	5 4
Brathähnchen 1-1,3 kg		Ja	200 - 220	55 - 70**	2 1
Roastbeef englisch 1 kg		Ja	200 - 210	35 - 50**	3
Lammkeule, Haxe		Ja	200 - 210	60 - 90**	3
Bratkartoffeln		Ja	200 - 210	35 - 55**	3
Gemüsegratin		-	200 - 210	25 - 55	3
Fleisch und Kartoffeln		Ja	190 - 200	45 - 100***	4 1
Fisch und Gemüse		Ja	180	30 - 50***	4 1
Lasagne und Fleisch		Ja	200	50 - 100***	4 1
Komplette Mahlzeit: Obsttorte (Einschubebene 5)/Lasagne (Einschubebene 3)/Fleisch (Einschubebene 1)		Ja	180 - 190	40 - 120***	5 3 1
Braten/gefüllte Bratenstücke		-	170 - 180	100 - 150	2

Die angegebene Zeit beinhaltet keine Vorheizphase: es wird empfohlen die Speise erst in den Ofen zu geben und die Garzeit einzustellen, wenn die erforderliche Temperatur erreicht wurde.

* Das Gargut nach halber Garzeit wenden.

**Das Gargut nach zwei Dritteln der Garzeit wenden (bei Bedarf).

***Voraussichtliche Zeitdauer: Je nach persönlichen Vorlieben können die Speisen zu verschiedenen Zeitpunkten aus dem Ofen genommen werden.

Die Gebrauchsanleitung mit der Tabelle der erprobten Rezepte, die für die Zertifizierungsstellen in Übereinstimmung mit der IEC-Norm 60350-1 zusammengestellt wurden, auf docs.indesit.eu runterladen.

FUNKTIONEN							
	Ober-/Unterhitze	Grill	Gratin	Pizza	Mehrere Einschubebenen	XL Cooking	ECO mehrere Einschubebenen
ZUBEHÖRTEILE							
	Rost	Backform oder Kuchenform auf Rost	Backblech/Fettpfanne oder Backform oder Kuchenform auf Rost	Fettpfanne / Backblech	Fettpfanne / Backblech mit 200 ml Wasser		

WARTUNG UND REINIGUNG



Für weitere Informationen die Gebrauchsanleitung auf docs.indesit.eu runterladen

**Verwenden Sie keinen
Dampfreiniger.**

**Bei allen Vorgängen
Schutzhandschuhe tragen.**

**Die gewünschten Vorgänge bei
kaltem Ofen durchführen.**

**Trennen Sie das Gerät von der
Stromversorgung.**

**Keine Stahlwolle, Scheuermittel
oder aggressive/ätzende
Reinigungsmittel verwenden,
da diese die Flächen des Gerätes
beschädigen können.**

AUSSENFLÄCHEN

Reinigen Sie die Flächen mit einem feuchten Mikrofaser-
tuch. Sollten sie stark verschmutzt sein, einige Tropfen von
pH-neutralem Reinigungsmittel verwenden. Reiben Sie mit
einem trockenen Tuch nach.

Keine aggressiven Reinigungs- oder Scheuermittel verwen-
den. Falls ein solches Mittel versehentlich mit den Flächen
des Gerätes in Kontakt kommt, dieses sofort mit einem
feuchten Mikrofaser-tuch reinigen.

INNENFLÄCHEN

• Den Ofen nach jedem Gebrauch abkühlen lassen und an-
schließend reinigen, vorzugsweise wenn dieser noch warm
ist, um durch Speiserückstände verursachte Ablagerungen
oder Flecken zu entfernen. Zum Trocknen von Kondensa-
tion, die sich beim Garen von Speisen mit einem hohen

Wassergehalt bildet, den Ofen vollständig abkühlen lassen
und anschließend mit einem Tuch oder Schwamm trocken-
wischen.

- Bei hartnäckigen Verschmutzungen auf den Innenflächen
empfehlen wir für optimale Reinigungsergebnisse die Aus-
führung der automatischen Reinigungsfunktion.
- Die Tür kann einfach entfernt und wieder angebracht wer-
den für eine einfache Reinigung des Glas .
- Das Glas der Backofentür mit einem geeigneten Flüssigrei-
niger reinigen.

ZUBEHÖRTEILE

Die Zubehörteile nach dem Gebrauch in Geschirrspülmit-
tellaug einweichen, Backofenhandschuhe verwenden,
solange die Zubehörteile noch heiß sind. Speiserückstände
können dann mit einer Spülbürste oder einem Schwamm
entfernt werden.

AUSBAU UND ERNEUTES ANBRINGEN DER TÜR

1. Zur Entfernung der Tür, diese vollständig öffnen und die
Haken senken, bis sie sich in entriegelter Position befinden.

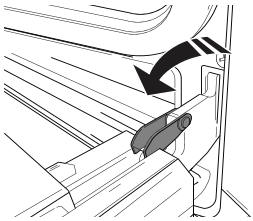

2. Die Tür so weit wie möglich schließen.

Die Tür mit beiden Hände festhalten – diese nicht am Griff
festhalten.

Die Tür einfach entfernen, indem sie weiter geschlossen und
gleichzeitig nach oben (a) gezogen wird, bis sie sich aus ihrem
Sitz löst (b).

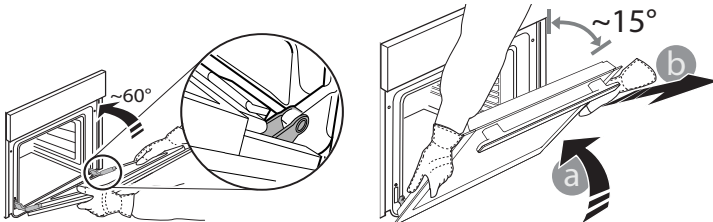

Die Tür seitlich abstellen und auf eine weiche Oberfläche legen.

3. Die Tür erneut anbringen, indem sie zum Ofen geschoben
wird und die Haken der Scharniere auf ihre Sitze ausgerichtet
werden, den oberen Teil auf seinem Sitz sichern.

4. Die Tür senken und anschließend vollständig öffnen.
Die Haken in ihre Ausgangsposition senken: Sicherstellen, dass
die Haken vollständig gesenkt werden.

5. Versuchen, die Tür zu schließen und sicherstellen, dass sie auf
das Bedienfeld ausgerichtet ist. Ist dies nicht der Fall, die oben
aufgeführten Schritte wiederholen.

ZUM REINIGEN AUF - GLASREINIGUNG KLICKEN

1. Nach dem Ausbau der Tür diese auf einer weichen Fläche mit
dem Griff nach unten abgelegt, gleichzeitig die zwei Halte-
klammern drücken und die obere Kante der Tür zu sich ziehen
und entfernen.

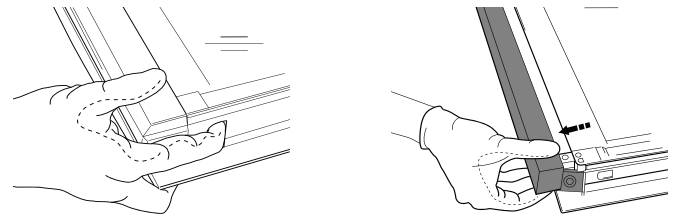

2. Das Innenglas mit beiden Händen anheben und fest halten,
es entfernen und auf eine weiche Fläche legen, um es daraufhin
zu reinigen.

3. Bringen Sie die mittlere Scheibe (mit „1R“ gekennzeichnet) an,
bevor Sie die Innenscheibe wieder einsetzen: Um das Glasschei-
ben richtig einzusetzen, sicherstellen, dass das Zeichen „R“ in
der linken Ecke sichtbar ist. Zuerst die lange Seite des Glas,
die mit einem „R“ gekennzeichnet ist in die Halterungen einsetzen,
dann in die Position absenken. Wiederholen Sie diesen Vorgang
bei beiden Glasscheiben.

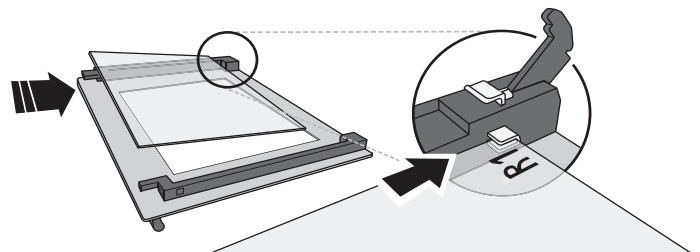

4. Die obere Ecke wieder anbringen: ein Klick bestätigt die
richtige Positionierung. Sicherstellen, dass die Dichtung vor
Wiedereinbau der Tür befestigt wird.

Problem	Mögliche Ursache	Abhilfemaßnahme
Der Backofen funktioniert nicht.	Stromausfall. Trennung von der Stromversorgung.	Überprüfen, ob das Stromnetz Strom führt und der Backofen an das Netz angeschlossen ist. Schalten Sie den Backofen aus und wieder ein, um festzustellen, ob die Störung erneut auftritt.
Das Display zeigt ein „F“ gefolgt von einer Nummer an.	Softwareproblem.	Den nächsten Kundendienst kontaktieren und den Buchstaben oder die Nummer nach dem Buchstaben „F“ angeben.

HILFREICHE TIPPS



Für weitere Informationen die Gebrauchsanleitung auf docs.indesit.eu runterladen

LESEN DER GARTABELLE

Die Tabelle listet die besten Funktionen, Zubehörteile und Einschubebenen auf, die für die verschiedenen Arten von Speisen zu verwenden sind.

Die Garzeiten gelten ab dem Moment, in dem Sie das Gargut in den Ofen geben, die (eventuell erforderliche) Vorheizzeit zählt nicht dazu.

Die Gartemperaturen und -zeiten sind nur Richtwerte und sind von der Menge des Garguts und von den verwendeten Zubehörteilen abhängig. Zunächst die niedrigeren Einstellungen verwenden und, falls das erzielte Garergebnis nicht den Wünschen entspricht, zu den höheren Einstellungen übergehen. Es wird empfohlen, die mitgelieferten Zubehörteile und vorzugsweise Kuchenformen und Backbleche aus dunklem Metall zu verwenden. Es können auch Töpfe und Zubehörteile aus feuerfestem Glas oder Keramik verwendet werden, aber es ist zu berücksichtigen, dass sich die Garzeiten dadurch etwas verlängern.

GLEICHZEITIGES GAREN VERSCHIEDENER SPEISEN

Mit der „Mehrere Einschubebenen“-Funktion können verschiedene Speisen (z. B. Fisch und Gemüse) auf verschiedenen Einschubebenen gleichzeitig gegart werden. Die Speise mit kürzerer Garzeit aus dem Ofen nehmen und die Speisen mit längerer Garzeit weiterhin im Ofen lassen.

TECHNISCHE DATEN

Die technischen Daten mit Angabe der Energiedaten für dieses Gerät können auf der Internetseite docs.indesit.eu heruntergeladen werden

WIE IST DIE GEBRAUCHSANLEITUNG ERHÄLTlich?

> Die Gebrauchsanleitung von der Internetseite docs.indesit.eu herunterladen (den QR-Code verwenden) durch Angabe des Produkthandelscodes.



> Alternativ unseren Kundendienst kontaktieren.

UNSEREN KUNDENDIENST KONTAKTIEREN

Unsere Kontaktdaten sind im Garantiehandbuch zu finden. Wird der Kundendienst kontaktiert, bitte die Codes auf dem Typenschild des Produkts angeben.

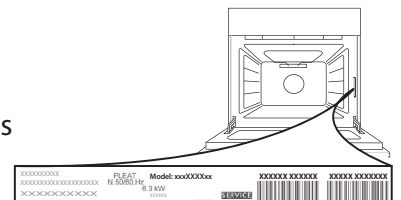

SNELLE REFERENTIEGIDS



WIJ DANKEN U VOOR UW AANKOOP VAN EEN PRODUCT INDESIT

Voor meer informatie en support, gelieve uw product te registreren op www.indesit.com/register



U kunt de Veiligheidsinstructies en de Gids voor Gebruik en Onderhoud downloaden van onze website docs.indesit.eu en de instructies aan de achterzijde van dit boekje opvolgen.



Lees voordat u het apparaat gaat gebruiken zorgvuldig de gids voor Gezondheid en Veiligheid.

PRODUCTBESCHRIJVING

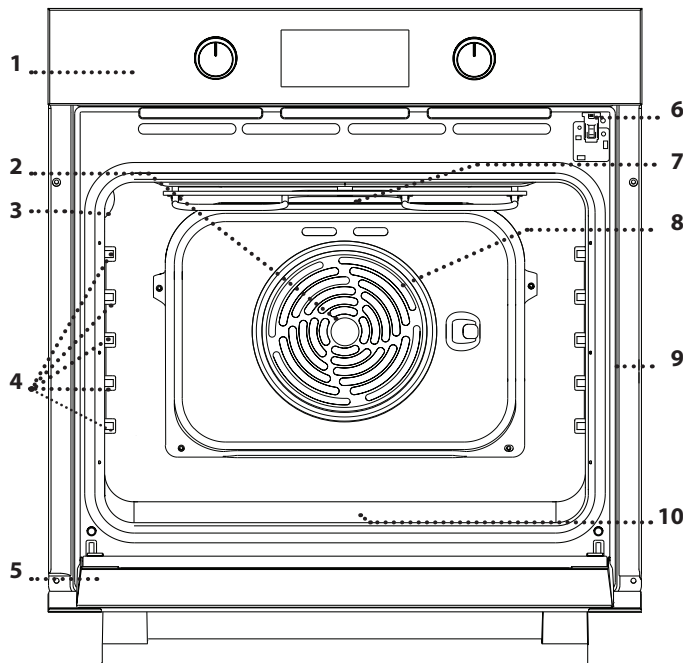

1. Bedieningspaneel
2. Ventilator
3. Lamp
4. Roostergeleiders
(het niveau staat aangegeven op de wand van de bereidingsruimte)
5. Deur
6. Deurvergrendeling
(vergrendelt de deur terwijl het automatisch reinigen wordt uitgevoerd en erna)
7. Bovenste verwarmingselement/grill
8. Circulair verwarmingselement
(niet zichtbaar)
9. Identificatieplaatje (niet verwijderen)
10. Onderste verwarmingselement
(niet zichtbaar)

BEDIENINGSPANEEL

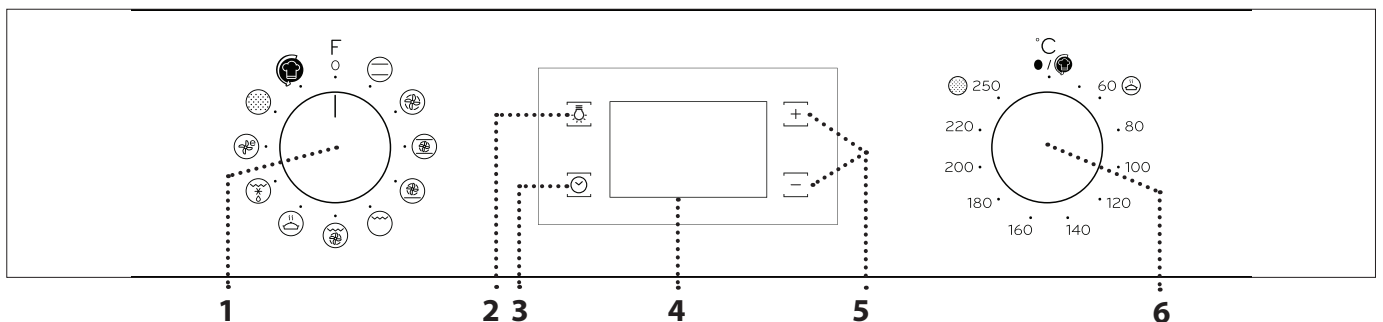

1. SELECTIEKNOP

Om de oven in te schakelen door het selecteren van een functie. Op 0 zetten om de oven uit te schakelen.

2. LAMPJES

Druk erop als de oven is ingeschakeld om de lamp in de ovenruimte in of uit te schakelen.

3. DE TIJD INSTELLEN

Voor toegang tot de instellingen van de bereidingstijd, uitgestelde start en kookwekker. Om de tijd weer te geven wanneer de oven is uitgeschakeld.

4. DISPLAY

5. REGELKNOPPEN

Om de bereidingstijd te veranderen.

6. THERMOSTAATKNOP

Draai om de gewenste temperatuur te selecteren wanneer handmatige functies ingesteld worden. Voor de functie "Turn & Go" laat de knop staan op

ROOSTER

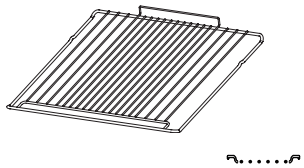

DRUIPPLAAT (INDIEN AANWEZIG)

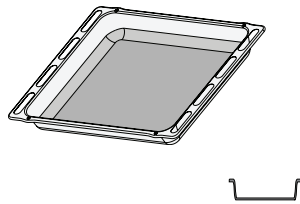

BAKPLAAT

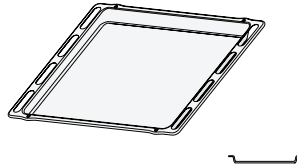

ROOSTERGELEIDERS (indien aanwezig)

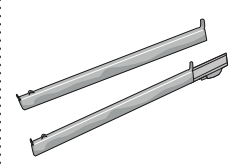

Het aantal en type van accessoires is afhankelijk van het model dat u aangekocht hebt. Bij de Whirlpool Consumenten Service kunt u apart andere accessoires aanschaffen.

GEBRUIK VAN DE ACCESSOIRES

• Plaats de rooster op de gewenste hoogte door hem iets naar boven te kantelen en de geheven achterzijde (naar boven gericht) eerst neer te leggen. Schuif hem horizontaal over de roostergeleiders, zo ver mogelijk. De andere accessoires, zoals de bakplaat, worden horizontaal over de geleiders geschoven.

- Om de oven gemakkelijker te kunnen reinigen, kunnen de geleiders worden verwijderd: trek ze uit hun zitting.
- De roostergeleiders kunnen op elk niveau worden verwijderd of gemonteerd.

FUNCTIES



CONVENTIONEEL

Voor het bereiden van gerechten op één steunhoogte.



MULTILEVEL

Voor het gelijktijdig bereiden van verschillende gerechten op verschillende steunhoogtes (maximaal drie) die dezelfde bereidingstemperatuur hebben. Met deze functie worden er geen geuren van het ene naar het andere gerecht overgebracht.



XL COOKING

Voor het braden van grote stukken vlees (meer dan 2,5 kg). Het is raadzaam om het vlees tijdens de bereiding te draaien, zodat beide kanten gelijkmatig bruin worden. Het is ook raadzaam om het stuk vlees zo vochtig mogelijk te houden, om te voorkomen dat het teveel uitdroogt.



PIZZA

Voor het bakken van verschillende soorten en formaten pizza en brood. Verwissel halverwege de bereiding de positie van de ovenplaten.



GRILL

Voor het grillen van karbonades, spiesen en worstjes, gratineren van groenten of om brood te roosteren. Voor het grillen van vlees wordt geadviseerd de bakplaat te gebruiken om het braadvet op te vangen: Plaats de pan op één van de niveaus onder de rooster en voeg 200 ml drinkwater toe.



GRATIN

Voor het grillen van grote stukken vlees (lamsbouten, rosbief, hele kip). Er wordt geadviseerd de bakplaat te gebruiken om het braadvet op te vangen: Plaats de pan op één van de niveaus onder de rooster en voeg 200 ml drinkwater toe.



WARMHOUDEN

Om zoet of hartig deeg goed te laten rijzen. Om de kwaliteit van het rijzen niet in gevaar te brengen, de functie niet inschakelen als de oven nog heet is na een bereidingscyclus.



FREASY COOK

Alle verwarmingselementen en de ventilator gaan aan en garanderen zo een correcte en uniforme verspreiding van de warmte in de hele oven. Voorverwarmen is niet nodig in deze modaliteit. Deze modaliteit is vooral aangewezen voor het snel bereiden van voorverpakte etenswaren (diepgevroren of voorgekookt). De beste resultaten worden verkregen wanneer maar één niveau tegelijk gebruikt wordt.



ECO MULTILEVEL

Gevulde braadstukken en stukken vlees op één steunhoogte bereiden. Door zachte, intermitterende luchtcirculatie wordt voorkomen dat het voedsel teveel uitdroogt. Wanneer deze functie in gebruik is zal het ECO licht tijdens de bereiding uitgeschakeld blijven, maar het kan weer tijdelijk worden ingeschakeld door te drukken op .



AUTOMATISCHE PYROLYSEREINIGING VAN DE OVEN

Voor het verwijderen van vetspatten, met een cyclus bij zeer hoge temperatuur (meer dan 400 °C).



TURN & GO







Deze functie selecteert automatisch een ideale temperatuur en tijd voor het bereiden van een groot aantal recepten zoals vlees, vis, pasta, zoetigheden en groenten. Activeer de functie wanneer de oven koud is.

HET APPARAAT VOOR HET EERST GEBRUIKEN

1. DE TIJD INSTELLEN

Stel de tijd in wanneer u de oven voor de eerste keer aan zet: Druk op  tot het  pictogram en de twee cijfers van de uren beginnen knipperen op de display.





Gebruik  of  om de uren in te stellen en druk op  om te bevestigen. Op het display gaan de twee cijfers die de minuten aangeven knipperen. Gebruik  of  om de minuten in te stellen en druk op  om te bevestigen.



Let op: Wanneer het pictogram  knippert, bijvoorbeeld na een langdurige stroomuitval, moet de tijd gereset worden.

2. HET STROOMVERBRUIK INSTELLEN

De oven is geprogrammeerd om te werken aan een vermogen van minder dan 2,9 kW ("Lo"): Om de oven te laten werken aan een vermogen dat compatibel is met een huishoudelijke stroomvoorziening van meer dan 3 kW ("Hi"), dient u de instellingen te wijzigen. Om het menu voor de wijzigingen te openen, draai de *selectieknop* op , en zet hem dan terug op 0.

Druk onmiddellijk op  en  en houd vijf seconden ingedrukt.



Gebruik  of  om de instelling te veranderen, druk vervolgens op  en houd tenminste twee seconden ingedrukt om te bevestigen.

3. DE OVEN VERWARMEN

Een nieuwe oven kan geuren afgeven die tijdens het productieproces zijn achtergebleven: dit is volkomen normaal. Voordat u begint met het bereiden van voedsel, raden we daarom aan om de lege oven te verwarmen, om alle mogelijke geuren te verwijderen. Verwijder alle beschermende karton of transparante film uit de oven en verwijder eventuele accessoires aan de binnenkant.

Verwarm de oven tot 250 °C gedurende ongeveer een uur met de functie "XL Cooking". De oven moet leeg zijn gedurende deze tijd.

Volg de instructies voor de correcte instelling van de functie.

Let op: Het is raadzaam de ruimte te luchten na het eerste gebruik van het apparaat.

DAGELIJKS GEBRUIK

1. SELECTEREN VAN EEN FUNCTIE

Om een functie te selecteren, draai de *keuzeknop* op het symbool van de gewenste functie: de display licht op en er is een geluidssignaal hoorbaar.



2. EEN FUNCTIE INSCHAKELEN

HANDMATIG

Om de geselecteerde functie te starten, draai de *thermostaatknop* op de gewenste temperatuur.



Let op: Tijdens de bereiding kan de functie gewijzigd worden door de *keuzeknop* te draaien of de temperatuur te regelen met de *thermostaatknop*.

De functie zal niet starten als de *thermostaatknop* op  staat.

U kunt het einde van de bereiding (alleen wanneer een bereidingstijd ingesteld wordt) en een kookwekker selecteren.

TURN & GO

Om de functie "Turn & Go" te starten, selecteer de

functie door de *keuzeknop* te draaien op het relevante pictogram. De *thermostaatknop* blijft op  staan. Om de bereiding te eindigen, zet de *keuzeknop* op "0".

Let op: Om de beste resultaten te verkrijgen met de functie "Turn & Go", volg de aanbevolen gewichten voor elk soort van etenswaar in de volgende tabel.

Gerecht	Recept	Gewicht (kg)
Vlees	Gebraden kalfsvlees, saignant rosbeef	0,6 - 0,7
	Kip / Lamsbout in stukken	1,0 - 1,2
Vis	Zalmfilet / Gebakken vis (heel)	0,9 - 1,0
	Vis in papillote	0,8 - 1,0
Groenten	Gevulde groenten	1,8 - 2,5
	Groentetaart	1,5 - 2,5
Hartige taarten	Quiche lorraine / Flan	1,0 - 1,5
Pasta	Lasagne / Pasta- of rijsttimbaaltje	1,5 - 2,0
Gebak	Gerezen taart / Plumcake	0,9 - 1,2
	Gebakken appels	1,0 - 1,5
Brood	Heel brood	0,5 - 0,6
	Baguettes	0,5 - 0,8

3. VOORVERWARMEN



Eens de functie gestart is, is een geluidssignaal hoorbaar en knippert een pictogram  op de display om aan te geven dat het voorverwarmen begonnen is. Na deze fase is een signaal hoorbaar en toont het vaste pictogram  op de display dat de oven de ingestelde temperatuur bereikt heeft: plaats het voedsel in de oven en ga verder met het bereiden.

Let op: Het voedsel in de oven plaatsen vooraleer de fase van de voorverwarming afgelopen is zal een negatief effect hebben op het uiteindelijk resultaat van de bereiding.



. PROGRAMMEREN VAN DE BEREIDING

Selecteer een functie om de bereiding te programmeren.

DUUR

Blijf drukken op  tot het pictogram  en "00:00" knipperen op de display.



Gebruik  of  om de gewenste bereidingstijd in te stellen en druk dan op  om te bevestigen.



Activeer de functie door de *thermostaatknop* te draaien op de gewenste temperatuur: er klinkt een geluidssignaal en op de display wordt aangegeven dat de bereiding klaar is.

Opmerkingen: Om de ingestelde bereidingstijd te annuleren, blijf drukken op  tot het pictogram  begint te knipperen op de display, en gebruik dan  om de bereidingstijd te resetten op "00:00". Deze bereidingstijd behelst een voorverwarmingsfase.

PROGRAMMEREN VAN EINDE BEREIDING/UITGESTELDE START

Nadat een bereidingstijd ingesteld is, kan de start uitgesteld worden door de eindtijd te programmeren: druk op  tot het pictogram  en de huidige tijd beginnen knipperen op de display.



Gebruik  of  om de gewenste eindtijd van de bereiding te regelen en druk op  om te bevestigen. Activeer de functie door de *thermostaatknop* te draaien op de gewenste temperatuur: de functie blijft in pauze en start automatisch na een tijdsperiode die berekend is om de bereiding te laten eindigen op het uur dat u gekozen hebt.

Opmerkingen: Om de instelling te annuleren, zet de oven uit door de *keuzeknop* in de stand **0** te draaien.

Opmerkingen: Startuitstel is niet beschikbaar voor de functies Grill en Turbo Grill.

EINDE BEREIDINGSTIJD

Er klinkt een geluidssignaal en op de display wordt aangegeven dat de functie klaar is.





Draai de *keuzeknop* om een andere functie te selecteren of in de stand "0" om de oven uit te zetten.



Let op: Als de kookwekker actief is, toont de display "END" afgewisseld met de resterende tijd.

. INSTELLEN VAN DE KOOKWEKKER



Deze optie stopt of start de bereiding niet maar geeft u de mogelijkheid om de display te gebruiken als kookwekker (timer), zowel wanneer een functie actief is als wanneer de oven uit staat.

Blijf drukken op  tot het pictogram  en "00:00" knipperen op de display.



Gebruik  of  om de tijd te regelen en druk op  om te bevestigen.

U hoort een geluidssignaal eens de kookwekker afgeteld heeft tot aan de geselecteerde bereidingstijd.

Opmerkingen: Om de kookwekker te annuleren, druk op  tot het pictogram  knippert en gebruik dan om de tijd te resetten op "00:00".

. FUNCTIE AUTOMATISCHE REINIGING - PYRO

Raak de oven niet aan tijdens de Pyrocyclus.

Houd kinderen en dieren uit de buurt van de oven tijdens en na het uitvoeren van de Pyrocyclus (totdat de ruimte klaar is met luchten).



































































De accessoires - ook de roostergeleiders - moeten uit de oven worden gehaald voordat u de functie inschakelt. Indien de oven onder een kookplaat is geïnstalleerd dient u ervoor te zorgen dat alle branders of elektrische kookplaten uitgeschakeld zijn tijdens de zelfreinigingscyclus.







Voor een optimale reiniging dient het ergste vuil met een vochtige spons verwijderd te worden voordat de Pyrofunctie wordt gebruikt. Het is raadzaam de Pyrofunctie alleen uit te voeren wanneer het apparaat erg vervuild is of tijdens het bereiden vieze geuren afgeeft.





Om de functie automatische reiniging te activeren, draai de *selectieknop* en de *thermostaatknop* op het pictogram . De functie wordt automatisch geactiveerd, de deur wordt vergrendeld en het licht in de oven wordt uitgeschakeld: Op het display wordt de resterende tijd tot het einde weergegeven, afgewisseld met "Pyro".

Zodra de cyclus is voltooid blijft de deur vergrendeld tot de temperatuur in de oven gedaald is tot een veilig niveau. Tijdens en na het uitvoeren van de Pyrocyclus de ruimte luchten.

BEREIDINGSTABEL

RECEPT	FUNCTIE	VOORVER- WARMEN	TEMPERATUUR (°C)	DUUR (MIN)	NIVEAU EN ACCESSOIRES
Luchtig gebak		Ja	160 - 180	30 - 90	2/3 
		Ja	160 - 180	30 - 90	4 1  
Gevulde taart (kwarktaart, strudel, vruchtentaart)		Ja	160 - 200	35 - 90	2 
		Ja	160 - 200	40 - 90	4 2  
Koekjes / taartjes		Ja	160 - 180	20 - 45	3 
		Ja	150 - 170	20 - 45	4 2  
		Ja	150 - 170	20 - 45	5 3 1   
Soesjes		Ja	180 - 210	30 - 40	3 
		Ja	180 - 200	35 - 45	4 2  
		Ja	180 - 200	35 - 45	5 3 1   
Meringues		Ja	90	150 - 200	3 
		Ja	90	140 - 200	4 2  
		Ja	90	140 - 200	5 3 1   
Pizza/Brood		Ja	190 - 250	15 - 50	1 / 2 
		Ja	190 - 250	20 - 50	4 2  
Diepvriespizza's		Ja	250	10 - 20	3 
		Ja	230 - 250	10 - 25	4 2  
Hartige taarten (groentetaart, quiche)		Ja	180 - 200	40 - 55	3 
		Ja	180 - 200	45 - 60	4 2  
		Ja	180 - 200	45 - 60	5 3 1   
Pasteitjes/bladerdeeghapjes		-	190 - 200	20 - 30	3 
		-	180 - 190	20 - 40	4 2  
		-	180 - 190	20 - 40	5 3 1   
Lasagne / gebakken Pasta/ cannelloni / ovenschotels		Ja	190 - 200	45 - 65	2 

FUNCTIES							
	Conventioneel	Grill	Gratin	Pizza	Multilevel	XL Cooking	ECO multilevel

ACCESSOIRES					
	Rooster	Bakvorm of taartvorm op het rooster	Bakplaat/opvangbak of bakvorm of taartvorm op rooster	Droopplaat / Ovenschaal	Droopplaat / Ovenschaal met 200 ml water

RECEPT	FUNCTIE	VOORVER- WARMEN	TEMPERATUUR (°C)	DUUR (MIN)	NIVEAU EN ACCESSOIRES		
Lamsvlees/kalfsvlees/ rundvlees/ varkensvlees 1 kg		Ja	190 - 200	80 - 110	3 		
Gebraden varkensvlees met korst 2 kg		Ja	180 - 190	110 - 150	2 		
Kip/konijn/eend 1 kg		Ja	200 - 230	50 - 100	2 		
Kalkoen/gans 3 kg		-	190 - 200	100 - 160	2 		
Vis uit de oven/in folie (filet, heel)		Ja	170 - 190	30 - 50	2 		
Gevulde groenten (tomaten, courgettes, aubergines)		Ja	180 - 200	50 - 70	2 		
Geroosterd brood		-	250	2 - 6	5 		
Visfilets/moten		-	230 - 250	20 - 30*	4 	3 	
Worstjes/spiesen/ spareribs/ hamburgers		-	250	15 - 30*	5 	4 	
Gebraden kip 11,3 kg		Ja	200 - 220	55 - 70**	2 	1 	
Rosbief rosé 1 kg		Ja	200 - 210	35 - 50**	3 		
Lamsbout/schenkel		Ja	200 - 210	60 - 90**	3 		
Geb. aardappelen		Ja	200 - 210	35 - 55**	3 		
Groentegratin		-	200 - 210	25 - 55	3 		
Vlees en aardappelen		Ja	190 - 200	45 - 100***	4 	1 	
Vis en groente		Ja	180	30 - 50***	4 	1 	
Lasagne en Vlees		Ja	200	50 - 100***	4 	1 	
Complete maaltijd: vruchtentaart (niveau 5) / lasagne (niveau 3) / vlees(niveau 1)		Ja	180 - 190	40 - 120***	5 	3 	1
Gebraad/gevulde braadstukken		-	170 - 180	100 - 150	2 		

De bereidingstijd is exclusief de voorverwarmingsfase: het is aangeraden het voedsel in de oven te doen en de bereidingstijd pas in te stellen nadat de gewenste temperatuur bereikt is.

* Draai het vlees halverwege de bereidingstijd om.

** Draai het voedsel na tweederde van de bereidingstijd om (indien nodig).

*** Geschatte tijdsduur: Gerechten kunnen op verschillende tijdstippen afhankelijk van de persoonlijke voorkeur uit de oven worden verwijderd.

Download de Handleiding van docs.indesit.eu voor de tabel met geteste recepten, ingevuld voor de certificatieoverheden in overeenstemming met de norm IEC 60350-1.

FUNCTIES							
	Conventioneel	Grill	Gratin	Pizza	Multilevel	XL Cooking	ECO multilevel
ACCESSOIRES							
	Rooster	Bakvorm of taartvorm op het rooster	Bakplaat/opvangbak of bakvorm of taartvorm op rooster	Bakplaat/opvangbak of bakvorm of taartvorm op rooster	Druipplaat / Ovenschaal	Druipplaat / Ovenschaal	Druipplaat / Ovenschaal met 200 ml water

ONDERHOUD EN REINIGING



Download voor meer informatie de Gids voor Gebruik en Onderhoud op docs.indesit.eu

Gebruik geen stoomreinigers.

Gebruik tijdens alle werkzaamheden beschermende handschoenen.

Voer de benodigde werkzaamheden uit wanneer de oven is afgekoeld.

Trek de stekker uit het stopcontact.

Gebruik geen staalwol, schuursponsjes of schurende/bijtende reinigingsproducten, omdat deze het oppervlak van het apparaat kunnen beschadigen.

EXTERNE OPPERVLAKKEN

Reinig de oppervlakken met een vochtig microvezeldoekje. Als ze zeer vuil zijn, voeg dan een paar druppels neutraal afwasmiddel toe aan het water. Droog af met een droge doek. Gebruik geen bijtende of schurende reinigingsmiddelen. Als een dergelijk product per ongeluk in contact komt met de oppervlakken het apparaat, verwijder het dan onmiddellijk met een vochtig microvezeldoekje.

INTERNE OPPERVLAKKEN

• Na elk gebruik moet de oven afkoelen en dan gereinigd worden, bij voorkeur wanneer die nog warm is, om afzettingen of vlekken veroorzaakt door voedselresten te verwijderen. Laat voor het drogen van condens die zich heeft gevormd vanwege het breiden van voedsel met een hoog vochtgehalte de oven volledig afkoelen en veeg het af met een doek of spons.

Als hardnekkig vuil zich op de interne oppervlakken bevindt, is het raadzaam de functie automatische reiniging uit te voeren voor optimale reinigingsresultaten.

- De deur kan makkelijk verwijderd en teruggeplaatst worden om de ruit te reinigen .
- Maak het glas van de deur schoon met een geschikt vloeibaar reinigingsmiddel.

ACCESSOIRES

Laat de accessoires na gebruik weken in water met afwasmiddel. Pak ze vast met handschoenen als ze nog heet zijn. Voedselresten kunnen met een afwasborstel of met een sponsje worden verwijderd.

DE DEUR VERWIJDEREN EN TERUGPLAATSEN

1. Om de deur te verwijderen opent u deze volledig en brengt u de vergrendelingen naar beneden totdat ze ontgrendeld zijn.

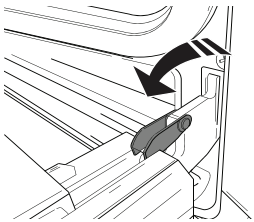

2. Sluit de deur zo ver mogelijk.

Houd de deur stevig met beide handen beet – niet vasthouden aan de handgreep.

Verwijder de deur door deze te blijven sluiten en tegelijkertijd omhoog te trekken (a) totdat het loshaakt (b).

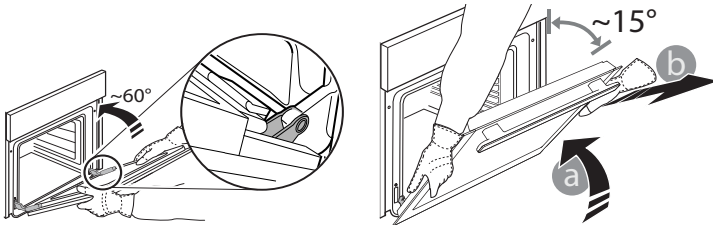

Zet de deur opzij en laat deze op een zachte ondergrond rusten.

3. Monteer de deur opnieuw door deze te bewegen in de richting van de oven, de haken van de scharnieren uit te lijnen met de zitting en het bovenste deel op de zitting vast te zetten.

4. Laat de deur zakken en doe deze vervolgens volledig open. Breng de vergrendelingen omlaag naar hun oorspronkelijke positie: zorg ervoor dat ze volledig naar beneden staan.

5. Probeer de deur te sluiten en controleer of het in lijn met het bedieningspaneel is. Als dit niet het geval is herhaalt u de

bovenstaande stappen.

KLIK OM TE REINIGEN - DE RUIT REINIGEN

1. Verwijder de deur en leg die neer op een zacht oppervlak met de handgreep naar onder toe. Druk tegelijk op de twee clips en verwijder de bovenrand van de deur door het naar u toe te trekken.

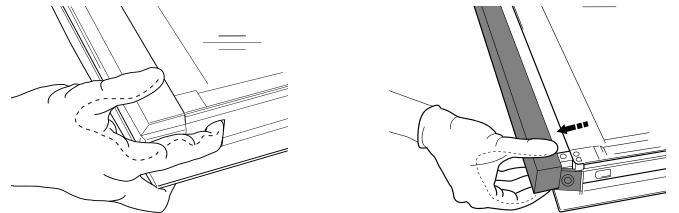

2. Hef en hou de binnenruit stevig vast met beide handen, verwijder het en leg het op een zacht oppervlak vooraleer het te reinigen.

3. Zet de tussenruit (met merk "1R") op zijn plaats alvorens de binnenruit te plaatsen: Om de ruiten correct terug te plaatsen, zorg ervoor dat het merk "R" zichtbaar is in de linkerhoek. Breng eerst de lange zijde van de ruit met het merk "R" in de zittingen, en breng de ruit omlaag tot die op zijn plek komt. Herhaal deze procedure voor beide glasruiten.

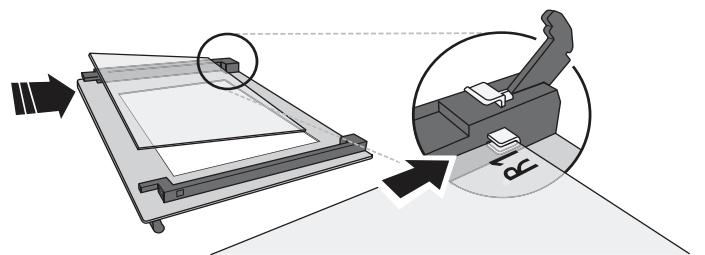

4. Plaats de bovenrand terug: een klik geeft aan dat hij goed zit. Zorg ervoor dat de afdichting goed zit vooraleer de deur terug te plaatsen.

Probleem	Mogelijke oorzaak	Oplossing
De oven werkt niet.	Stroomonderbreking. Koppel het los van het elektriciteitsnet.	Controleer of het elektriciteitsnet spanning heeft en of de oven is aangesloten. Zet de oven uit en weer aan, om te controleren of het probleem opgelost is.
Op de display verschijnt de letter "F" gevolgd door een nummer.	Softwareprobleem.	Neem contact op met de dichtstbijzijnde Consumentenservice en vermeld de letter of het nummer dat volgt op de letter "Err".

NUTTIGE TIPS

Download voor meer informatie de Gids voor Gebruik en Onderhoud op docs.indesit.eu

LEZEN VAN DE BEREIDINGSTABEL

De tabel geeft een overzicht van de beste functie, accessoires en het niveau voor het bereiden van verschillende soorten gerechten.
De bereidingstijden gelden vanaf het moment dat het gerecht in de oven wordt gezet, zonder de voorverwarmingstijd (indien nodig).
De bereidingstemperaturen zijn bij benadering en zijn afhankelijk van de hoeveelheid voedsel en het type accessoire dat wordt gebruikt. Gebruik eerst de laagste aanbevolen waarden. Als de bereiding niet naar wens is, kunt u hogere waarden gebruiken. Geadviseerd wordt om de bijgeleverde accessoires te gebruiken en indien mogelijk taartvormen en bakplaten van donker metaal. U kunt ook vuurvaste of aardewerk pannen en accessoires gebruiken; de bereidingstijden zijn dan iets langer.

HET TEGELIJKERTIJD BEREIDEN VAN VERSCHILLENDE GERECHTEN

Met de functie "Multilevel" kunt u verschillende gerechten (zoals vis en groenten) gelijktijdig op verschillende steunhoogtes bereiden. Haal de gerechten die klaar zijn uit de oven en laat de gerechten die meer tijd nodig hebben in de oven staan.

PRODUCT

 De productfiche met energiegegevens van dit apparaat kan gedownload worden van onze website docs.indesit.eu

HOE DE GIDS VOOR GEBRUIK EN ONDERHOUD TE VERKRIJGEN

>  Download de Gids voor Gebruik en Onderhoud op onze website docs.indesit.eu (u kunt deze QR code gebruiken), onder vermelding van de handelscode van het product.



> U kunt ook contact opnemen met onze Consumentenservice.

CONTACT OPNEMEN MET CONSUMENTENSERVICE

Onze contactgegevens staan in de garantiehandleiding.
Wanneer u contact opneemt met de Consumentenservice gelieve de codes te vermelden die op het identificatieplaatje van het apparaat staan.

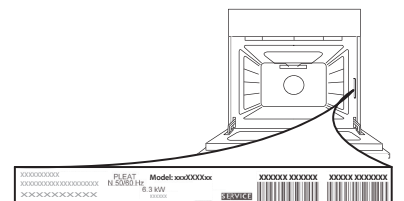

DAILY REFERENCE GUIDE



THANK YOU FOR PURCHASING AN INDESIT PRODUCT

To receive more comprehensive help and support, please register your product at www.indesit.com/register



You can download the Safety Instructions and the Use and Care Guide by visiting our website docs.indesit.eu and following the instructions on the back of this booklet.



Before using the appliance carefully read the Health and Safety guide.

PRODUCT DESCRIPTION

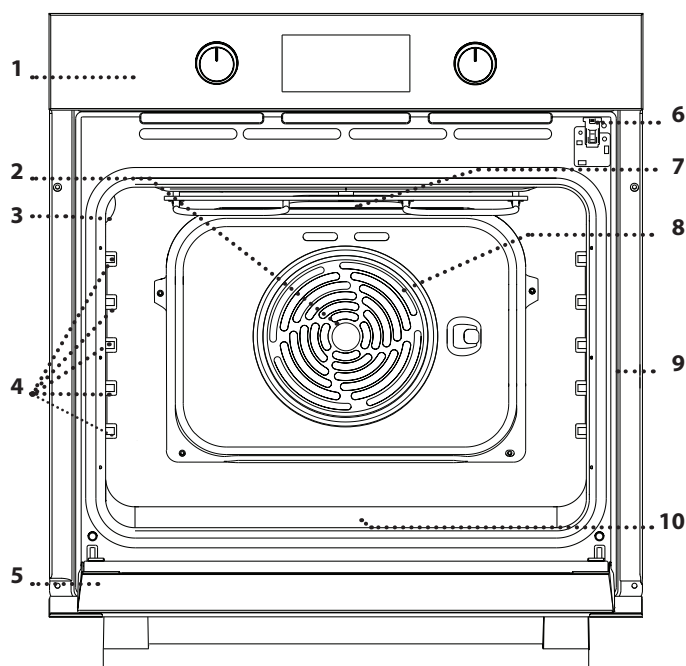

1. Control panel
2. Fan
3. Lamp
4. Shelf guides
(the level is indicated on the wall of the cooking compartment)
5. Door
6. Door lock
(locks the door while automatic cleaning is in progress and afterwards)
7. Upper heating element/grill
8. Circular heating element
(non-visible)
9. Identification plate
(do not remove)
10. Bottom heating element
(non-visible)

CONTROL PANEL

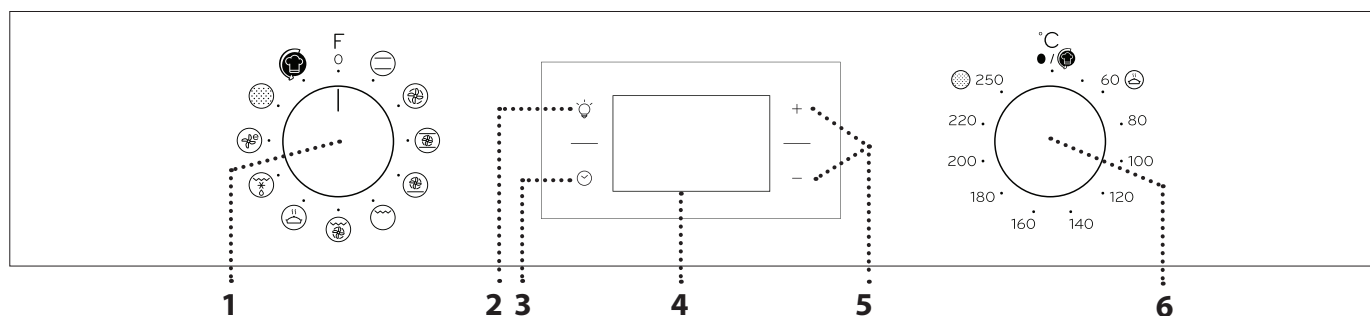

1. SELECTION KNOB

For switching the oven on by selecting a function. Turn to the position **O** to switch the oven off.

2. LIGHT

With the oven switched on, press to turn the oven compartment lamp on or off.

3. SETTING THE TIME

For accessing the cooking time settings, delayed start and timer. For displaying the time when the oven is off.

4. DISPLAY

5. ADJUSTMENT BUTTONS

For changing the cooking time settings.

6. THERMOSTAT KNOB

Turn to select the temperature you require when activating manual functions. For "Turn & Go" function keep on .

WIRE SHELF

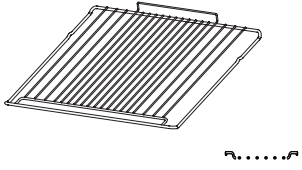

BAKING TRAY

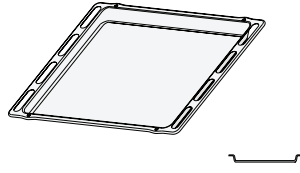

The number and the type of accessories may vary depending on which model is purchased. Other accessories can be purchased separately from the After-sales Service.

USING THE ACCESSORIES

• Insert the wire shelf onto the level you require by holding it tilted slightly upwards and resting the raised rear side (pointing upwards) down first. Then slide it horizontally along the shelf guide as far as possible.

• The other accessories, such as the baking tray, are inserted horizontally by sliding them along the shelf guides.
• The shelf guides can be removed to facilitate the oven cleaning: pull them to remove from their seats.

FUNCTIONS

CONVENTIONAL
For cooking any kind of dish on one shelf only.

MULTILEVEL
For cooking different foods that require the same cooking temperature on several shelves (maximum three) at the same time. This function can be used to cook different foods without odours being transferred from one food to another.

XL COOKING
For cooking large joints of meat (above 2.5 kg). We recommend turning the meat over during cooking to ensure that both sides brown evenly. We also recommend basting the joint every so often to prevent it from drying out excessively.

PIZZA
For baking different types and sizes of pizza and bread. It is a good idea to swap the position of the baking trays halfway through cooking.

GRILL
For grilling steaks, kebabs and sausages, cooking vegetables au gratin or toasting bread. When grilling meat, we recommend using a Baking tray to collect the cooking juices: position the pan on any of the levels below the wire shelf and add 200 ml of drinking water.

GRATIN
For roasting large joints of meat (legs, roast beef, chicken). We recommend using a Baking tray to collect the cooking juices: position the pan on any of the levels below the wire shelf and add 200 ml of drinking water.

KEEP WARM
For helping sweet or savoury dough to rise effectively. To maintain the quality of proving, do not activate the function if the oven is still hot following a cooking cycle.

FREASY COOK
All the heating elements and the fan come on, guaranteeing the distribution of heat consistently and uniformly throughout the oven. Pre-heating is not necessary for this cooking mode. This mode is especially recommended for cooking pre-packed food quickly (frozen or pre-cooked). The best results are obtained if you use one cooking rack only.



ECO FORCED AIR
For cooking roasts and stuffed roasting joints on a single shelf. Food is prevented from drying out excessively by gentle, intermittent air circulation. When this ECO function is in use, the light will remain switched off during cooking but can be switched on again by pressing .

AUTOMATIC OVEN CLEANING - PYRO
For eliminating cooking spatters using a cycle at very high temperature (over 400 °C).



TURN & GO
This function automatically selects an ideal temperature and time for baking a wide range of recipes including meat, fish, pasta, sweets and vegetables. Activate the function when the oven is cold.

USING THE APPLIANCE FOR THE FIRST TIME

1. SETTING THE TIME

You will need to set the time when you switch on the appliance for the first time: Press  until the  icon and the two digits for the hour start flashing on the display.



Use + or - to set the hour and press  to confirm. The two digits for the minutes will start flashing. Use + or - to set the minutes and press  to confirm.

Please note: When the  icon is flashing, for example following lengthy power outages, you will need to reset the time.

2. HEAT THE OVEN

The oven is programmed to work at a power of less than 2.9 kW ("Lo"): To operate the oven at a power that is compatible with a domestic power supply of greater than 3 kW ("Hi"), you will need to change the settings.

To go to the change menu, turn the *selection knob* to , then turn it back to 0

Press and hold + and - for five seconds immediately afterwards.



Use + or - to change the setting, then press and hold  for at least two seconds to confirm.

3. HEAT THE OVEN

A new oven may release odours that have been left behind during manufacturing: this is completely normal.

Before starting to cook food, we therefore recommend heating the oven with it empty in order to remove any possible odours.

Remove any protective cardboard or transparent film from the oven and remove any accessories from inside it. Heat the oven to 250 °C for about one hour, preferably using the "XL Cooking" function. The oven must be empty during this time.

Follow the instructions for setting the function correctly.

Please note: It is advisable to air the room after using the appliance for the first time.

DAILY USE

1. SELECT A FUNCTION

To select a function, turn the *selection knob* to the symbol for the function you require: the display will light up and an audible signal will sound.



2. ACTIVATE A FUNCTION

MANUAL

To start the function you have selected, turn the *thermostat knob* to set the temperature you require.

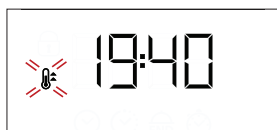

Please note: During cooking you can change the function by turning the *selection knob* or adjust the temperature by turning the *thermostat knob*.

The function will not start if the *thermostat knob* is on . You can set the cooking time, cooking end time (only if you set a cooking time) and a timer.



TURN & GO

To start the "Turn & Go" function, select the function turning the *selection knob* on the relevant icon, keeping the *thermostat knob* on the  icon. To end the cooking, turn the *selection knob* on "0".

Please note: To obtain the best cooking results using the "Turn & Go" function, follow the suggested weights for each kind of food in the following table.

Food	Recipe	Weight (kg)
Meat	Roast veal, Roast Beef rare	0,6 - 0,7
	Chicken / Leg of lamb in pieces	1,0 - 1,2
Fish	Salmon fillet / Baked fish (whole)	0,9 - 1,0
	Fish en papillote	0,8 - 1,0
Vegetables	Stuffed vegetables	1,8 - 2,5
	Vegetable pie	1,5 - 2,5
Salty cakes	Quiche lorraine / Flan	1,0 - 1,5
Pasta	Lasagne / Timbale of pasta or rice	1,5 - 2,0
Pastry	Leavened cake / Plum cake	0,9 - 1,2
	Baked apples	1,0 - 1,5
Bread	Bread loaf	0,5 - 0,6
	Baguettes	0,5 - 0,8

3. PREHEATING AND RESIDUAL HEAT

Once the function starts, an audible signal and a flashing icon  on the display indicate that the preheating phase has been activated. At the end of this phase, an audible signal and the fixed icon  on the display will indicate that the oven has reached the set temperature: at this point, place the food inside and proceed with cooking.

Please note: Placing the food in the oven before preheating has finished may have an adverse effect on the final cooking result.



After cooking and with the function deactivated, the icon  may continue to remain visible on the display even after the cooling fan has switched off to indicate that there is residual heat in the compartment.

Please note: The time after which the icon switches off varies because it depends on a series of factors such as ambient temperature and function used. In any case, the product should be considered to be off when the pointer on the selection knob is at "0".

4. PROGRAMMING COOKING

You will need to select a function before you can start programming cooking.



DURATION

Keep pressing  until the  icon and "00:00" start flashing on the display.



Use $+$ or $-$ to set the cooking time you require, then press  to confirm.

Activate the function by turning the *thermostat knob* to the temperature you require: an audible signal will sound and the display will indicate that cooking is complete.

Notes: To cancel the cooking time you have set, keep pressing  until the  icon starts flashing on the display, then use $-$ to reset the cooking time to "00:00". This cooking time includes a preheating phase.

PROGRAMMING THE END COOKING TIME/ DELAYED START

After a cooking time has been set, starting the function can be delayed by programming its end time: press  until the  icon and the current time start flashing on the display.



Use $+$ or $-$ to set the time you want cooking to end and press  to confirm.

Activate the function by turning the *thermostat knob* to the temperature you require: the function will remain paused until it starts automatically after the period of time that has been calculated in order for cooking to finish at the time you have set.

Notes: To cancel the setting, switch the oven off by turning the *selection knob* to the **0** position.

Notes: Delay to start functionality is not available for Grill and Turbo Grill functions.

END OF COOKING

An audible signal will sound and the display will indicate that the function has finished.





Turn the *selection knob* to select a different function or to position "0" to switch the oven off.

Please note: If the timer is active, the display will show "END" alternately with the remaining time.

5. SETTING THE TIMER



This option does not interrupt or program cooking but allows you to use the display as a timer, either during while a function is active or when the oven is off.

Keep pressing  until the  e "00:00" icon and "00:00" start flashing on the display.



Use $+$ or $-$ to set the time you require and press  to confirm.

An audible signal will sound once the timer has finished counting down the selected time.

Notes: To cancel the timer, keep pressing  until the  icon starts flashing, then use $-$ to reset the time to "00:00".

6. AUTOMATIC CLEANING FUNCTION – PYRO

Do not touch the oven during the Pyro cycle.

Keep children and animals away from the oven during and after (until the room has finished airing) running the Pyro cycle.



































































Remove all accessories - including shelf guides - from the oven before activating the function. If the oven is installed below a hob, make sure that all the burners or electric hotplates are switched off while running the selfcleaning cycle.













For optimum cleaning results, remove the worst soiling with a damp sponge before using the Pyro function. We recommend only running the Pyro function if the appliance contains heavy soiling or gives off bad odours during cooking.

To activate the automatic cleaning function, turn the *selection knob* and the *thermostat knob* to the  icon. The function will be activated automatically, the door locked and the light inside the oven switched off: The display will show the time remaining to the end, alternating with "Pyro".

Once the cycle has been completed, the door remains locked until the temperature inside the oven has returned to a safe level. Air the room during and after running the Pyro cycle.

COOKING TABLE

RECIPE	FUNCTION	PREHEATING	TEMPERATURE (°C)	DURATION (MIN)	LEVEL AND ACCESSORIES
Leavened cakes		Yes	160 - 180	30 - 90	2/3 
		Yes	160 - 180	30 - 90	4 1  
Filled cake (cheese cake, strudel, fruit pie)		Yes	160 - 200	35 - 90	2 
		Yes	160 - 200	40 - 90	4 2  
Biscuits/tartlets		Yes	160 - 180	20 - 45	3 
		Yes	150 - 170	20 - 45	4 2  
		Yes	150 - 170	20 - 45	5 3 1   
Choux buns		Yes	180 - 210	30 - 40	3 
		Yes	180 - 200	35 - 45	4 2  
		Yes	180 - 200	35 - 45	5 3 1   
Meringues		Yes	90	150 - 200	3 
		Yes	90	140 - 200	4 2  
		Yes	90	140 - 200	5 3 1   
Pizza / bread		Yes	190 - 250	15 - 50	1 / 2 
		Yes	190 - 250	20 - 50	4 2  
Frozen pizza		Yes	250	10 - 20	3 
		Yes	230 - 250	10 - 25	4 2  
Salty cakes (vegetable pie, quiche)		Yes	180 - 200	40 - 55	3 
		Yes	180 - 200	45 - 60	4 2  
		Yes	180 - 200	45 - 60	5 3 1   
Vols-au-vents / puff pastry crackers		-	190 - 200	20 - 30	3 
		-	180 - 190	20 - 40	4 2  
		-	180 - 190	20 - 40	5 3 1   
Lasagne / baked pasta / cannelloni / flans		Yes	190 - 200	45 - 65	2 

FUNCTIONS							
	Conventional	Grill	Gratin	Pizza	Multilevel	XL cooking	Eco Forced Air
ACCESSORIES							
	Wire shelf	Baking dish or cake tin on the wire shelf	Baking tray/Drip tray or Baking dish or cake tin on the wire shelf	Baking tray	Baking tray with 200 ml of water		

RECIPE	FUNCTION	PREHEATING	TEMPERATURE (°C)	DURATION (MIN)	LEVEL AND ACCESSORIES
Lamb / veal / beef / pork 1 kg		Yes	190 - 200	80 - 110	3
Roast pork with crackling 2 kg		Yes	180 - 190	110 - 150	2
Chicken/rabbit/duck 1 kg		Yes	200 - 230	50 - 100	2
Turkey / goose 3 kg		-	190 - 200	100 - 160	2
Baked fish / en papillote (fillets, whole)		Yes	170 - 190	30 - 50	2
Stuffed vegetables (tomatoes, courgettes, aubergines)		Yes	180 - 200	50 - 70	2
Toasted bread		-	250	2 - 6	5
Fish fillets/slices		-	230 - 250	20 - 30*	4 3
Sausages / kebabs / spare ribs / hamburgers		-	250	15 - 30*	5 4
Roast chicken 1-1,3 kg		Yes	200 - 220	55 - 70**	2 1
Roast beef rare 1 kg		Yes	200 - 210	35 - 50**	3
Leg of lamb / knuckle		Yes	200 - 210	60 - 90**	3
Roast potatoes		Yes	200 - 210	35 - 55**	3
Vegetable gratin		-	200 - 210	25 - 55	3
Meat and potatoes		Yes	190 - 200	45 - 100***	4 1
Fish and vegetables		Yes	180	30 - 50***	4 1
Lasagne and meat		Yes	200	50 - 100***	4 1
Complete meal: fruit tart (level 5) / lasagne (level 3) / meat (level 1)		Yes	180 - 190	40 - 120***	5 3 1
Roast meat/stuffed roasting joints		-	170 - 180	100 - 150	2

The time indicated does not include the preheating phase: we recommend placing the food in the oven and setting the cooking time only after the required temperature has been reached.

* Turn food halfway through cooking.

** Turn food two thirds of the way through cooking (if necessary).

*** Estimated length of time: dishes can be removed from the oven at different times depending on personal preference.

Download the Use and Care Guide from docs.indesit.eu for the table of tested recipes, compiled for the certification authorities in accordance with the standard IEC 60350-1.

FUNCTIONS							
	Conventional	Grill	Gratin	Pizza	Multilevel	XL cooking	Eco Forced Air
ACCESSORIES							
	Wire shelf	Baking dish or cake tin on the wire shelf	Baking tray or cake tin on the wire shelf	Baking tray	Baking tray with 200 ml of water		

MAINTENANCE AND CLEANING



Download the Use and Care Guide from
docs.indesit.eu for more information

Do not use steam cleaning equipment.

Use protective gloves during all operations.

Carry out the required operations with the oven cold.

Disconnect the appliance from the power supply.

Do not use wire wool, abrasive scourers or abrasive/corrosive cleaning agents, as these could damage the surfaces of the appliance.

EXTERIOR SURFACES

Clean the surfaces with a damp microfibre cloth. If they are very dirty, add a few drops of pH-neutral detergent. Finish off with a dry cloth. Do not use corrosive or abrasive detergents. If any of these products inadvertently comes into contact with the surfaces of the appliance, clean immediately with a damp microfibre cloth.

INTERIOR SURFACES

• After every use, leave the oven to cool and then clean it, preferably while it is still warm, to remove any deposits or stains caused by food residues. To dry any condensation that has formed as a result of cooking foods with a high water content, leave the oven to cool completely and then wipe it with a cloth or sponge.

If there is stubborn dirt on the interior surfaces, we recommend running the automatic cleaning function for optimal cleaning results

- The door can be easily removed and refitted to facilitate cleaning of the glass .
- Clean the glass in the door with a suitable liquid detergent.

ACCESSORIES

Soak the accessories in a washing-up liquid solution after use, handling them with oven gloves if they are still hot. Food residues can be removed using a washing-up brush or a sponge.

REMOVING AND REFITTING THE DOOR

1. To remove the door, open it fully and lower the catches until they are in the unlock position.

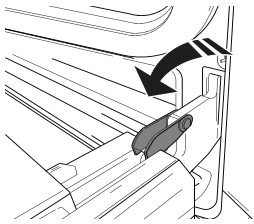

2. Close the door as much as you can. Take a firm hold of the door with both hands – do not hold it by the handle. Simply remove the door by continuing to close it while pulling it upwards (a) at the same time until it is released from its seating (b).

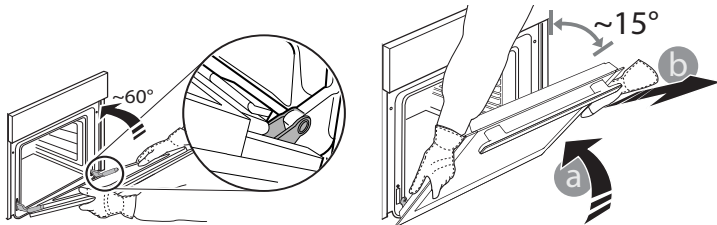

Put the door to one side, resting it on a soft surface.

3. Refit the door by moving it towards the oven, aligning the hooks of the hinges with their seating and securing the upper part onto its seating.

4. Lower the door and then open it fully. Lower the catches into their original position: make sure that you lower them down completely.

5. Try closing the door and check to make sure that it lines up with the control panel. If it does not, repeat the steps above.

CLICK & CLEAN - CLEANING THE GLASS

1. After removing the door and resting it on a soft surface with the handle downwards, simultaneously press the two retaining clips and remove the upper edge of the door by pulling it towards you.

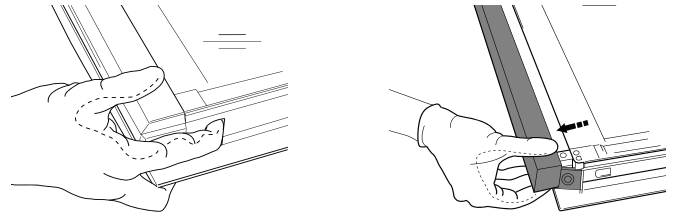

2. Lift and firmly hold the inner glass with both hands, remove it and place it on a soft surface before cleaning it.

3. Refit the intermediate pane (marked with "1R") before refitting the inside pane: To position the panes of glass correctly, make sure that the "R" mark can be seen in the left-hand corner. First insert the long side of the glass marked "R" into the support seats, then lower it into position. Repeat this procedure for both panes of glass.

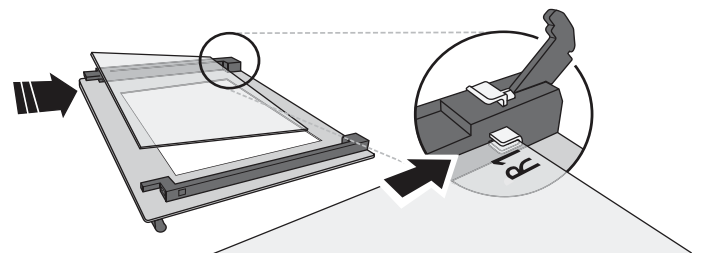

4. Refit the upper edge: a click will indicate correct positioning. Make sure the seal is secure before refitting the door.

Problem	Possible cause	Solution
The oven does not work	Power cut Disconnection from the mains	Check for the presence of mains electrical power and whether the oven is connected to the electricity supply. Turn off the oven and restart it to see if the fault persists
The display shows the letter "F" followed by a number	Software problem.	Contact you nearest After-sales Service Centre and state the letter or number that follows the letter "F"

USEFUL TIPS



Download the Use and Care Guide from docs.indesit.eu for more information

HOW TO READ THE COOKING TABLE

The table lists the best function, accessories and level to use to cook various different types of food. Cooking times start from the moment food is placed in the oven, excluding preheating (where required). Cooking temperatures and times are approximate and depend on the amount of food and the type of accessory used. Use the lowest recommended settings to begin with and, if the food is not cooked enough, then switch to higher settings. Use the accessories supplied and preferably dark-coloured metal cake tins and baking trays. You can also use Pyrex or stoneware pans and accessories, but bear in mind that cooking times will be slightly longer.

COOKING DIFFERENT FOODS AT THE SAME TIME

The "Multilevel" function enables you to cook different foods (such as fish and vegetables) on different shelves at the same time. Remove the food which requires a shorter cooking time and leave the food which requires a longer cooking time in the oven.

PRODUCT FICHE

The product fiche with energy data of this appliance can be downloaded from the website docs.indesit.eu

HOW TO OBTAIN THE USE AND CARE GUIDE

> Download the Use and Care Guide from our website docs.indesit.eu (you can use this QR Code), specifying the product's commercial code.



> Alternatively, contact our Client After-sales Service.

CONTACTING OUR AFTER-SALES SERVICE

You can find our contact details in the warranty manual. When contacting our Client After-sales Service, please state the codes provided on your product's identification plate.

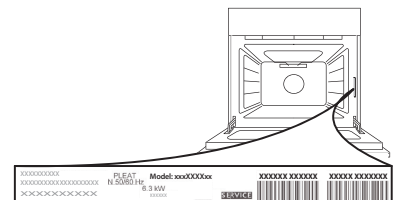

GUIDA RAPIDA



GRAZIE PER AVERE ACQUISTATO UN PRODOTTO INDESIT

Per ricevere un'assistenza più completa, registrare il prodotto su www.indesit.com/register



Scaricare le istruzioni per la sicurezza e le istruzioni per l'uso collegandosi al sito docs.indesit.eu e seguire la procedura indicata sul retro.

! Leggere attentamente le istruzioni per la sicurezza prima di utilizzare il prodotto.

DESCRIZIONE PRODOTTO

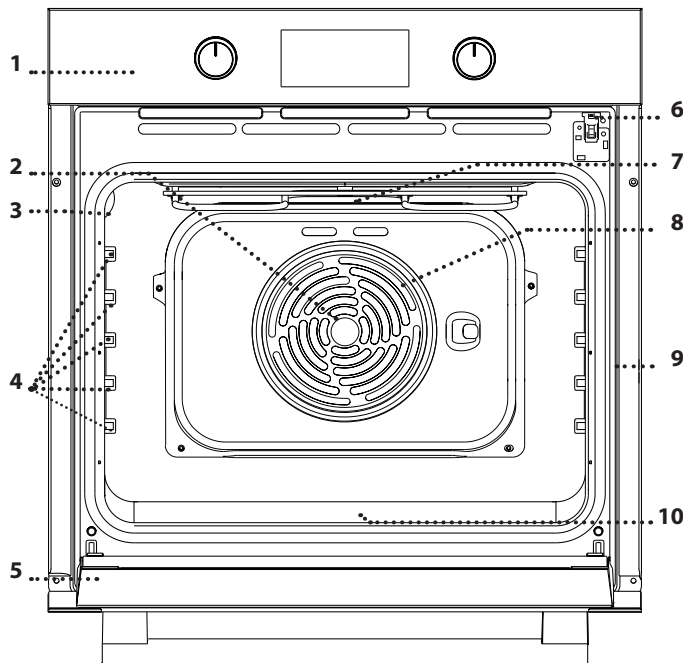

1. Pannello comandi
2. Ventola
3. Lampada
4. Griglie laterali
(il livello è indicato sulla parete della cavità)
5. Porta
6. Blocco serratura
(blocca la porta durante e dopo la pulizia automatica)
7. Resistenza superiore / grill
8. Resistenza circolare
(non visibile)
9. Targhetta matricola
(da non rimuovere)
10. Resistenza inferiore
(non visibile)

PANNELLO DI CONTROLLO

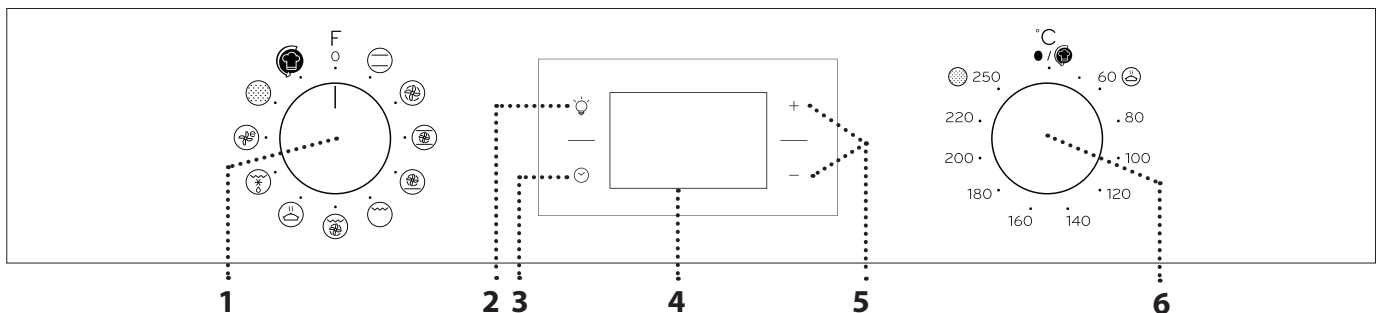

1. MANOPOLA DI SELEZIONE

Per accendere il forno selezionando una funzione. Per spegnere il forno, ruotare sulla posizione O.

2. LUCE

A forno acceso, premere per accendere o spegnere la luce di cavità del forno.

3. IMPOSTAZIONE DEL TEMPO

Per accedere alle impostazioni della durata di cottura, dell'avvio ritardato e del timer. A forno spento, per visualizzare l'ora.

4. DISPLAY

5. TASTI DI REGOLAZIONE

Per modificare le impostazioni di durata.

6. MANOPOLA TERMOSTATO

Ruotare per selezionare la temperatura desiderata attivando le funzioni manuali. Per usare la funzione "Turn & Go", tenere su .

GRIGLIA

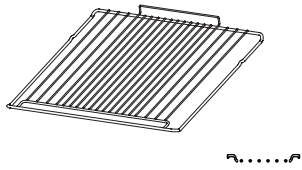

PIASTRA DOLCI

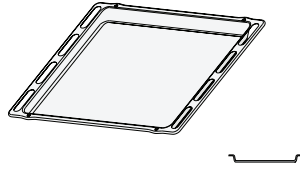

Il numero e il tipo di accessori possono variare a seconda del modello acquistato. È possibile acquistare separatamente altri accessori presso il Servizio Assistenza Clienti.

USO DEGLI ACCESSORI

• Inserire la griglia tenendola leggermente inclinata verso l'alto, appoggiando dapprima il lato posteriore rialzato - orientato verso l'alto - sul livello desiderato. In seguito, farla scivolare orizzontalmente sulla griglia laterale fino a fine corsa.

• Gli altri accessori, come la teglia, si inseriscono orizzontalmente facendoli scivolare sulle guide laterali.
• Per facilitare la pulizia del forno è possibile rimuovere le guide laterali, tirandole in modo da estrarle dalle sedi.



FUNZIONI

	STATICO Per cuocere qualsiasi tipo di pietanza su un solo ripiano.
	MULTILIVELLO Per cuocere contemporaneamente su più ripiani (massimo tre) alimenti, anche diversi, che richiedono medesima temperatura di cottura. La funzione permette di cuocere senza trasmissione di odori da un alimento all'altro.
	XL COOKING Per cuocere carni di grosse dimensioni (superiori ai 2,5 kg). Si raccomanda di girare la carne durante la cottura per farla rosolare su tutti i lati. Si consiglia inoltre di irrorare la carne di tanto in tanto per evitare che asciughi eccessivamente.
	PIZZA Per cuocere diversi tipi e formati di pizza e focaccia. Si consiglia di invertire la posizione delle teglie a metà cottura.
	GRILL Per grigliare costate, spiedini e salsicce, gratinare verdure o dorare il pane. Quando si cuoce la carne alla griglia, si consiglia di utilizzare una leccarda per raccogliere il liquido di cottura: posizionarla un livello sotto la griglia e aggiungere 200 ml di acqua potabile.
	GRATIN Per arrostiti grossi pezzi di carne (cosciotti, roast beef, polli). Si consiglia di utilizzare una leccarda per raccogliere il liquido di cottura: posizionarla un livello sotto la griglia e aggiungere 200 ml di acqua potabile.



	MANTENERE IN CALDO Per ottenere una lievitazione ottimale di impasti dolci o salati. Per preservare la qualità della lievitazione, non attivare la funzione se il forno è ancora caldo dopo un ciclo di cottura.
	FREASY COOK Vengono attivate tutte le resistenze e la ventola per garantire una distribuzione regolare e uniforme del calore in tutto il forno. Il preriscaldamento non è necessario. Questa modalità è particolarmente consigliata per cuocere rapidamente pietanze preconfezionate (surgelate o precotte). Per ottenere risultati ottimali si consiglia di usare una sola griglia.
	ECO TERMOVENTILATO Per cuocere arrostiti e arrostiti ripieni su uno stesso ripiano. La circolazione intermittente dell'aria impedisce un'eccessiva asciugatura degli alimenti. In questa funzione ECO la luce rimane spenta durante la cottura e può essere riaccesa premendo .
	PULIZIA AUTOMATICA PER PIROLISI Permette di eliminare i residui di cottura tramite un ciclo ad altissima temperatura (circa 400°).
	TURN & GO Questa funzione seleziona automaticamente la temperatura e il tempo ottimali per un'ampia varietà di ricette, tra cui carne, pesce, pasta, dolci e verdure. Attivare la funzione a forno freddo.

PRIMO UTILIZZO

1. IMPOSTARE L'ORA

Alla prima accensione, è necessario impostare l'ora: premere  finché sul display lampeggiano l'icona  e le due cifre relative all'ora.



Utilizzare + o - per impostare l'ora e premere  per confermare. Sul display lampeggiano le due cifre relative ai minuti: utilizzare + o - per impostare i minuti e premere  per confermare.

Note: quando l'icona  lampeggia, ad esempio dopo una prolungata interruzione di corrente, è necessario impostare l'ora.

2. RISCALDARE IL FORNO

Il forno è programmato per operare a una potenza inferiore a 2,9 kW ("Lo"): Perché sia compatibile con un impianto domestico di potenza superiore a 3 kW ("Hi") è necessario modificare le impostazioni. Per accedere al menu di modifica, ruotare la *manopola di selezione* su , quindi riportarla su 0

Subito dopo, premere + e - per cinque secondi.

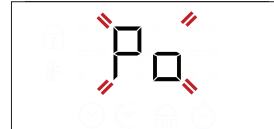

Usare + o - per cambiare l'impostazione, quindi premere  per almeno due secondi per confermare.

3. RISCALDARE IL FORNO

Un nuovo forno può rilasciare degli odori dovuti alla lavorazione di fabbrica: questo è normale. Prima di cucinare gli alimenti è dunque raccomandato di riscaldare a vuoto il forno per rimuovere ogni odore.

Rimuovere protezioni di cartone o pellicole trasparenti e togliere gli accessori dal forno.

Scaldare il forno a 250 °C per circa un'ora, utilizzando preferibilmente la funzione "XL Cooking". Durante questa procedura il forno deve essere vuoto. Seguire le istruzioni a seguire per impostare correttamente la funzione.

Nota: è opportuno ventilare la stanza durante e dopo il primo utilizzo.

USO QUOTIDIANO

1. SELEZIONARE UNA FUNZIONE

Per selezionare una funzione, ruotare la *manopola di selezione* in corrispondenza del simbolo della funzione desiderata: il display si accende e il forno emette un segnale acustico.



2. AVVIARE UNA FUNZIONE

MANUALE

Per avviare la funzione selezionata, ruotare la *manopola termostato* per impostare la temperatura desiderata.

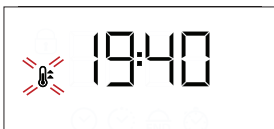

Nota: durante la cottura sarà possibile modificare la funzione ruotando la *manopola di selezione* o regolare la temperatura ruotando la *manopola termostato*.

La funzione non si avvia se la *manopola del termostato* è impostata su . Sarà possibile impostare durata, ora di fine cottura (solo se è impostata una durata) e timer.

TURN & GO

Per avviare la funzione "Turn & Go", ruotare la *manopola di selezione* sull'icona corrispondente tenendo la *manopola del termostato* sull'icona . Per terminare la cottura, ruotare la *manopola di selezione* su "0".

Note: Per ottenere risultati ottimali con la funzione "Turn & Go", seguire le indicazioni sui pesi riportate nella tabella seguente per i diversi tipi di alimenti.

Alimento	Ricetta	Peso (kg)
Carni	Arrosto di vitello, roastbeef al sangue	0,6 - 0,7
	Pollo / Cosciotto d'agnello in pezzi	1,0 - 1,2
Pesce	Filetto di salmone / Pesce al forno (intero)	0,9 - 1,0
	Pesce al cartoccio	0,8 - 1,0
Verdure	Verdure ripiene	1,8 - 2,5
	Torta alle verdure	1,5 - 2,5
Torte salate	Quiche Lorraine / Sformati	1,0 - 1,5
Pasta	Lasagne / Timballi di pasta o riso	1,5 - 2,0
Torte	Torte lievitate / Plum cake	0,9 - 1,2
	Mele al forno	1,0 - 1,5
Pane	Pagnotta	0,5 - 0,6
	Baguette	0,5 - 0,8

3. PRERISCALDAMENTO

Una volta avviata la funzione, un segnale acustico e l'icona  lampeggiante sul display segnalano che si è attivata la fase di preriscaldamento.

Al termine di questa fase, un segnale acustico e l'icona  fissa sul display indicheranno che il forno ha raggiunto la temperatura impostata: a questo punto, inserire gli alimenti e procedere alla cottura.

Note: inserire gli alimenti nel forno prima della fine del preriscaldamento può compromettere i risultati di cottura.

. PROGRAMMARE LA COTTURA

Per programmare la cottura è necessario aver selezionato precedentemente una funzione.



DURATA

Premere  tante volte fino a che sul display lampeggiano l'icona  e "00:00".





Utilizzare $+$ o $-$ per impostare la durata desiderata, quindi premere  per confermare.

Attivare la funzione ruotando la *manopola termostato* in corrispondenza della temperatura desiderata o necessaria: un segnale acustico e il display avviseranno del termine della cottura.

Note: per annullare la durata impostata, premere  tante volte fino a che sul display lampeggia l'icona  quindi utilizzare $-$ per riportare la durata a "00:00". La durata impostata include la fase di preriscaldamento.

PROGRAMMARE L'ORA DI FINE COTTURA / AVVIO RITARDATO

Una volta impostata una durata sarà possibile posticipare l'avvio della funzione, programmandone l'ora di fine: premere  fino a che sul display non lampeggiano l'icona  e l'ora corrente.



Utilizzare $+$ o $-$ per impostare l'ora di fine cottura desiderata e premere  per confermare.

Attivare la funzione ruotando la *manopola termostato* in corrispondenza della temperatura desiderata o necessaria: la funzione resterà in pausa fino ad avviarsi automaticamente dopo un periodo di tempo calcolato per terminare la cottura all'orario impostato.

Note: per annullare l'impostazione, spegnere il forno ruotando la *manopola di selezione* sulla posizione **0**.

Note: Il ritardo di avvio della funzionalità non è disponibile per le funzioni Grill e Turbo Grill.

FINE COTTURA

Un segnale acustico e il display avvisano del termine della funzione.





Ruotare la *manopola di selezione* per selezionare una funzione differente o sulla posizione "0" per spegnere il forno.

Nota: se attivo il timer, il display mostrerà la scritta "END" in alternanza al tempo rimanente.

. IMPOSTARE IL TIMER



Questa opzione non interrompe né programma la cottura ma permette di utilizzare il display come contaminuti, sia durante una funzione attiva che quando il forno è spento.

Premere ripetutamente  finché sul display lampeggiano l'icona  e "00:00".



Utilizzare $+$ o $-$ per impostare la durata desiderata e premere  per confermare.

Un segnale acustico avviserà del termine del conto alla rovescia.

Note: per disattivare il timer, premere  tante volte fino a che l'icona  lampeggia, quindi utilizzare $-$ per riportare la durata a "00:00".

. FUNZIONE DI PULIZIA AUTOMATICA PER PIROLISI

Non toccare il forno durante il ciclo di pirolisi.

Tenere i bambini e gli animali lontani dal forno durante e dopo (fino a una completa areazione della stanza) il ciclo di pirolisi.



































































Prima di attivare la funzione rimuovere tutti gli accessori dal forno, comprese le guide laterali. Se il forno è installato sotto un piano di cottura, accertarsi che durante il ciclo di pulizia automatica i bruciatori o le piastre elettriche siano spente.













Per ottenere risultati di pulizia ottimali, eliminare i depositi di grandi dimensioni con una spugna umida prima di avviare la funzione di pirolisi. Si consiglia di attivare la funzione di pirolisi soltanto se l'apparecchio è molto sporco o emana cattivi odori durante la cottura.

Per attivare la funzione di pulizia automatica, ruotare la *manopola di selezione* e la *manopola del termostato* sull'icona . La funzione si attiverà automaticamente, la porta sarà bloccata e la luce interna del forno sarà spenta: il display mostrerà il tempo rimanente, alternato alla scritta "Pyro".

A ciclo ultimato, la porta rimane bloccata fino a quando non viene raggiunta una temperatura sicura. Ventilare la stanza durante e dopo il ciclo di pirolisi.

TABELLA DI COTTURA

RICETTA	FUNZIONE	PRERISCALDAMENTO	TEMPERATURA (°C)	DURATA (MIN)	LIVELLO E ACCESSORI
Torte a lievitazione		Sì	160 - 180	30 - 90	2/3 
		Sì	160 - 180	30 - 90	4 1  
Torte ripiene (cheese cake, strudel, torta di frutta)		Sì	160 - 200	35 - 90	2 
		Sì	160 - 200	40 - 90	4 2  
Biscotti/Tortine		Sì	160 - 180	20 - 45	3 
		Sì	150 - 170	20 - 45	4 2  
		Sì	150 - 170	20 - 45	5 3 1   
Bigné		Sì	180 - 210	30 - 40	3 
		Sì	180 - 200	35 - 45	4 2  
		Sì	180 - 200	35 - 45	5 3 1   
Meringhe		Sì	90	150 - 200	3 
		Sì	90	140 - 200	4 2  
		Sì	90	140 - 200	5 3 1   
Pizza / Focaccia		Sì	190 - 250	15 - 50	1 / 2 
		Sì	190 - 250	20 - 50	4 2  
Pizze surgelate		Sì	250	10 - 20	3 
		Sì	230 - 250	10 - 25	4 2  
Torte salate (torta di verdura, quiche)		Sì	180 - 200	40 - 55	3 
		Sì	180 - 200	45 - 60	4 2  
		Sì	180 - 200	45 - 60	5 3 1   
Vol-au-vent / Salatini di pasta sfoglia		-	190 - 200	20 - 30	3 
		-	180 - 190	20 - 40	4 2  
		-	180 - 190	20 - 40	5 3 1   
Lasagne / Pasta al forno / Cannelloni / Sformati		Sì	190 - 200	45 - 65	2 

FUNZIONI	 Statico	 Grill	 Gratin	 Pizza	 Multilivello	 XL cooking	 Eco Termoventilato
ACCESSORI	 Griglia	 Teglia o tortiera su griglia	 Teglia / leccarda o pirofila o tortiera su griglia	 Piastra dolci	 Piastra dolci con 200ml di acqua		

RICETTA	FUNZIONE	PRERISCALDAMENTO	TEMPERATURA (°C)	DURATA (MIN)	LIVELLO E ACCESSORI
Agnello / Vitello / Manzo / Maiale 1 Kg		Sì	190 - 200	80 - 110	3
Arrosto di maiale con cotenna 2kg		Sì	180 - 190	110 - 150	2
Pollo / Coniglio / Anatra 1 kg		Sì	200 - 230	50 - 100	2
Tacchino / Oca 3 kg		-	190 - 200	100 - 160	2
Pesce al forno / al cartoccio (filetti, intero)		Sì	170 - 190	30 - 50	2
Verdure ripiene (pomodori, zucchine, melanzane)		Sì	180 - 200	50 - 70	2
Pane tostato		-	250	2 - 6	5
Filetti / tranci di pesce		-	230 - 250	20 - 30*	4 3
Salsicce / Spiedini / Costine / Hamburger		-	250	15 - 30*	5 4
Pollo arrosto 1-1,3 kg		Sì	200 - 220	55 - 70**	2 1
Roast beef al sangue 1 kg		Sì	200 - 210	35 - 50**	3
Cosciotto di agnello / Stinchi		Sì	200 - 210	60 - 90**	3
Patate arrosto		Sì	200 - 210	35 - 55**	3
Verdure gratinate		-	200 - 210	25 - 55	3
Carne & Patate		Sì	190 - 200	45 - 100***	4 1
Pesce & Verdure		Sì	180	30 - 50***	4 1
Lasagna & Carne		Sì	200	50 - 100***	4 1
Pasto completo: Crostata (Liv. 5) / Lasagne (Liv. 3) / Carne (Liv. 1)		Sì	180 - 190	40 - 120***	5 3 1
Arrosti / Arrosti ripieni		-	170 - 180	100 - 150	2

La durata indicata non comprende la fase di preriscaldamento: si consiglia di inserire gli alimenti nel forno e di impostare la durata della cottura solo al raggiungimento della temperatura desiderata.

* Ruotare il cibo a metà cottura.

** Ruotare il cibo a due terzi di cottura se necessario.

*** La durata è approssimata: le pietanze possono essere tolte dal forno in tempi differenti secondo preferenza.

Scaricare le Istruzioni per l'uso dal sito docs.indesit.eu per consultare la tabella delle ricette testate, compilata per gli istituti di valutazione secondo la norma CEI 60350-1.

FUNZIONI	Statico	Grill	Gratin	Pizza	Multilivello	XL cooking	Eco Termoventilato
ACCESSORI	Griglia	Teglia o tortiera su griglia	Teglia o pirofila o tortiera su griglia	Piastra dolci	Piastra dolci con 200ml di acqua		

MANUTENZIONE E PULIZIA



Per maggiori informazioni, scaricare le istruzioni per l'uso da docs.indesit.eu

Non usare pulitrici a getto di vapore.

Utilizzare guanti protettivi durante tutte le operazioni.

Eseguire le operazioni indicate a forno freddo.

Scollegare l'apparecchio dalla rete elettrica.

Non usare pagliette metalliche, panni abrasivi e detergenti abrasivi o corrosivi che possano danneggiare le superfici.

SUPERFICI ESTERNE

Pulire le superfici con un panno in microfibra umido. Se molto sporche, aggiungere qualche goccia di detergente neutro. Asciugare con un panno asciutto. Non usare detergenti corrosivi o abrasivi. Se inavvertitamente uno di questi prodotti dovesse venire a contatto con le superfici, pulire subito con un panno in microfibra umido.

SUPERFICI INTERNE

• Dopo ogni uso, lasciare raffreddare il forno e pulirlo preferibilmente quando è ancora tiepido per rimuovere incrostazioni e macchie dovute a residui di cibo; per asciugare la condensa dovuta alla cottura di alimenti ad alto contenuto di acqua, usare a forno freddo un panno o una spugna.

In caso di sporco tenace sulle superfici interne, si raccomanda di utilizzare la funzione di pulizia automatica.

- Per facilitare la pulizia dei vetri è possibile rimuovere e smontare facilmente la porta .
- Pulire i vetri della porta con detergenti liquidi specifici.

ACCESSORI

Mettere a bagno gli accessori con detersivo per piatti dopo l'uso, maneggiandoli con guanti da forno, se ancora caldi. I residui di cibo possono essere rimossi con una spazzola per piatti o con una spugna.

TOGLIERE E RIMONTARE LA PORTA

1. Per rimuovere la porta, aprirla completamente e abbassare i fermi fino alla posizione di sblocco.

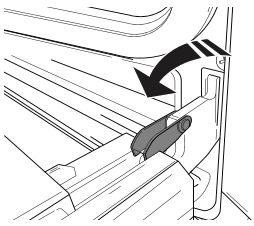

2. Chiudere la porta fino a quando è possibile. Prendere saldamente la porta con entrambe le mani, evitando di tenerla per la maniglia. Per estrarla facilmente, continuare a chiuderla e contemporaneamente tirarla verso l'alto (a) finché non esce dalle sedi (b).

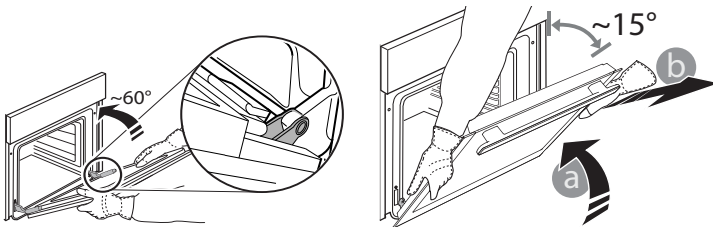

Togliere la porta e appoggiarla su un piano morbido.

3. Per rimontare la porta, avvicinarla al forno allineando i ganci delle cerniere alle proprie sedi e ancorare la parte superiore agli alloggiamenti.

4. Abbassare la porta e poi aprirla completamente. Abbassare i fermi nella posizione originale: fare attenzione che siano completamente abbassati.

5. Provare a chiudere la porta, verificando che sia allineata al pannello di controllo. Se non lo fosse, ripetere tutte le operazioni.

CLICK & CLEAN - PULIRE IL VETRO

1. Dopo aver smontato la porta e averla appoggiata su un ripiano morbido con la maniglia verso il basso, premere contemporaneamente le due clip di fissaggio ed estrarre il profilo superiore della porta tirandolo verso di sé.

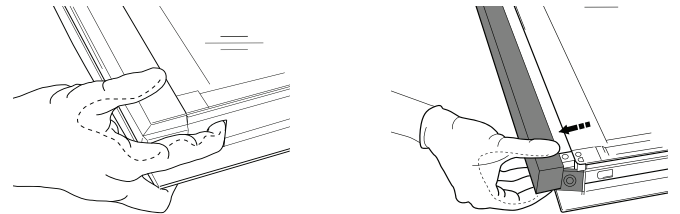

2. Sollevare e prendere saldamente il vetro interno con due mani, rimuoverlo e appoggiarlo su un piano morbido prima di eseguire la pulizia.

3. Prima di rimontare il vetro interno è necessario riapplicare il vetro intermedio (contrassegnato con "1R"). Per posizionare correttamente i vetri, verificare che la marcatura "R" sia visibile nell'angolo sinistro. Inserire dapprima il lato lungo del vetro contrassegnato con "R" nelle sedi di sostegno, quindi abbassarlo in posizione. Ripetere la procedura per entrambi i vetri.

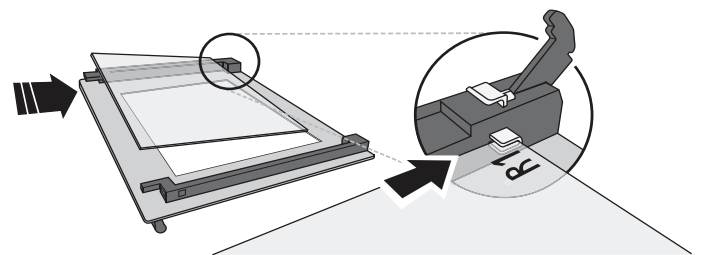

4. Rimontare il profilo superiore: un clic indica il corretto posizionamento. Verificare che la tenuta sia salda prima di rimontare la porta.

RISOLUZIONE DEI PROBLEMI



Per maggiori informazioni, scaricare
le istruzioni per l'uso da docs.indesit.eu

Problema	Possibile causa	Soluzione
Il forno non funziona	Interruzione di corrente elettrica Disconnessione dalla rete principale	Verificare che ci sia tensione in rete e che il forno sia collegato all'alimentazione elettrica. Spegnerne e riaccenderne il forno e verificare se l'inconveniente persiste
Il display mostra la lettera "F" seguita da un numero	Problema software.	Contattare il più vicino Servizio Assistenza Clienti e specificare il numero che segue la lettera "F"

CONSIGLI UTILI



Per maggiori informazioni, scaricare
le istruzioni per l'uso da docs.indesit.eu

COME LEGGERE LA TABELLA DI COTTURA

La tabella indica la funzione, gli accessori e il livello migliore da utilizzare per cuocere svariati tipi di cibo. I tempi di cottura si riferiscono all'introduzione del cibo nel forno, escluso il preriscaldamento (dove richiesto).

Le temperature e i tempi di cottura sono indicativi e dipendono dalla quantità di cibo e dal tipo di accessori. Utilizzare inizialmente i valori più bassi consigliati e, se il risultato della cottura non è quello desiderato, passare a quelli più alti. Si consiglia di utilizzare gli accessori in dotazione e tortiere o teglie possibilmente in metallo scuro. È possibile utilizzare anche pentole e accessori in pyrex o in ceramica, i tempi di cottura si allungheranno leggermente.

CUCINARE DIFFERENTI ALIMENTI CONTEMPORANEAMENTE

Utilizzando la funzione "Multilivello" è possibile cuocere contemporaneamente alimenti diversi (ad esempio: pesce e verdure) su ripiani diversi. Estrarre i cibi che richiedono tempi di cottura inferiori e lasciare continuare la cottura per quelli con tempi più lunghi.

SCHEDA TECNICA

La scheda del prodotto comprensiva dei dati energetici di questo forno può essere scaricata dal sito internet docs.indesit.eu

COME OTTENERE LE ISTRUZIONI PER L'USO

> Scaricare le Istruzioni per l'uso dal sito web docs.indesit.eu (è possibile utilizzare questo codice QR) specificando il codice prodotto.



> In alternativa, contattare il Servizio di Assistenza Clienti.

CONTATTARE IL SERVIZIO ASSISTENZA CLIENTI

I contatti possono essere trovati sul manuale di garanzia. Quando si contatta il Servizio Assistenza fornire i codici presenti sulla targhetta matricola del prodotto.

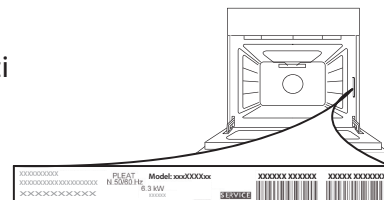

GUIDE D'UTILISATION QUOTIDIENNE



MERCI D'AVOIR ACHETER UN PRODUIT INDESIT

Afin de recevoir un service et un support complet, merci d'enregistrer votre appareil sur www.indesit.com/register



Vous pouvez télécharger les Consignes de sécurité et le Guide d'utilisation et entretien en visitant notre site Web docs.indesit.eu et en suivant les consignes au dos de ce livret.

! Lire attentivement les Consignes de santé et de sécurité avant d'utiliser l'appareil.

DESCRIPTION DU PRODUIT

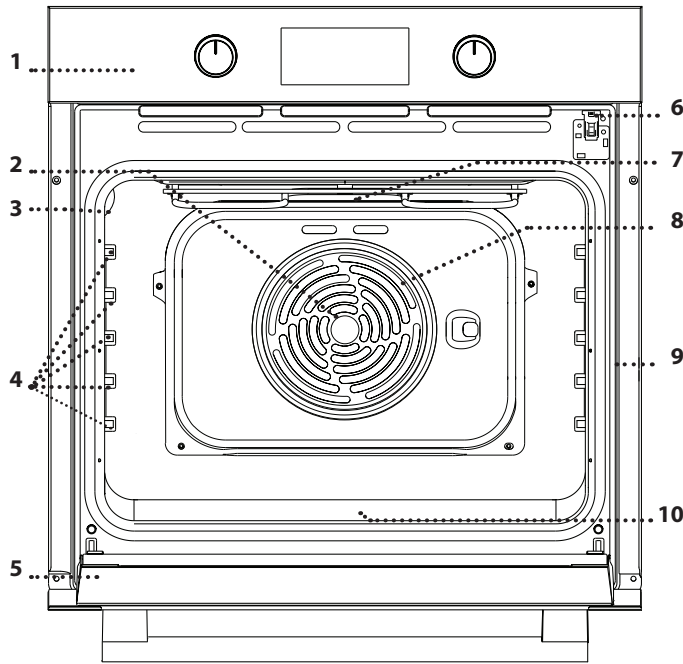

1. Panneau de commande
2. Ventilateur
3. Lampe
4. Supports de grille
(le niveau est indiqué sur la paroi du compartiment de cuisson)
5. Porte
6. Verrou de la porte
(verrouille la porte lorsque le nettoyage automatique est en cours et après)
7. Élément chauffant supérieur/gril
8. Élément chauffant rond
(invisible)
9. Plaque signalétique
(ne pas enlever)
10. Élément chauffant inférieur
(invisible)

PANNEAU DE COMMANDES

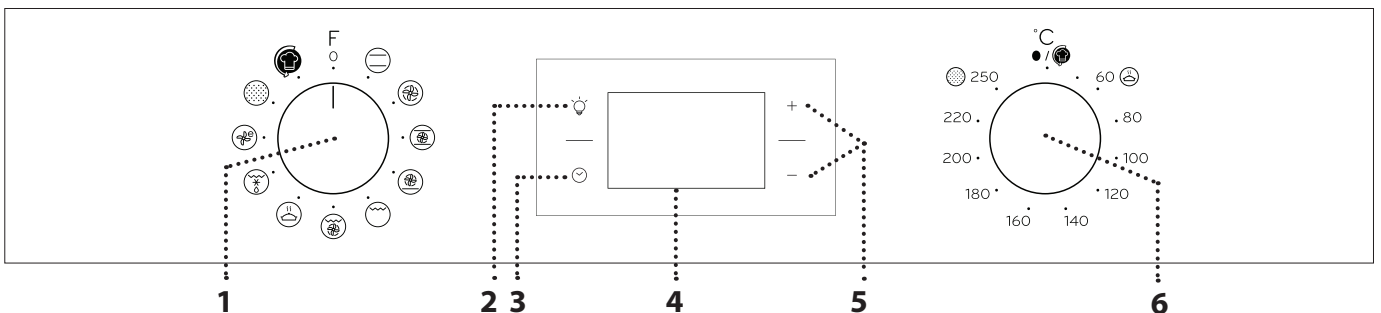

1. BOUTON DE SÉLECTION

Pour allumer le four en sélectionnant une fonction. Tournez à la position **O** pour éteindre le four.

2. ÉCLAIRAGE

Avec le four allumé, appuyez pour allumer ou éteindre l'ampoule du compartiment du four.

3. RÉGLAGE DE L'HEURE

Pour accéder les réglages pour le temps de cuisson, le départ différé, et la minuterie. Pour afficher l'heure lorsque le four est éteint.

4. ÉCRAN

5. BOUTONS DE RÉGLAGES

Pour changer les réglages du temps de cuisson.

6. BOUTON THERMOSTAT

Tournez pour sélectionner la température désirée lorsque vous utilisez les fonctions manuelles. Pour la fonction « Turn & Go », gardez **●/☉** allumé.

GRILLE MÉTALLIQUE

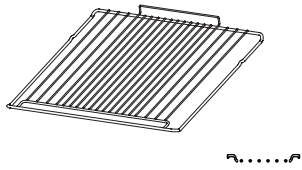

PLAQUE DE CUISSON

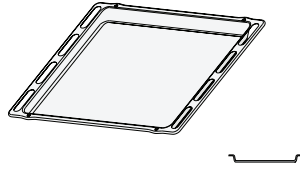

Le nombre et type d'accessoires peuvent varier selon le modèle acheté. Il est possible d'acheter séparément d'autres accessoires auprès du Service Après-Vente.

UTILISER LES ACCESSOIRES

• Insérez la grille métallique au niveau désiré en l'inclinant légèrement vers le haut et en déposant le côté arrière soulevé (pointant vers le haut) en premier. Glissez-la ensuite horizontalement sur le support de grille aussi loin que possible.

• Les autres accessoires, comme la plaque de cuisson, sont insérés horizontalement en les glissant le long des supports de grille.
• Les supports de grille peuvent être enlevés pour faciliter le nettoyage du four : tirez pour les enlever de leurs appuis.

FONCTIONS

CONVECTION NATURELLE
Pour cuire tout type de plat sur une seule grille.

MULTI-NIVEAU
Pour cuire différents aliments demandant la même température de cuisson sur plusieurs grilles (maximum de trois) en même temps. Cette fonction permet de cuire différents aliments sans transmettre les odeurs d'un aliment à l'autre.

XL COOKING
Pour cuire de gros morceaux de viande (supérieurs à 2,5 kg). Nous vous conseillons de retourner la viande durant la cuisson pour s'assurer que les deux côtés brunissent de façon égale. Nous vous conseillons d'arroser le rôti de temps en temps pour éviter qu'il ne s'assèche.

PIZZA
Pour cuire différents types et tailles de pain et de pizza. Nous vous conseillons d'échanger la position des plaques de cuisson à la mi-cuisson.

GRILL
Pour cuire des biftecks, des brochettes, et des saucisses, faire gratiner des légumes et griller du pain. Pour la cuisson de la viande, nous vous conseillons d'utiliser une plaque de cuisson pour recueillir les jus de cuisson : Placez la lèchefrite, contenant 200 ml d'eau, sur n'importe quel niveau sous la grille métallique.

GRATIN
Pour griller de gros morceaux de viande (gigots, rôtis, poulets). Nous vous conseillons d'utiliser une lèchefrite pour recueillir les jus de cuisson : Placez la lèchefrite, contenant 200 ml d'eau, sur n'importe quel niveau sous la grille métallique.

MAINTIEN AU CHAUD
Pour obtenir une meilleure fermentation des pâtes sucrées ou salées. Pour assurer la qualité de levage, n'activez pas la fonction si le four est encore chaud après un cycle de cuisson.

FREASY COOK
Tous les éléments chauffants et le ventilateur s'allument, permettant une distribution constante et uniforme de la chaleur dans le four. Il n'est pas nécessaire de préchauffer le four pour ce mode de cuisson. Ce mode est particulièrement utile pour la cuisson plus rapide de repas pré-emballés (surgelé ou pré-cuit). Vous obtenez de meilleurs résultats si vous utilisez une seule grille.



ÉCO CHALEUR PULSÉE
Pour cuire les rôtis farcis et les rôtis sur une seule grille. Les aliments ne s'assèchent pas trop grâce à une légère circulation d'air intermittente. Lorsque vous utilisez la fonction ÉCO, le voyant reste éteint durant la cuisson, mais peut être rallumé temporairement en appuyant sur .

NETTOYAGE AUTOMATIQUE DU FOUR - PYRO
Pour éliminer les éclaboussures de la cuisson en utilisant un cycle à très haute température.



TURN & GO
Cette fonction sélectionne automatiquement la température et le temps idéals pour la cuisson d'une grande variété de recettes, incluant la viande, le poisson, les pâtes, les desserts, et les légumes. Activez la fonction lorsque le four est froid.

UTILISER L'APPAREIL POUR LA PREMIÈRE FOIS

1. RÉGLAGE DE L'HEURE

Vous devez régler l'heure lorsque vous allumez l'appareil pour la première fois : Appuyez sur  jusqu'à ce que le voyant  et les deux chiffres indiquant l'heure clignotent à l'écran.



Utilisez + ou - pour régler l'heure et appuyez sur  pour confirmer. Les deux chiffres des minutes clignotent. Utilisez + ou - pour régler les minutes et appuyez sur  pour confirmer.

Veillez noter : Lorsque le voyant  clignote (par exemple après des pannes de courant prolongées), vous devrez régler l'heure de nouveau.

2. CHAUFFER LE FOUR

Le four est programmé pour fonctionner avec une puissance inférieure à 2,9 kW (« Lo ») : Pour utiliser le four avec une puissance compatible avec un réseau électrique domestique supérieur à 3 kW (« Hi »), vous devez changer les réglages.

Pour aller au menu de réglage, tournez le *bouton de sélection* sur , retournez-le ensuite sur 0

Appuyez sur + et - pour cinq secondes immédiatement après.

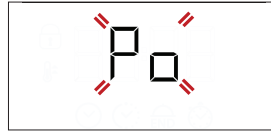

Utilisez + ou - pour changer le réglage, appuyez ensuite sur  pour au moins deux secondes pour confirmer.

3. CHAUFFER LE FOUR

Un nouveau four peut dégager des odeurs provenant de la fabrication : ceci est parfaitement normal. Avant de cuire des aliments, nous vous conseillons de chauffer le four à vide pour éliminer les odeurs. Enlevez les cartons de protection ou les pellicules transparentes du four, et enlevez les accessoires qui se trouvent à l'intérieur.

Chauffez le four à 250 °C pour environ une heure, de préférence en utilisant la fonction « XL Cooking ». Le four doit être vide durant cette opération. Suivez les directives pour régler correctement la fonction.

Veillez noter : Nous vous conseillons d'aérer la pièce après avoir utilisé l'appareil pour la première fois.

UTILISATION QUOTIDIENNE

1. SÉLECTIONNER UNE FONCTION

Pour sélectionner une fonction, tournez le *bouton de sélection* sur le symbole de la fonction désirée : l'écran s'illumine et un signal sonore se fait entendre.



2. ACTIVER UNE FONCTION

MANUEL

Pour lancer la fonction que vous avez sélectionnée, tournez le *bouton du thermostat* pour régler la température requise.



Veillez noter : Lors de la cuisson, vous pouvez changer la fonction en tournant le *bouton de sélection* ou ajuster la température en tournant le *bouton du thermostat*. La fonction ne démarre pas tant que le *bouton du thermostat* est sur . Vous pouvez régler le temps de cuisson, le temps de fin de cuisson (seulement si vous réglez le temps de cuisson) et la minuterie.

TURN & GO



Pour démarrer la fonction « Turn & Go », sélectionner la fonction en tournant le *bouton de sélection* pour l'icône correspondant en maintenant le *bouton du thermostat* sur l'icône .

Pour interrompre la cuisson, tournez le *bouton de sélection* sur « 0 ».

Veillez noter : Pour obtenir les meilleurs résultats avec la fonction « Turn & Go », observez les poids suggérés pour chaque type d'aliments dans le tableau suivant.

Aliments	Recette	Poids (kg)
Viandes	Rôti d'agneau, rôti de boeuf saignant	0,6 - 0,7
	Poulet / gigot d'agneau en morceaux	1,0 - 1,2
Poisson	Filet de saumon / poisson au four (entier)	0,9 - 1,0
	Poisson en papillote	0,8 - 1,0
Légumes	Légumes farcis	1,8 - 2,5
	Tarte aux légumes	1,5 - 2,5
Quiches et tartes salées	Quiche lorraine / Tarte	1,0 - 1,5
Pâtes	Lasagne / Timbale de pâtes ou de riz	1,5 - 2,0
Gâteaux	Gâteau à la levure / gâteau aux prunes	0,9 - 1,2
	Pommes au four	1,0 - 1,5
Pain	Pain (Miche)	0,5 - 0,6
	Baguettes	0,5 - 0,8

3. PRÉCHAUFFAGE ET CHALEUR RÉSIDUELLE

Une fois que la fonction est activée, un signal sonore et un voyant  qui clignote à l'écran confirmant que la phase de préchauffage est activée. À la fin de cette phase, un signal sonore et un voyant stable  indique que le four a atteint la température désirée : vous pouvez alors placer les aliments à l'intérieur et commencer la cuisson.

Veuillez noter : Placer les aliments dans le four avant la fin du préchauffage peut affecter la qualité de la cuisson.

Après la cuisson et avec la fonction désactivée, le voyant  peut rester visible sur l'écran même après que le ventilateur de refroidissement s'est éteint pour indiquer qu'il y a de la chaleur résiduelle dans le compartiment.

Veuillez noter : Le temps nécessaire pour que l'icône s'éteigne varie car cela dépend d'une série de facteurs tels que la température ambiante et la fonction utilisée. Dans tous les cas, le produit doit être considéré comme éteint lorsque le curseur sur le bouton de sélection est sur « 0 ».

4. PROGRAMMER LA CUISSON

Vous devez sélectionner une fonction avant de pouvoir lancer un programme de cuisson.

DURÉE

Appuyez sur la touche  jusqu'à ce que le voyant  et « 00:00 » clignotent à l'écran.





Utilisez $+$ ou $-$ pour régler la durée de cuisson et appuyez sur  pour confirmer.

Lancez la fonction en tournant le *bouton du thermostat* à la température désirée : un signal sonore se fait entendre et l'écran s'allume lorsque la cuisson est terminée.

Remarques : Pour annuler le temps de cuisson, appuyez sur  jusqu'à ce que le voyant  clignote sur l'écran, utilisez ensuite $-$ pour remettre le temps de cuisson à « 00:00 ». Ce temps de cuisson inclut la phase de préchauffage.

PROGRAMMER L'HEURE DE FIN DE CUISSON/ DÉPART DIFFÉRÉ

Après avoir réglé le temps de cuisson, vous pouvez retarder le début de la fonction en programmant le temps de fin de cuisson : appuyez sur  jusqu'à ce que l'icône  et l'heure actuelle clignotent à l'écran.



Utilisez $+$ ou $-$ pour régler la durée de cuisson et appuyez sur  pour confirmer.

Lancez la fonction en tournant le *bouton du thermostat* à la température désirée : la fonction reste en veille et démarre automatiquement après la période d'attente calculée pour que la cuisson se termine à l'heure désirée.

Remarques : Pour annuler le réglage, éteindre le four en tournant le *bouton de sélection* à la position 0.

Remarques : Le démarrage différé de la fonctionnalité n'est pas disponible pour les fonctions Grill et Turbo-grill.

FIN DE CUISSON

Un signal sonore se fait entendre et l'écran s'allume pour indiquer que la fonction est terminée.



Tournez le *bouton de sélection* pour sélectionner une différente fonction ou le placer à la position « 0 » pour éteindre le four.

Veuillez noter : Si la minuterie fonctionne, l'écran affiche « END » en alternance avec le temps restant.

5. RÉGLER LA MINUTERIE



Cette option n'interrompt pas ou ne programme pas la cuisson, mais permet d'utiliser l'écran comme minuterie, durant le fonctionnement d'une fonction ou quand le four est éteint.

Appuyez sur la touche  jusqu'à ce que le voyant  « 00:00 » et « 00:00 » clignotent à l'écran.



Utilisez $+$ ou $-$ pour régler l'heure désirée et appuyez sur  pour confirmer.

Un signal sonore se fait entendre lorsque la minuterie a terminé le compte à rebours.

Remarques : Pour annuler la minuterie, appuyez sur  jusqu'à ce que le voyant  clignote, utilisez ensuite $-$ pour remettre le temps à « 00:00 ».

6. FONCTION DE NETTOYAGE AUTOMATIQUE - PYRO

Ne touchez pas le four pendant le cycle de nettoyage Pyro.



































































Éloignez les enfants et les animaux du four pendant et après (le temps que la pièce soit bien aérée) le cycle de nettoyage Pyro.













Retirez tous les accessoires du four - incluant les supports de grille - avant d'activer la fonction. Si le four est installé sous une table de cuisson, assurez-vous que les brûleurs ou les plaques électriques sont éteints pendant le cycle d'auto-nettoyage. Pour des résultats de nettoyage optimaux, enlevez les résidus en excès à l'intérieur de la cavité et nettoyez la vitre de la porte intérieure avant d'utiliser la fonction Pyrolyse. age Pyro seulement si le four est très sale ou s'il dégage de mauvaises odeurs lors de la cuisson.

Pour lancer la fonction de nettoyage automatique, tournez le *bouton de sélection* et le bouton du thermostat sur l'icône . La fonction démarre automatiquement, la porte se verrouille, et l'ampoule à l'intérieur du four s'éteint : L'écran affiche le temps restant avant la fin, en alternance avec « Pyro ».

Une fois le cycle terminé, la porte reste verrouillée jusqu'à ce que la température à l'intérieur du four atteigne un niveau sécuritaire. Aérez la pièce pendant et après avoir utilisé le cycle Pyro.

TABLEAU DE CUISSON

RECETTE	FONCTION	PRÉCHAUFFAGE	TEMPÉRATURE (°C)	DURÉE (MIN)	NIVEAU ET ACCESSOIRES
Gâteaux à pâte levée		Oui	160 - 180	30 - 90	2/3 
		Oui	160 - 180	30 - 90	4 1  
Gâteau fourré (gâteau au fromage, strudel, tarte aux fruits)		Oui	160 - 200	35 - 90	2 
		Oui	160 - 200	40 - 90	4 2  
Biscuits/tartelettes		Oui	160 - 180	20 - 45	3 
		Oui	150 - 170	20 - 45	4 2  
		Oui	150 - 170	20 - 45	5 3 1   
Chouquettes		Oui	180 - 210	30 - 40	3 
		Oui	180 - 200	35 - 45	4 2  
		Oui	180 - 200	35 - 45	5 3 1   
Meringues		Oui	90	150 - 200	3 
		Oui	90	140 - 200	4 2  
		Oui	90	140 - 200	5 3 1   
Pizza/pain		Oui	190 - 250	15 - 50	1 / 2 
		Oui	190 - 250	20 - 50	4 2  
Pizza congelée		Oui	250	10 - 20	3 
		Oui	230 - 250	10 - 25	4 2  
Quiches et tartes salés (tarte aux légumes, quiche)		Oui	180 - 200	40 - 55	3 
		Oui	180 - 200	45 - 60	4 2  
		Oui	180 - 200	45 - 60	5 3 1   
Vol-au-vent / biscuits à pâte feuilletée		-	190 - 200	20 - 30	3 
		-	180 - 190	20 - 40	4 2  
		-	180 - 190	20 - 40	5 3 1   
Lasagnes / pâtes au four / cannellonis / tartes		Oui	190 - 200	45 - 65	2 

FONCTIONS	 Convection naturelle	 Grill	 Gratin	 Pizza	 Multi-niveau	 XL cooking	 Éco Chaleur pulsée
ACCESSOIRES	 Grille métallique	 Plaque de cuisson ou moule à gâteau sur la grille métallique	 Plaque de cuisson/lèche-frite, ou plat de cuisson ou moule à gâteau sur la grille métallique	 Plaque de cuisson	 Plaque de cuisson contenant 200 ml d'eau		

RECETTE	FONCTION	PRÉCHAUFFAGE	TEMPÉRATURE (°C)	DURÉE (MIN)	NIVEAU ET ACCESSOIRES
Agneau/veau/ bœuf/porc 1 kg		Oui	190 - 200	80 - 110	
Rôti de porc avec grattons 2 kg		Oui	180 - 190	110 - 150	
Poulet/lapin/canard 1 kg		Oui	200 - 230	50 - 100	
Dinde/oie 3 kg		-	190 - 200	100 - 160	
Poisson au four / en papillote (filet, entier)		Oui	170 - 190	30 - 50	
Légumes farcis (tomates, courgettes, aubergines)		Oui	180 - 200	50 - 70	
Pain grillé		-	250	2 - 6	
Filets/tranches de poisson		-	230 - 250	20 - 30*	
Saucisses/brochettes/côtes levées/hamburgers		-	250	15 - 30*	
Poulet rôti 1 - 1,3 kg		Oui	200 - 220	55 - 70**	
Rosbif saignant 1 kg		Oui	200 - 210	35 - 50**	
Gigot d'agneau/jarret		Oui	200 - 210	60 - 90**	
Pom. terre rôties		Oui	200 - 210	35 - 55**	
Gratin de légumes		-	200 - 210	25 - 55	
Viandes et pommes de terre		Oui	190 - 200	45 - 100***	
Poisson et légumes		Oui	180	30 - 50***	
Lasagnes & viande		Oui	200	50 - 100***	
Repas complet : tarte aux fruits (niveau 5)/ lasagne (niveau 3)/ viande (niveau 1)		Oui	180 - 190	40 - 120***	
Rôtis/rôtis farcis		-	170 - 180	100 - 150	

La durée de cuisson ne comprend pas la phase de préchauffage : Nous vous conseillons de placer les aliments dans le four et régler le temps de cuisson seulement après avoir atteint la température désirée.

* Tourner les aliments à mi-cuisson.

** Au besoin, retournez les aliments aux deux tiers de la cuisson).

*** Temps approximatif : les plats peuvent être retirés en tout temps, selon vos préférences personnelles.

Téléchargez le Guide d'utilisation et d'entretien sur docs.indesit.eu pour obtenir le tableau de recettes testées, compilé pour les autorités de certification, conformément à la norme CEI 60350-1.

FONCTIONS							
ACCESSOIRES							

NETTOYAGE ET ENTRETIEN



Pour plus d'information, téléchargez le Guide d'utilisation et d'entretien à partir de docs.indesit.eu

N'utilisez pas d'appareil de nettoyage à vapeur.

Utilisez des gants de protection lors des opérations.

Effectuez les opérations nécessaires lorsque le four est froid.

Débranchez l'appareil de l'alimentation électrique.

N'utilisez pas de laine d'acier, de tampons à récurer abrasifs, ou des détergents abrasifs ou corrosifs, ils pourraient endommager les surfaces de l'appareil.

SURFACES EXTÉRIEURES

Nettoyez les surfaces à l'aide d'un chiffon en microfibre humide. Si elles sont très sales, ajoutez quelques gouttes de détergent à pH neutre. Essuyez avec un chiffon sec. N'utilisez pas de détergents corrosifs ou abrasifs. Si l'un de ces produits entre en contact avec des surfaces de l'appareil, nettoyez immédiatement à l'aide d'un chiffon en microfibre humide.

SURFACES INTÉRIEURES

• Après chaque utilisation, laissez le four refroidir et nettoyez-le, de préférence lorsqu'il est encore tiède, pour enlever les dépôts ou taches laissés par les résidus de nourriture. Pour enlever la condensation qui se serait formée lors de la cuisson d'aliments avec une forte teneur en eau, laissez le four refroidir complètement et essuyez-le avec un chiffon ou une éponge.

S'il y a des taches tenaces sur les surfaces intérieures, nous vous conseillons d'utiliser la fonction de nettoyage automatique pour de meilleurs résultats de nettoyage

- La porte peut facilement être enlevée et remplacée pour faciliter le nettoyage de la vitre .
- Nettoyez le verre dans la porte avec un détergent liquide approprié.

ACCESSOIRES

Faites tremper les accessoires dans de l'eau contenant un détergent à vaisselle, utilisez des gants de cuisine s'ils sont encore chauds. Utilisez une brosse à vaisselle ou une éponge pour enlever les résidus d'aliments.

ENLEVER ET RÉINSTALLER LA PORTE

1. Pour enlever la porte, ouvrez-la complètement et abaissez les loquets jusqu'à qu'ils soient déverrouillés.

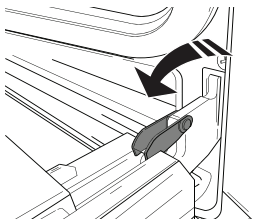

2. Fermez le plus possible la porte. Tenez la porte fermement avec les deux mains – ne la tenez pas par la poignée. Enlevez simplement la porte en continuant à la fermer tout en la tirant vers le haut (a) jusqu'à ce qu'elle soit dégagée de ses appuis (b).

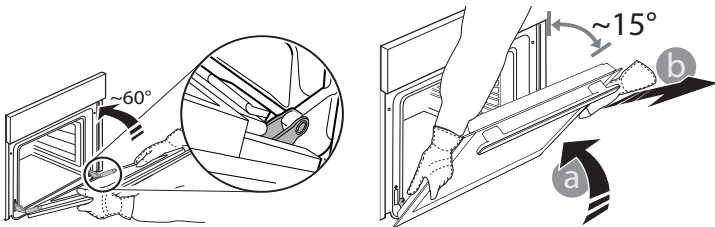

Placez la porte de côté, l'appuyant sur une surface souple.

3. Réinstallez la porte en la plaçant devant le four pour aligner les crochets des charnières avec leurs appuis et attacher la partie supérieure sur son appui.

4. Abaissez la porte pour ensuite l'ouvrir complètement. Abaissez les loquets dans leur position originale : assurez-vous de les abaisser complètement.

5. Essayez de fermer la porte et assurez-vous qu'elle est alignée avec le panneau de commande. Sinon, répétez les étapes précédentes.

CLICK & CLEAN - NETTOYER LE VERRE

1. Après avoir enlevé la porte et l'avoir placée sur une surface matelassée, les poignées vers le bas, appuyez sur les deux fermetures en même temps et enlevez le bord supérieur de la porte en la tirant vers vous.

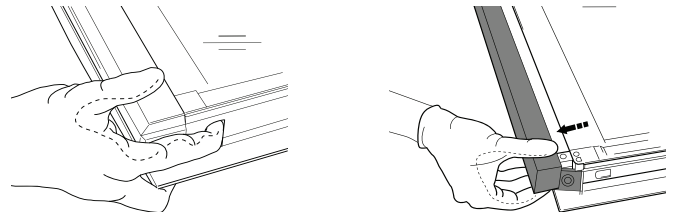

2. Soulevez et tenez fermement la vitre intérieure avec les deux mains, enlevez-la et placez-la sur une surface matelassée avant de la nettoyer.

3. Replacer le panneau du milieu (identifié par « 1R ») avant de replacer le panneau intérieur : Pour placer correctement les parois de verre, assurez-vous que la marque « R » se trouve dans le coin gauche. En premier, insérez la longue partie de la vitre marquée d'un « R » dans les appuis des guides, abaissez-la ensuite en place. Répétez cette procédure pour les deux parois de verre.

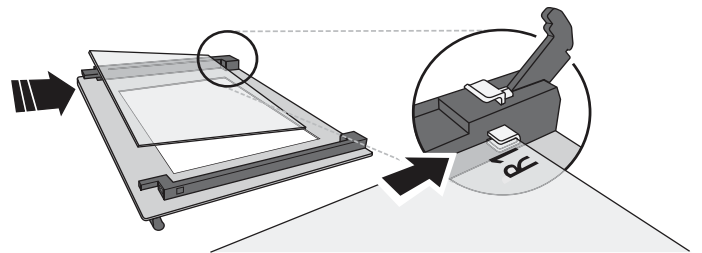

4. Remplacez le bord supérieur : un déclic indique le positionnement correct. Assurez-vous que le joint est bien placé avant de replacer la porte.

Problème	Cause possible	Solution
Le four ne fonctionne pas	Coupure de courant Débranchez de l'alimentation principale	Assurez-vous qu'il n'y a pas de panne de courant et que le four est bien branché. Éteignez puis rallumez le four pour voir si le problème persiste
L'écran affiche la lettre « F » suivi d'un numéro	Problème de logiciel.	Prenez en note la lettre ou le numéro qui suit la lettre « F » et contactez le Service Après-vente le plus près

CONSEILS UTILES



Pour plus d'information, téléchargez le Guide d'utilisation et d'entretien à partir de docs.indesit.eu

COMMENT LIRE LE TABLEAU DE CUISSON

Le tableau indique la meilleure fonction, les accessoires, et le niveau à utiliser pour la cuisson des différents types d'aliments.

Les temps de cuisson commencent au moment de l'introduction du plat dans le four et ne tiennent pas compte du préchauffage (s'il est nécessaire).

Les températures et temps de cuisson sont approximatifs et dépendent de la quantité d'aliments et du type d'accessoire. Pour commencer, utilisez les valeurs conseillées les plus basses, et si les aliments ne sont pas assez cuits, augmentez-les. Utilisez les accessoires fournis, et de préférence des moules à gâteau en métal foncés et des plats de cuisson. Vous pouvez aussi utiliser des plaques et accessoires en pyrex ou en céramique ; cependant, les temps de cuisson seront sensiblement plus longs.

CUIRE DES ALIMENTS DIFFÉRENTS EN MÊME TEMPS

La fonction « Multi-niveau » permet de cuire en même temps plusieurs aliments nécessitant la même température de cuisson (comme le poisson et les légumes) sur différentes grilles. Enlevez les aliments qui demandent moins de cuisson et laissez dans le four les aliments qui ont besoin de plus de cuisson.

FICHE TECHNIQUE

La fiche technique, incluant les taux d'efficacité énergétique du four, peut être téléchargée sur notre site Web docs.indesit.eu

COMMENT OBTENIR LE GUIDE D'UTILISATION ET ENTRETIEN

Téléchargez le Guide d'utilisation et d'entretien sur notre site Web docs.indesit.eu (vous pouvez utiliser ce code QR), en précisant le code commercial du produit.

Une autre façon est de contacter notre Service près-vente



CONTACTER LE SERVICE APRÈS-VENTE

Vous pouvez trouver les informations pour nous contacter dans le livret de garantie. Lorsque vous contactez notre Service Après-vente, veuillez indiquer les codes disponibles sur la plaque signalétique de l'appareil.

