

# DAILY REFERENCE GUIDE



## THANK YOU FOR PURCHASING AN INDESIT PRODUCT

To receive more comprehensive help and support, please register your product at [www.indesit.com/register](http://www.indesit.com/register)



You can download the Safety Instructions and the Use and Care Guide by visiting our website [docs.indesit.eu](http://docs.indesit.eu) and following the instructions on the back of this booklet.



**Before using the appliance carefully read the Health and Safety guide.**

## PRODUCT DESCRIPTION

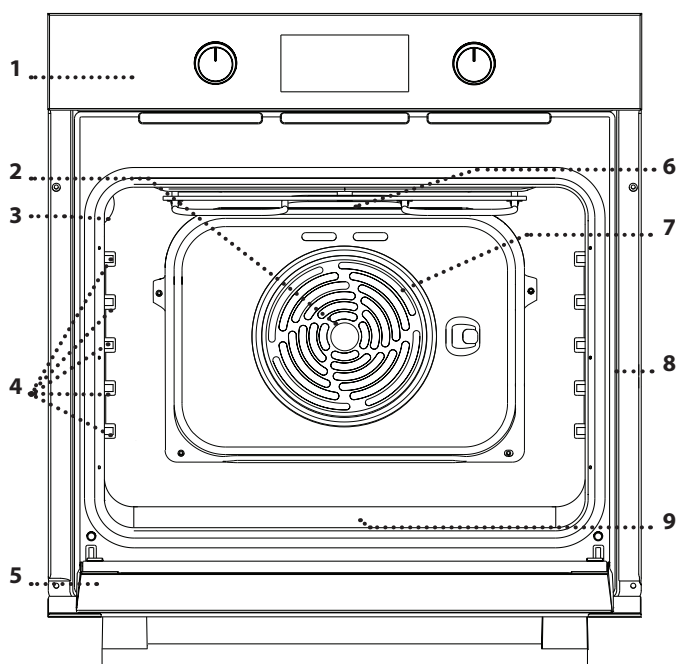

1. Control panel
2. Fan
3. Lamp
4. Shelf guides  
(the level is indicated on the wall of the cooking compartment)
5. Door
6. Upper heating element/grill
7. Circular heating element  
(non-visible)
8. Identification plate  
(do not remove)
9. Bottom heating element  
(non-visible)

## CONTROL PANEL

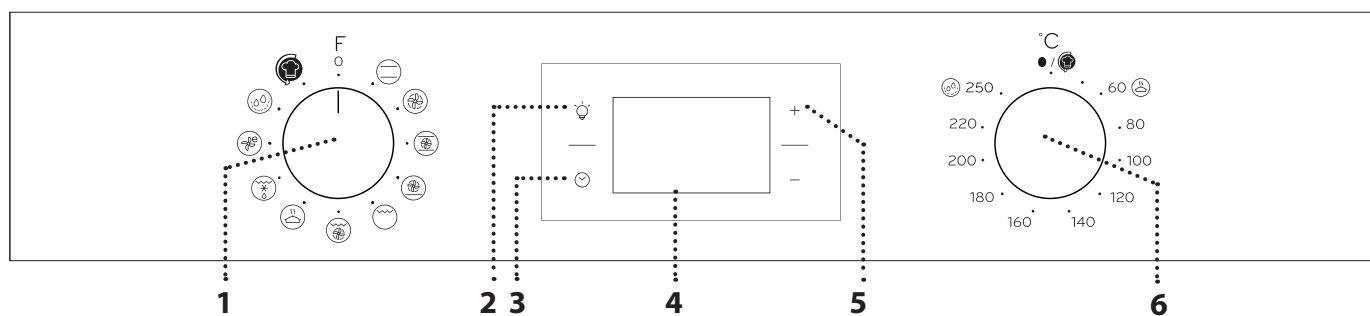

### 1. SELECTION KNOB

For switching the oven on by selecting a function. Turn to the 0 position to switch the oven off.

### 2. LIGHT

With the oven switched on, press to turn the oven compartment lamp on or off.

### 3. SETTING THE TIME

For accessing the cooking time settings, delayed start and timer. For displaying the time when the oven is off.

### 4. DISPLAY

### 5. ADJUSTMENT BUTTONS

For changing the cooking time settings.

### 6. THERMOSTAT KNOB

Turn to select the temperature you require when activating manual functions. For automatic functions use

## WIRE SHELF

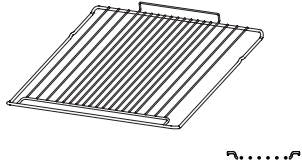

## BAKING TRAY

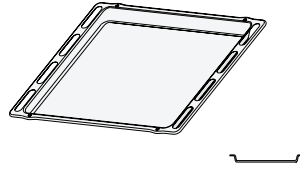

The number and the type of accessories may vary depending on which model is purchased. Other accessories can be purchased separately from the After-sales Service.

## USING THE ACCESSORIES

• Insert the wire shelf onto the level you require by holding it tilted slightly upwards and resting the raised rear side (pointing upwards) down first. Then slide it horizontally along the shelf guide as far as possible.

The other accessories, such as the baking tray, are inserted horizontally by sliding them along the shelf guides.

• The shelf guides can be removed to facilitate the oven cleaning: pull it to remove from its seats.

# FUNCTIONS

**CONVENTIONAL**  
For cooking any kind of dish on one shelf only.

**MULTILEVEL**  
For cooking different foods that require the same cooking temperature on several shelves (maximum three) at the same time. This function can be used to cook different foods without odours being transferred from one food to another.

**XL COOKING**  
For cooking large joints of meat (above 2.5 kg). We recommend turning the meat over during cooking to ensure that both sides brown evenly. We also recommend basting the joint every so often to prevent it from drying out excessively.

**PIZZA**  
For baking different types and sizes of pizza and bread. It is a good idea to swap the position of the baking trays halfway through cooking.

**GRILL**  
For grilling steaks, kebabs and sausages, cooking vegetables au gratin or toasting bread. When grilling meat, we recommend using a Baking tray to collect the cooking juices: position the pan on any of the levels below the wire shelf and add 200 ml of drinking water.

**GRATIN**  
For roasting large joints of meat (legs, roast beef, chicken). We recommend using a Baking tray to collect the cooking juices: position the pan on any of the levels below the wire shelf and add 200 ml of drinking water.

**KEEP WARM**  
For helping sweet or savoury dough to rise effectively. To maintain the quality of proving, do not activate the function if the oven is still hot following a cooking cycle.

**FREASY COOK**  
All the heating elements and the fan come on, guaranteeing the distribution of heat consistently and uniformly throughout the oven. Pre-heating is not necessary for this cooking mode. This mode is especially recommended for cooking pre-packed food quickly (frozen or pre-cooked). The best results are obtained if you use one cooking rack only.



**ECO FORCED AIR**  
For cooking roasts and stuffed roasting joints on a single shelf. Food is prevented from drying out excessively by gentle, intermittent air circulation. When this ECO function is in use, the light will remain switched off during cooking but can be switched on again by pressing .

**HYDROCLEANING**  
The action of the steam released during this special low-temperature cleaning cycle allows dirt and food residues to be removed with ease. Pour 200 ml of drinking water on the bottom of the oven and use the function for 35' at 90°C. Activate the function when the oven is cold and let it cool down for 15' once the cycle ends.



**TURN & GO**  
This function automatically selects an ideal temperature and time for baking a wide range of recipes including meat, fish, pasta, sweets and vegetables. Activate the function when the oven is cold.

# USING THE APPLIANCE FOR THE FIRST TIME

## 1. SETTING THE TIME

You will need to set the time when you switch on the appliance for the first time: Press  until the  icon and the two digits for the hour start flashing on the display.



Use + or - to set the hour and press  to confirm. The two digits for the minutes will start flashing. Use + or - to set the minutes and press  to confirm.

Please note: When the  icon is flashing, for example following lengthy power outages, you will need to reset the time.

## 2. HEAT THE OVEN

A new oven may release odours that have been left behind during manufacturing: this is completely normal.

Before starting to cook food, we therefore recommend heating the oven with it empty in order to remove any possible odours.

Remove any protective cardboard or transparent film from the oven and remove any accessories from inside it.

Heat the oven to 250 °C for about one hour, preferably using the "XL Cooking" function. The oven must be empty during this time.

Follow the instructions for setting the function correctly.

Please note: It is advisable to air the room after using the appliance for the first time.

# DAILY USE

## 1. SELECT A FUNCTION

To select a function, turn the *selection knob* to the symbol for the function you require: the display will light up and an audible signal will sound.



## 2. ACTIVATE A FUNCTION

### MANUAL

To start the function you have selected, turn the *thermostat knob* to set the temperature you require.



Please note: During cooking you can change the function by turning the *selection knob* or adjust the temperature by turning the *thermostat knob*.

The function will not start if the *thermostat knob* is on 0 °C. You can set the cooking time, cooking end time (only if you set a cooking time) and a timer.

### TURN & GO

To start the "Turn & Go" function, select the function turning the *selection knob* on the relevant icon, keeping the *thermostat knob* on the  icon. To end the cooking, turn the *selection knob* on "0".

Please note: To obtain the best cooking results using the "Turn & Go" function, follow the suggested weights for each kind of food in the following table.



Food	Recipe	Weight (kg)
Meat	Roast veal, Roast Beef rare	0,6 - 0,7
	Chicken / Leg of lamb in pieces	1,0 - 1,2
Fish	Salmon fillet / Baked fish (whole)	0,9 - 1,0
	Fish en papillote	0,8 - 1,0
Vegetables	Stuffed vegetables	1,8 - 2,5
	Vegetable pie	1,5 - 2,5
Salty cakes	Quiche lorraine / Flan	1,0 - 1,5
Pasta	Lasagne / Timbale of pasta or rice	1,5 - 2,0
Pastry	Leavened cake / Plum cake	0,9 - 1,2
	Baked apples	1,0 - 1,5
Bread	Bread loaf	0,5 - 0,6
	Baguettes	0,5 - 0,8

### KEEP WARM

To start the "Keep Warm" function, turn the *thermostat knob* to the relevant symbol; if the oven is set to a different temperature (or if the cavity temperature is above 65°C) the function will not start.

Please note: You can set the cooking time, cooking end time (only if you set a cooking time) and a timer.

### 3. PREHEATING



Once the function starts, an audible signal and a flashing icon  on the display indicate that the preheating phase has been activated. At the end of this phase, an audible signal and the fixed icon  on the display will indicate that the oven has reached the set temperature: at this point, place the food inside and proceed with cooking.

Please note: Placing the food in the oven before preheating has finished may have an adverse effect on the final cooking result.

### . PROGRAMMING COOKING

You will need to select a function before you can start programming cooking.



#### DURATION

Keep pressing  until the  icon and "00:00" start flashing on the display.



Use  $+$  or  $-$  to set the cooking time you require, then press  to confirm.

Activate the function by turning the *thermostat knob* to the temperature you require: an audible signal will sound and the display will indicate that cooking is complete.

Notes: To cancel the cooking time you have set, keep pressing  until the  icon starts flashing on the display, then use  $-$  to reset the cooking time to "00:00". This cooking time includes a preheating phase.

#### PROGRAMMING THE END COOKING TIME/ DELAYED START

After a cooking time has been set, starting the function can be delayed by programming its end time: press  until the  icon and the current time start flashing on the display.

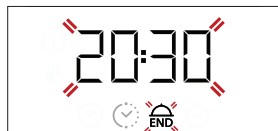

Use  $+$  or  $-$  to set the time you want cooking to end and press  to confirm.

Activate the function by turning the *thermostat knob* to the temperature you require: the function will remain paused until it starts automatically after the period of time that has been calculated in order for cooking to finish at the time you have set.

Notes: To cancel the setting, switch the oven off by turning the *selection knob* to the **0** position.

Notes: Delay to start functionality is not available for Grill and Turbo Grill functions.

### END OF COOKING

An audible signal will sound and the display will indicate that the function has finished.





Turn the *selection knob* to select a different function or to position "0" to switch the oven off.

Please note: If the timer is active, the display will show "END" alternately with the remaining time.

### . SETTING THE TIMER



This option does not interrupt or program cooking but allows you to use the display as a timer, either during while a function is active or when the oven is off.

Keep pressing  until the  e "00:00" icon and "00:00" start flashing on the display.





































































Use  $+$  or  $-$  to set the time you require and press  to confirm.





An audible signal will sound once the timer has finished counting down the selected time.

Notes: To cancel the timer, keep pressing  until the  icon starts flashing, then use  $-$  to reset the time to "00:00".

# COOKING TABLE

RECIPE	FUNCTION	PREHEATING	TEMPERATURE (°C)	DURATION (MIN)	LEVEL AND ACCESSORIES
<b>Leavened cakes</b>		Yes	160 - 180	30 - 90	2/3 
		Yes	160 - 180	30 - 90	4 1  
<b>Filled cake</b> (cheese cake, strudel, fruit pie)		Yes	160 - 200	35 - 90	2 
		Yes	160 - 200	40 - 90	4 2  
<b>Biscuits/tartlets</b>		Yes	160 - 180	20 - 45	3 
		Yes	150 - 170	20 - 45	4 2  
		Yes	150 - 170	20 - 45	5 3 1   
<b>Choux buns</b>		Yes	180 - 210	30 - 40	3 
		Yes	180 - 200	35 - 45	4 2  
		Yes	180 - 200	35 - 45	5 3 1   
<b>Meringues</b>		Yes	90	150 - 200	3 
		Yes	90	140 - 200	4 2  
		Yes	90	140 - 200	5 3 1   
<b>Pizza / bread</b>		Yes	190 - 250	15 - 50	1 / 2 
		Yes	190 - 250	20 - 50	4 2  
<b>Frozen pizza</b>		Yes	250	10 - 20	3 
		Yes	230 - 250	10 - 25	4 2  
<b>Salty cakes</b> (vegetable pie, quiche)		Yes	180 - 200	40 - 55	3 
		Yes	180 - 200	45 - 60	4 2  
		Yes	180 - 200	45 - 60	5 3 1   
<b>Vols-au-vents / puff pastry crackers</b>		-	190 - 200	20 - 30	3 
		-	180 - 190	20 - 40	4 2  
		-	180 - 190	20 - 40	5 3 1   
<b>Lasagne / baked pasta / cannelloni / flans</b>		Yes	190 - 200	45 - 65	2 

FUNCTIONS							
	Conventional	Grill	Gratin	Pizza	Multilevel	XL cooking	Eco Forced Air

ACCESSORIES					
	Wire shelf	Baking dish on the wire shelf	Baking tray / baking dish on the wire shelf	Baking tray	Baking tray with 200 ml of water

RECIPE	FUNCTION	PREHEATING	TEMPERATURE (°C)	DURATION (MIN)	LEVEL AND ACCESSORIES
Lamb / veal / beef / pork 1 kg		Yes	190 - 200	80 - 110	3
Roast pork with crackling 2 kg		Yes	180 - 190	110 - 150	2
Chicken/rabbit/duck 1 kg		Yes	200 - 230	50 - 100	2
Turkey / goose 3 kg		-	190 - 200	100 - 160	2
Baked fish / en papillote (fillets, whole)		Yes	170 - 190	30 - 50	2
Stuffed vegetables (tomatoes, courgettes, aubergines)		Yes	180 - 200	50 - 70	2
Toasted bread		-	250	2 - 6	5
Fish fillets/slices		-	230 - 250	20 - 30*	4 3
Sausages / kebabs / spare ribs / hamburgers		-	250	15 - 30*	5 4
Roast chicken 1-1,3 kg		Yes	200 - 220	55 - 70**	2 1
Roast beef rare 1 kg		Yes	200 - 210	35 - 50**	3
Leg of lamb / knuckle		Yes	200 - 210	60 - 90**	3
Roast potatoes		Yes	200 - 210	35 - 55**	3
Vegetable gratin		-	200 - 210	25 - 55	3
Meat and potatoes		Yes	190 - 200	45 - 100***	4 1
Fish and vegetables		Yes	180	30 - 50***	4 1
Lasagne and meat		Yes	200	50 - 100***	4 1
Complete meal: fruit tart (level 5) / lasagne (level 3) / meat (level 1)		Yes	180 - 190	40 - 120***	5 3 1
Roast meat/stuffed roasting joints		-	170 - 180	100 - 150	2

The time indicated does not include the preheating phase: we recommend placing the food in the oven and setting the cooking time only after the required temperature has been reached.

\* Turn food halfway through cooking.

\*\* Turn food two thirds of the way through cooking (if necessary).

\*\*\* Estimated length of time: dishes can be removed from the oven at different times depending on personal preference.

Download the Use and Care Guide from [docs.indesit.eu](https://docs.indesit.eu) for the table of tested recipes, compiled for the certification authorities in accordance with the standard IEC 60350-1.

FUNCTIONS							
	Conventional	Grill	Gratin	Pizza	Multilevel	XL cooking	Eco Forced Air
ACCESSORIES							
	Wire shelf	Baking dish on the wire shelf	Baking tray / baking dish on the wire shelf	Baking tray	Baking tray with 200 ml of water		

# MAINTENANCE AND CLEANING



Download the Use and Care Guide from [docs.indesit.eu](https://docs.indesit.eu) for more information

**Do not use steam cleaning equipment.**

**Use protective gloves during all operations.**

**Carry out the required operations with the oven cold.**

**Disconnect the appliance from the power supply.**

**Do not use wire wool, abrasive scourers or abrasive/corrosive cleaning agents, as these could damage the surfaces of the appliance.**

## EXTERIOR SURFACES

Clean the surfaces with a damp microfibre cloth. If they are very dirty, add a few drops of pH-neutral detergent. Finish off with a dry cloth. Do not use corrosive or abrasive detergents. If any of these products inadvertently comes into contact with the surfaces of the appliance, clean immediately with a damp microfibre cloth.

## INTERIOR SURFACES

• After every use, leave the oven to cool and then clean it, preferably while it is still warm, to remove any deposits or stains caused by food residues. To dry any condensation that has formed as a result of cooking foods with a high water content, leave the oven to cool completely and then wipe it with a cloth or sponge.

- Activate the "Hydrocleaning" function for optimum cleaning of internal surfaces.
- The door can be easily removed and refitted to facilitate cleaning of the glass
- Clean the glass in the door with a suitable liquid detergent.
- The top heating element of the grill can be lowered to clean the upper panel of the oven.

## ACCESSORIES

Soak the accessories in a washing-up liquid solution after use, handling them with oven gloves if they are still hot. Food residues can be removed using a washing-up brush or a sponge.

## REMOVING AND REFITTING THE DOOR

**1.** To remove the door, open it fully and lower the catches until they are in the unlock position.

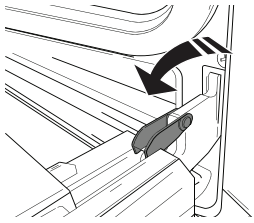

**2.** Close the door as much as you can. Take a firm hold of the door with both hands – do not hold it by the handle. Simply remove the door by continuing to close it while pulling it upwards (a) at the same time until it is released from its seating (b).

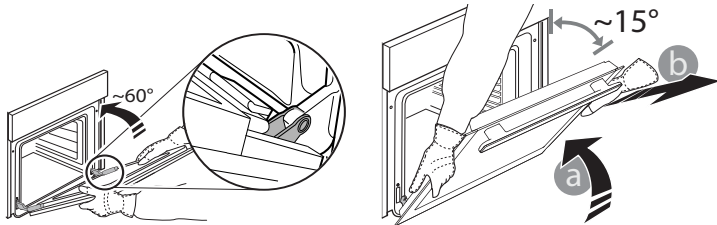

Put the door to one side, resting it on a soft surface.

**3.** Refit the door by moving it towards the oven, aligning the hooks of the hinges with their seating and securing the upper part onto its seating.

**4.** Lower the door and then open it fully. Lower the catches into their original position: make sure that you lower them down completely.

**5.** Try closing the door and check to make sure that it lines up with the control panel. If it does not, repeat the steps above.

## CLICK TO CLEAN - CLEANING THE GLASS

**1.** After removing the door and resting it on a soft surface with the handle downwards, simultaneously press the two retaining clips and remove the upper edge of the door by pulling it towards you.

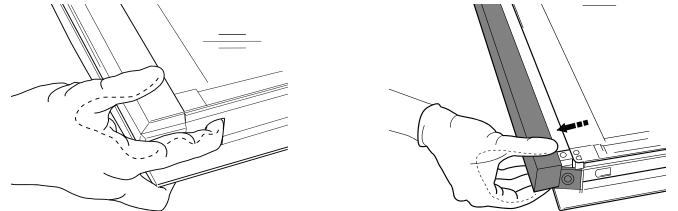

**2.** Lift and firmly hold the inner glass with both hands, remove it and place it on a soft surface before cleaning it.

**3.** To correctly reposition the inner glass, make sure that the "R" is visible in the left-hand corner and the clear surface (not printed) is facing up. First insert the long side of the glass indicated by "R" into the support seats, then lower it into position.

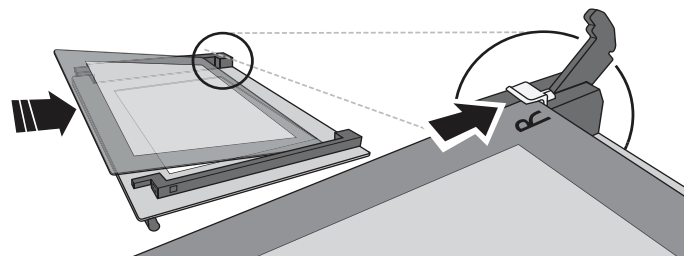

**4.** Refit the upper edge: a click will indicate correct positioning. Make sure the seal is secure before refitting the door.

Problem	Possible cause	Solution
The oven does not work.	Power cut. Disconnection from the mains.	Check for the presence of mains electrical power and whether the oven is connected to the electricity supply. Turn off the oven and restart it to see if the fault persists.
The display shows the letter "F" followed by a number.	Software problem.	Contact you nearest After-sales Service Centre and state the letter or number that follows the letter "F".

## USEFUL TIPS



Download the Use and Care Guide from [docs.indesit.eu](http://docs.indesit.eu) for more information

### HOW TO READ THE COOKING TABLE

The table lists the best function, accessories and level to use to cook various different types of food. Cooking times start from the moment food is placed in the oven, excluding preheating (where required). Cooking temperatures and times are approximate and depend on the amount of food and the type of accessory used. Use the lowest recommended settings to begin with and, if the food is not cooked enough, then switch to higher settings. Use the accessories supplied and preferably dark-coloured metal cake tins and baking trays. You can also use Pyrex or stoneware pans and accessories, but bear in mind that cooking times will be slightly longer.

### COOKING DIFFERENT FOODS AT THE SAME TIME

The "Multilevel" function enables you to cook different foods (such as fish and vegetables) on different shelves at the same time. Remove the food which requires a shorter cooking time and leave the food which requires a longer cooking time in the oven.

### PRODUCT FICHE

The product fiche with energy data of this appliance can be downloaded from the website [docs.indesit.eu](http://docs.indesit.eu)

### HOW TO OBTAIN THE USE AND CARE GUIDE

> Download the Use and Care Guide from our website [docs.indesit.eu](http://docs.indesit.eu) (you can use this QR Code), specifying the product's commercial code.



> Alternatively, contact our Client After-sales Service.

### CONTACTING OUR AFTER-SALES SERVICE

You can find our contact details in the warranty manual. When contacting our Client After-sales Service, please state the codes provided on your product's identification plate.

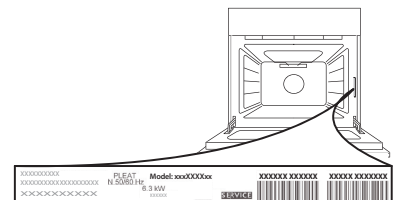



# GUIDA RAPIDA



## GRAZIE PER AVERE ACQUISTATO UN PRODOTTO INDESIT

Per ricevere un'assistenza più completa, registrare il prodotto su [www.indesit.com/register](http://www.indesit.com/register)



Scaricare le istruzioni per la sicurezza e le istruzioni per l'uso collegandosi al sito [docs.indesit.eu](http://docs.indesit.eu) e seguire la procedura indicata sul retro.

**!** Leggere attentamente le istruzioni per la sicurezza prima di utilizzare il prodotto.

## DESCRIZIONE PRODOTTO

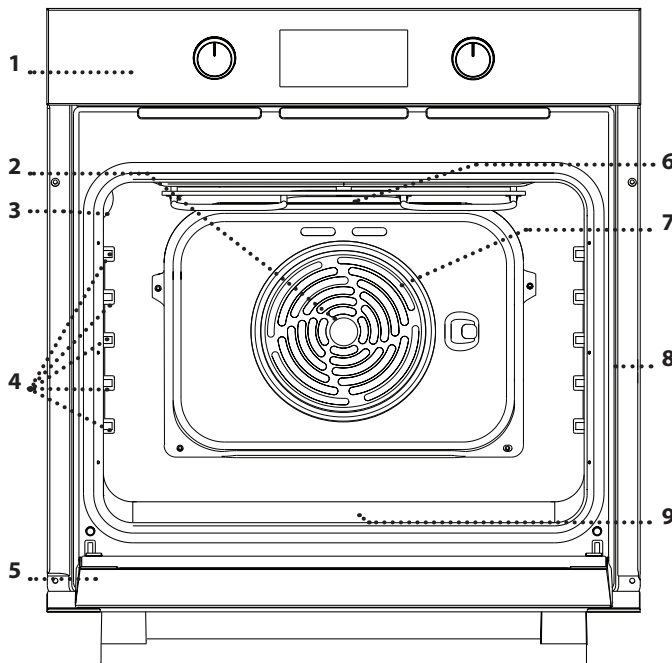

1. Pannello di controllo
2. Ventola
3. Lampada
4. Griglie laterali (il livello è indicato sulla parete della cavità)
5. Porta
6. Resistenza superiore / grill
7. Resistenza circolare (non visibile)
8. Targhetta matricola (da non rimuovere)
9. Resistenza inferiore (non visibile)

## PANNELLO DEI COMANDI

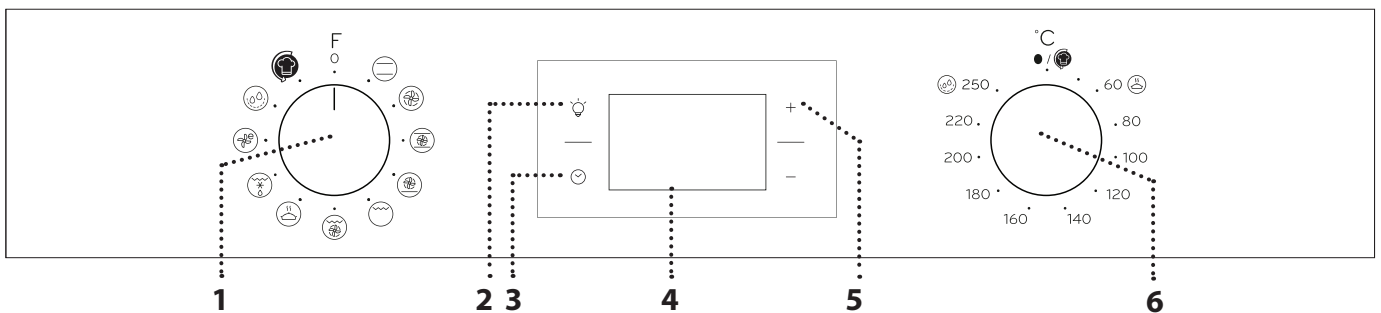

### 1. MANOPOLA DI SELEZIONE

Per accendere il forno selezionando una funzione. Per spegnere il forno, ruotare sulla posizione 0.

### 2. LUCE

A forno acceso, premere per accendere o spegnere la luce interna del forno.

### 3. IMPOSTARE L'ORA

Per accedere alle impostazioni del tempo di cottura, dell'avvio ritardato e del timer. Per visualizzare l'ora con il forno spento.

### 4. DISPLAY

### 5. TASTI DI REGOLAZIONE

Per modificare le impostazioni di durata.

### 6. MANOPOLA TERMOSTATO

Ruotare per selezionare la temperatura desiderata attivando le funzioni manuali. Per le funzioni automatiche usare

## GRIGLIA

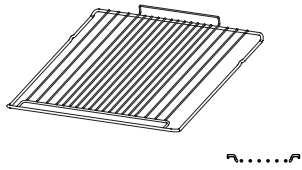

## PIASTRA DOLCI

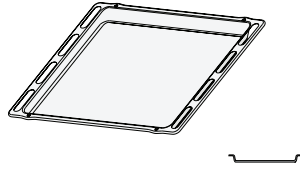

Il numero e il tipo di accessori possono variare a seconda del modello acquistato. È possibile acquistare separatamente altri accessori presso il Servizio Assistenza Clienti.

## USO DEGLI ACCESSORI

• Inserire la griglia tenendola leggermente inclinata verso l'alto, appoggiando dapprima il lato posteriore rialzato - orientato verso l'alto - sul livello desiderato. In seguito, farla scivolare orizzontalmente sulla griglia laterale fino a fine corsa.

Gli altri accessori, come la teglia, si inseriscono orizzontalmente facendoli scivolare sulle guide laterali.

• Per facilitare la pulizia del forno è possibile rimuovere le guide laterali, tirandole in modo da estrarle dalle sedi.

# FUNZIONI



### STATICO

Per cuocere qualsiasi tipo di pietanza su un solo ripiano.



### MULTILIVELLO

Per cuocere contemporaneamente su più ripiani (massimo tre) alimenti, anche diversi, che richiedono medesima temperatura di cottura. La funzione permette di cuocere senza trasmissione di odori da un alimento all'altro.



### XL COOKING

Per cuocere carni di grosse dimensioni (superiori ai 2,5 kg). Si raccomanda di girare la carne durante la cottura per farla rosolare su tutti i lati. Si consiglia inoltre di irrorare la carne di tanto in tanto per evitare che asciughi eccessivamente.



### PIZZA

Per cuocere diversi tipi e formati di pizza e focaccia. Si consiglia di invertire la posizione delle teglie a metà cottura.



### GRILL

Per grigliare costate, spiedini e salsicce, gratinare verdure o dorare il pane. Quando si cuoce la carne alla griglia, si consiglia di utilizzare una leccarda per raccogliere il liquido di cottura: posizionarla un livello sotto la griglia e aggiungere 200 ml di acqua potabile.



### GRATIN

Per arrostiti grossi pezzi di carne (cosciotti, roast beef, polli). Si consiglia di utilizzare una leccarda per raccogliere il liquido di cottura: posizionarla un livello sotto la griglia e aggiungere 200 ml di acqua potabile.



### MANTENERE IN CALDO

Per ottenere una lievitazione ottimale di impasti dolci o salati. Per preservare la qualità della lievitazione, non attivare la funzione se il forno è ancora caldo dopo un ciclo di cottura.



### FREASY COOK

Vengono attivate tutte le resistenze e la ventola, per garantire una distribuzione regolare e uniforme del calore in tutto il forno. Il preriscaldamento non è necessario. Questa modalità è particolarmente consigliata per cuocere rapidamente pietanze preconfezionate (surgelate o precotte). Per ottenere risultati ottimali si consiglia di usare una sola griglia.



### ECO TERMOVENTILATO

Per cuocere arrostiti e arrostiti ripieni su uno stesso ripiano. La circolazione intermittente dell'aria impedisce un'eccessiva asciugatura degli alimenti. In questa funzione ECO la luce rimane spenta durante la cottura e può essere riaccesa premendo .



### HYDROCLEANING

L'azione del vapore rilasciato durante questo speciale ciclo di pulizia a bassa temperatura permette di rimuovere facilmente sporco e residui di cibo. Versare 200 ml di acqua potabile sul fondo del forno e attivare la funzione per 35' a 90°C. Attivare la funzione a forno freddo e lasciarlo raffreddare per 15' al termine del ciclo.





### TURN & GO

Questa funzione seleziona automaticamente la temperatura e il tempo ottimali per un'ampia varietà di ricette, tra cui carne, pesce, pasta, dolci e verdure. Attivare la funzione a forno freddo.

# PRIMO UTILIZZO

## 1. IMPOSTARE L'ORA

Alla prima accensione, è necessario impostare l'ora: premere  finché sul display lampeggiano l'icona  e le due cifre relative all'ora.



Utilizzare + o - per impostare l'ora e premere  per confermare. Sul display lampeggiano le due cifre relative ai minuti: utilizzare + o - per impostare i minuti e premere  per confermare.

Note: quando l'icona  lampeggia, ad esempio dopo una prolungata interruzione di corrente, è necessario impostare l'ora.

## 2. RISCALDARE IL FORNO

Un nuovo forno può rilasciare degli odori dovuti alla lavorazione di fabbrica: questo è normale. Prima di cucinare gli alimenti è dunque raccomandato di riscaldare a vuoto il forno per rimuovere ogni odore.

Rimuovere protezioni di cartone o pellicole trasparenti e togliere gli accessori dal forno. Scaldare il forno a 250 °C per un'ora, utilizzando preferibilmente la funzione "XL Cooking". Durante questa procedura il forno deve essere vuoto. Seguire le istruzioni a seguire per impostare correttamente la funzione.

Note: è opportuno ventilare la stanza durante e dopo il primo utilizzo.

# USO QUOTIDIANO

## 1. SELEZIONARE UNA FUNZIONE

Per selezionare una funzione, ruotare la *manopola di selezione* in corrispondenza del simbolo della funzione desiderata: il display si accende e il forno emette un segnale acustico.



## 2. AVVIARE UNA FUNZIONE

### MANUALE

Per avviare la funzione selezionata, ruotare la *manopola termostato* per impostare la temperatura desiderata.



Note: durante la cottura sarà possibile modificare la funzione ruotando la *manopola di selezione* o regolare la temperatura ruotando la *manopola termostato*.

La funzione non si avvia se la *manopola del termostato* è impostata su 0°C. Sarà possibile impostare durata, ora di fine cottura (solo se è impostata una durata) e timer.

### TURN & GO

Per avviare la funzione "Turn & Go", ruotare la *manopola di selezione* sull'icona corrispondente tenendo la *manopola del termostato* sull'icona . Per terminare la cottura, ruotare la *manopola di selezione* su "0".

Note: Per ottenere risultati ottimali con la funzione "Turn & Go", seguire le indicazioni sui pesi riportate nella tabella seguente per i diversi tipi di alimenti.

Alimento	Ricetta	Peso (kg)
Carni	Arrostito di vitello, roastbeef al sangue	0,6 - 0,7
	Pollo / Cosciotto d'agnello in pezzi	1,0 - 1,2
Pesce	Filetto di salmone / Pesce al forno (intero)	0,9 - 1,0
	Pesce al cartoccio	0,8 - 1,0
Verdure	Verdure ripiene	1,8 - 2,5
	Torta alle verdure	1,5 - 2,5
Torte salate	Quiche Lorraine / Sformati	1,0 - 1,5
Pasta	Lasagne / Timballi di pasta o riso	1,5 - 2,0
Torte	Torte lievitate / Plum cake	0,9 - 1,2
	Mele al forno	1,0 - 1,5
Pane	Pagnotta	0,5 - 0,6
	Baguette	0,5 - 0,8

### MANTENERE IN CALDO

Per avviare la funzione "Mantenere in caldo", ruotare la *manopola del termostato* sul simbolo corrispondente; se il forno è impostato su una temperatura differente (o se la temperatura interna è superiore a 65°C) la funzione non si avvia.

Note: sarà possibile impostare durata, ora di fine cottura (solo se è impostata una durata) e timer.

### 3. PRERISCALDAMENTO

Una volta avviata la funzione, un segnale acustico e l'icona  lampeggiante sul display segnalano che si è attivata la fase di preriscaldamento.

Al termine di questa fase, un segnale acustico e l'icona  fissa sul display indicheranno che il forno ha raggiunto la temperatura impostata: a questo punto, inserire gli alimenti e procedere alla cottura.

Note: inserire gli alimenti nel forno prima della fine del preriscaldamento può compromettere i risultati di cottura.

#### . PROGRAMMARE LA COTTURA

Per programmare la cottura è necessario aver selezionato precedentemente una funzione.



##### DURATA

Premere  tante volte fino a che sul display lampeggiano l'icona  e "00:00".





Utilizzare + o - per impostare la durata desiderata, quindi premere  per confermare.

Attivare la funzione ruotando la *manopola termostato* in corrispondenza della temperatura desiderata o necessaria: un segnale acustico e il display avviseranno del termine della cottura.

Note: per annullare la durata impostata, premere  tante volte fino a che sul display lampeggia l'icona , quindi utilizzare - per riportare la durata a "00:00". La durata impostata include la fase di preriscaldamento.

#### PROGRAMMARE L'ORA DI FINE COTTURA / AVVIO RITARDATO

Una volta impostata una durata sarà possibile posticipare l'avvio della funzione, programmandone l'ora di fine: premere  fino a che sul display non lampeggiano l'icona  e l'ora corrente.



Utilizzare + o - per impostare l'ora di fine cottura desiderata e premere  per confermare.

Attivare la funzione ruotando la *manopola termostato* in corrispondenza della temperatura desiderata o necessaria: la funzione resterà in pausa fino ad avviarsi automaticamente dopo un periodo di tempo calcolato per terminare la cottura all'orario impostato.

Note: per annullare l'impostazione, spegnere il forno ruotando la *manopola di selezione* sulla posizione 0.

Note: Il ritardo di avvio della funzionalità non è disponibile per le funzioni Grill e Turbo Grill.

#### FINE COTTURA

Un segnale acustico e il display avvisano del termine della funzione.





Ruotare la *manopola di selezione* per selezionare una funzione differente o sulla posizione "0" per spegnere il forno.

Nota: se attivo il timer, il display mostrerà la scritta "END" in alternanza al tempo rimanente.



#### . IMPOSTARE IL TIMER

Questa opzione non interrompe né programma la cottura ma permette di utilizzare il display come contaminuti, sia durante una funzione attiva che quando il forno è spento.



































































Premere ripetutamente  finché sul display lampeggiano l'icona  e "00:00".



Utilizzare + o - per impostare la durata desiderata e premere  per confermare. Un segnale acustico avviserà del termine del conto alla rovescia.

Note: per disattivare il timer, premere  tante volte fino a che l'icona  lampeggia, quindi utilizzare - per riportare la durata a "00:00".

# TABELLA DI COTTURA

RICETTA	FUNZIONE	PRERISCALDA- MENTO	TEMPERATURA (°C)	DURATA (MIN)	LIVELLO E ACCESSORI
<b>Torte a lievitazione</b>		Sì	160 - 180	30 - 90	2/3 
		Sì	160 - 180	30 - 90	4 1  
<b>Torte ripiene</b> (cheese cake, strudel, torta di frutta)		Sì	160 - 200	35 - 90	2 
		Sì	160 - 200	40 - 90	4 2  
<b>Biscotti/Tortine</b>		Sì	160 - 180	20 - 45	3 
		Sì	150 - 170	20 - 45	4 2  
		Sì	150 - 170	20 - 45	5 3 1   
<b>Bignè</b>		Sì	180 - 210	30 - 40	3 
		Sì	180 - 200	35 - 45	4 2  
		Sì	180 - 200	35 - 45	5 3 1   
<b>Meringhe</b>		Sì	90	150 - 200	3 
		Sì	90	140 - 200	4 2  
		Sì	90	140 - 200	5 3 1   
<b>Pizza / Focaccia</b>		Sì	190 - 250	15 - 50	1 / 2 
		Sì	190 - 250	20 - 50	4 2  
<b>Pizze surgelate</b>		Sì	250	10 - 20	3 
		Sì	230 - 250	10 - 25	4 2  
<b>Torte salate</b> (torta di verdura, quiche)		Sì	180 - 200	40 - 55	3 
		Sì	180 - 200	45 - 60	4 2  
		Sì	180 - 200	45 - 60	5 3 1   
<b>Vol-au-vent / Salatini di pasta sfoglia</b>		-	190 - 200	20 - 30	3 
		-	180 - 190	20 - 40	4 2  
		-	180 - 190	20 - 40	5 3 1   
<b>Lasagne / Pasta al forno / Cannelloni / Sfornati</b>		Sì	190 - 200	45 - 65	2 

FUNZIONI							
	Statico	Grill	Gratin	Pizza	Multilivello	XL cooking	Eco Termoventilato
ACCESSORI							
	Griglia	Recipiente su griglia	Tortiera o teglia su griglia	Piastra dolci	Piastra dolci con 200ml di acqua		

RICETTA	FUNZIONE	PRERISCALDAMENTO	TEMPERATURA (°C)	DURATA (MIN)	LIVELLO E ACCESSORI
<b>Agnello / Vitello / Manzo / Maiale</b> 1 kg		Sì	190 - 200	80 - 110	3
<b>Arrosto di maiale con cotenna</b> 2kg		Sì	180 - 190	110 - 150	2
<b>Pollo / Coniglio / Anatra</b> 1 kg		Sì	200 - 230	50 - 100	2
<b>Tacchino / Oca</b> 3 kg		-	190 - 200	100 - 160	2
<b>Pesce al forno / al cartoccio</b> (filetti, intero)		Sì	170 - 190	30 - 50	2
<b>Verdure ripiene</b> (pomodori, zucchine, melanzane)		Sì	180 - 200	50 - 70	2
<b>Pane tostato</b>		-	250	2 - 6	5
<b>Filetti / tranci di pesce</b>		-	230 - 250	20 - 30*	4 3
<b>Salsicce / Spiedini / Costine / Hamburger</b>		-	250	15 - 30*	5 4
<b>Pollo arrosto</b> 1-1,3 kg		Sì	200 - 220	55 - 70**	2 1
<b>Roast beef al sangue</b> 1 kg		Sì	200 - 210	35 - 50**	3
<b>Cosciotto di agnello / Stinchi</b>		Sì	200 - 210	60 - 90**	3
<b>Patate arrosto</b>		Sì	200 - 210	35 - 55**	3
<b>Verdure gratinate</b>		-	200 - 210	25 - 55	3
<b>Carne &amp; Patate</b>		Sì	190 - 200	45 - 100***	4 1
<b>Pesce &amp; Verdure</b>		Sì	180	30 - 50***	4 1
<b>Lasagna &amp; Carne</b>		Sì	200	50 - 100***	4 1
<b>Pasto completo: Crostata</b> (Liv. 5) / <b>Lasagna</b> (Liv. 3) / <b>Carne</b> (Liv. 1)		Sì	180 - 190	40 - 120***	5 3 1
<b>Arrosti / Arrosti ripieni</b>		-	170 - 180	100 - 150	2

La durata indicata non comprende la fase di preriscaldamento: si consiglia di inserire gli alimenti nel forno e di impostare la durata della cottura solo al raggiungimento della temperatura desiderata.

\* Ruotare il cibo a metà cottura.

\*\* Ruotare il cibo a due terzi di cottura se necessario.

\*\*\* La durata è approssimata: le pietanze possono essere tolte dal forno in tempi differenti secondo preferenza.

Scaricare le Istruzioni per l'uso dal sito [docs.indesit.eu](http://docs.indesit.eu) per consultare la tabella delle ricette testate, compilata per gli istituti di valutazione secondo la norma CEI 60350-1.

FUNZIONI							
	Statico	Grill	Gratin	Pizza	Multilivello	XL cooking	Eco Termoventilato
ACCESSORI							
	Griglia	Recipiente su griglia	Tortiera o teglia su griglia	Piastra dolci	Piastra dolci con 200ml di acqua		

# MANUTENZIONE E PULIZIA



Per maggiori informazioni, scaricare le istruzioni per l'uso da [docs.indesit.eu](http://docs.indesit.eu)

**Non usare pulitrici a getto di vapore.**

**Utilizzare guanti protettivi durante tutte le operazioni.**

**Eseguire le operazioni indicate a forno freddo.**

**Scollegare l'apparecchio dalla rete elettrica.**

**Non usare pagliette metalliche, panni abrasivi e detersivi abrasivi o corrosivi che possano danneggiare le superfici.**

## SUPERFICI ESTERNE

Pulire le superfici con un panno in microfibra umido. Se molto sporche, aggiungere qualche goccia di detersivo neutro. Asciugare con un panno asciutto. Non usare detersivi corrosivi o abrasivi. Se inavvertitamente uno di questi prodotti dovesse venire a contatto con le superfici, pulire subito con un panno in microfibra umido.

## SUPERFICI INTERNE

• Dopo ogni uso, lasciare raffreddare il forno e pulirlo preferibilmente quando è ancora tiepido per rimuovere incrostazioni e macchie dovute a residui di cibo; per asciugare la condensa dovuta alla cottura di alimenti con un elevato contenuto di acqua, usare a forno freddo un panno o una spugna.

- Attivare la funzione "Hydrocleaning" per una pulizia ottimale delle superfici interne.
- Per facilitare la pulizia dei vetri è possibile rimuovere e smontare facilmente la porta .
- Pulire i vetri della porta con detersivi liquidi specifici.
- La resistenza superiore del grill può essere abbassata per pulire la parete superiore del forno.

## ACCESSORI

Mettere a bagno gli accessori con detersivo per piatti dopo l'uso, maneggiandoli con guanti da forno, se ancora caldi. I residui di cibo possono essere rimossi con una spazzola per piatti o con una spugna.

## TOGLIERE E RIMONTARE LA PORTA

**1.** Per rimuovere la porta, aprirla completamente e abbassare i fermi fino alla posizione di sblocco.

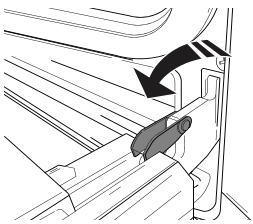

**2.** Chiudere la porta fino a quando è possibile. Prendere saldamente la porta con entrambe le mani, evitando di tenerla per la maniglia. Per estrarla facilmente, continuare a chiuderla e contemporaneamente tirarla verso l'alto (a) finché non esce dalle sedi (b).

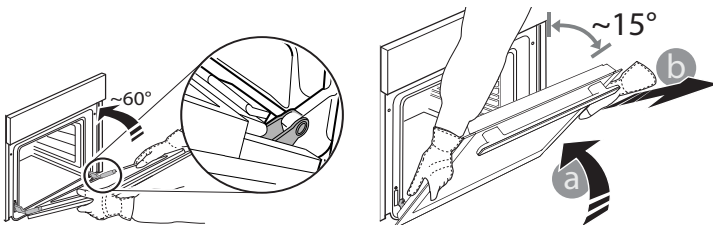

Togliere la porta e appoggiarla su un piano morbido.

**3.** Per rimontare la porta, avvicinarla al forno allineando i ganci delle cerniere alle proprie sedi e ancorare la parte superiore agli alloggiamenti.

**4.** Abbassare la porta e poi aprirla completamente. Abbassare i fermi nella posizione originale: fare attenzione che siano completamente abbassati.

**5.** Provare a chiudere la porta, verificando che sia allineata al pannello di controllo. Se non lo fosse, ripetere tutte le operazioni.

## CLICK&CLEAN - PULIRE IL VETRO

**1.** Dopo aver smontato la porta e averla appoggiata su un ripiano morbido con la maniglia verso il basso, premere contemporaneamente le due clip di fissaggio ed estrarre il profilo superiore della porta tirandolo verso di sé.

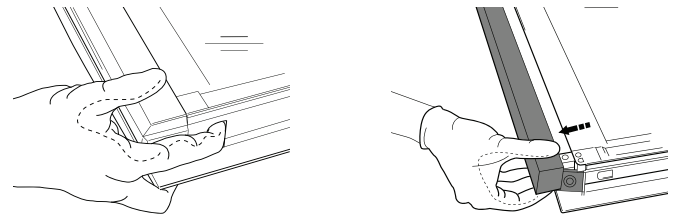

**2.** Sollevare e prendere saldamente il vetro interno con due mani, rimuoverlo e appoggiarlo su un piano morbido prima di eseguire la pulizia.

**3.** Per riposizionare correttamente il vetro interno, fare attenzione che la "R" sia leggibile nell'angolo destro e che la superficie lucida (non stampata) sia rivolta verso l'alto. Inserire dapprima il lato lungo del vetro indicato dalla "R" nelle sedi di sostegno, quindi abbassarlo in posizione.

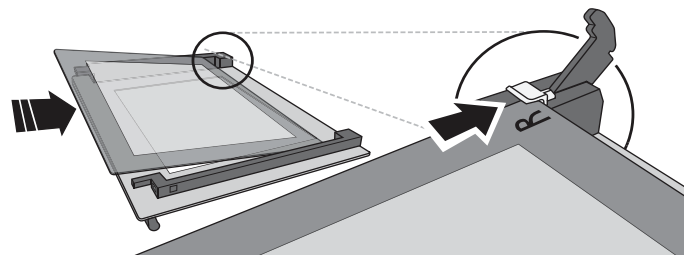

**4.** Rimontare il profilo superiore: un clic indica il corretto posizionamento. Verificare che la tenuta sia salda prima di rimontare la porta.

# RISOLUZIONE DEI PROBLEMI



Per maggiori informazioni, scaricare le istruzioni per l'uso da [docs.indesit.eu](http://docs.indesit.eu)

Problema	Possibile causa	Soluzione
Il forno non funziona.	Interruzione di corrente elettrica. Disconnessione dalla rete principale.	Verificare che ci sia tensione in rete e che il forno sia collegato all'alimentazione elettrica. Spegnere e riaccendere il forno e verificare se l'inconveniente persiste.
Il display mostra la lettera "F" seguita da un numero.	Problema software.	Contattare il Servizio Assistenza di zona e comunicare la lettera o il numero che segue la lettera "F".

## CONSIGLI UTILI



Per maggiori informazioni, scaricare le istruzioni per l'uso da [docs.indesit.eu](http://docs.indesit.eu)

### COME LEGGERE LA TABELLA DI COTTURA

La tabella indica la funzione, gli accessori e il livello migliore da utilizzare per cuocere svariati tipi di cibo. I tempi di cottura si riferiscono all'introduzione del cibo nel forno, escluso il preriscaldamento (dove richiesto).

Le temperature e i tempi di cottura sono indicativi e dipendono dalla quantità di cibo e dal tipo di accessori. Utilizzare inizialmente i valori più bassi consigliati e, se il risultato della cottura non è quello desiderato, passare a quelli più alti. Si consiglia di utilizzare gli accessori in dotazione e tortiere o teglie possibilmente in metallo scuro. È possibile utilizzare anche pentole e accessori in pyrex o in ceramica, i tempi di cottura si allungheranno leggermente.

### CUCINARE DIFFERENTI ALIMENTI CONTEMPORANEAMENTE

Utilizzando la funzione "Multilivello" è possibile cuocere contemporaneamente alimenti diversi (ad esempio: pesce e verdure) su ripiani diversi. Estrarre i cibi che richiedono tempi di cottura inferiori e lasciare continuare la cottura per quelli con tempi più lunghi.

### SCHEDA TECNICA

La scheda tecnica del prodotto con i dati sul consumo energetico può essere scaricata dal sito web [docs.indesit.eu](http://docs.indesit.eu)

### COME OTTENERE LE ISTRUZIONI PER L'USO

> Scaricare le Istruzioni per l'uso dal sito web [docs.indesit.eu](http://docs.indesit.eu) (è possibile utilizzare questo codice QR) specificando il codice prodotto.



> In alternativa, contattare il Servizio di Assistenza Clienti.

### CONTATTARE IL SERVIZIO ASSISTENZA CLIENTI

I contatti possono essere trovati sul manuale di garanzia. Quando si contatta il Servizio Assistenza fornire i codici presenti sulla targhetta matricola del prodotto.

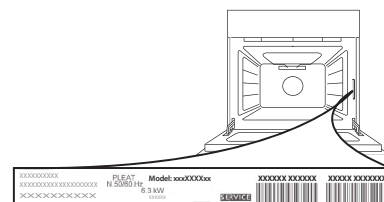



# GUIA DE CONSULTA DIÁRIA



## OBRIGADO POR ADQUIRIR UM PRODUTO INDESIT

Para receber mais informações e assistência, registe o seu produto em [www.indesit.com/register](http://www.indesit.com/register)



Pode transferir as Instruções de Segurança e o Guia de Utilização e Manutenção visitando o nosso website [docs.indesit.eu](http://docs.indesit.eu) e seguindo as instruções no verso do presente guia.



**Antes de utilizar o produto, leia atentamente as instruções de segurança.**

## DESCRIÇÃO DO PRODUTO

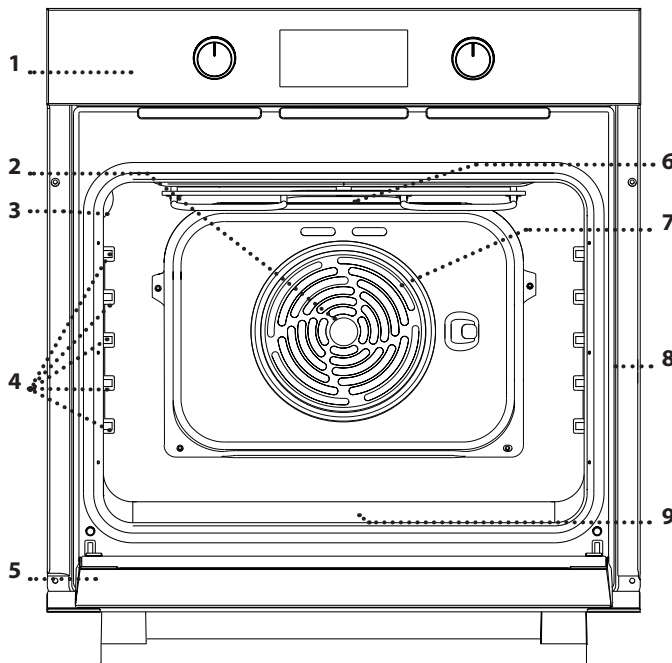

1. Painel de controlo
2. Ventoinha
3. Lâmpada
4. Guias de nível  
(o nível está indicado na parede do compartimento de cozedura)
5. Porta
6. Resistência superior / grill
7. Resistência circular (invisível)
8. Placa de identificação (não remover)
9. Resistência inferior (invisível)

## PAINEL DE COMANDOS

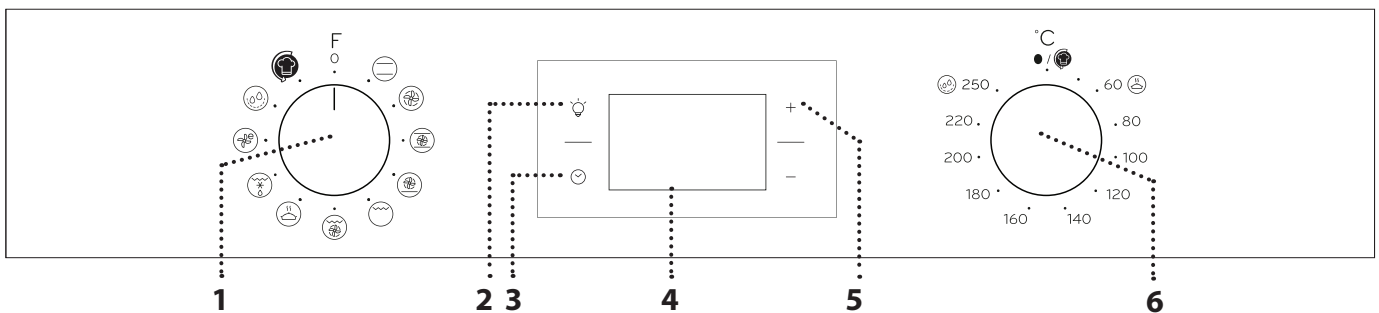

### 1. BOTÃO SELETOR

Para ligar o forno selecionando uma função.  
Para desligar o forno, rode o botão para a posição 0.

### 2. LUZ

Com o forno ligado, prima para ligar ou desligar a lâmpada do compartimento do forno.

### 3. AJUSTE DA HORA

Para aceder às definições do tempo de cozedura, de início diferido e do temporizador.  
Para apresentar o tempo em que o forno está desligado.

### 4. VISOR

### 5. BOTÕES DE AJUSTE

Para aceder às definições do tempo de cozedura.

### 6. BOTÃO DO TERMÓSTATO

Rode o botão para selecionar a temperatura pretendida ao ativar as funções manuais. Para as funções automáticas utilize

## GRELHA METÁLICA

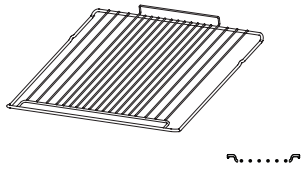

## TABULEIRO PARA ASSAR

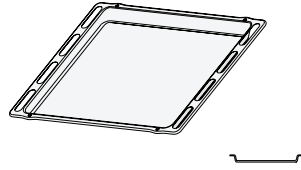

O número e o tipo de acessórios pode variar de acordo com o modelo adquirido. Pode adquirir separadamente outros acessórios no Serviço Pós-venda.

## UTILIZAÇÃO DOS ACESSÓRIOS

• Insira a grelha metálica no nível pretendido, segurando-a e inclinando-a ligeiramente para cima; em seguida, pouse a parte traseira levantada (apontando para cima) primeiro. Faça-a deslizar na horizontal pelas guias de nível tanto quanto possível.

Os outros acessórios, como o tabuleiro para assar, devem ser introduzidos horizontalmente, fazendo-os deslizar pelas guias.

• As guias de nível podem ser removidas para facilitar a limpeza: puxe-as para removê-las dos seus assentos.

## FUNÇÕES

### CONVENCIONAL

Para cozinhar qualquer tipo de alimento utilizando apenas um nível.

### MULTINÍVEL

Para cozinhar diferentes alimentos, que exijam a mesma temperatura de cozedura, em diferentes níveis (três, no máximo) e em simultâneo. Esta função permite cozinhar alimentos diferentes sem transmitir odores de uns alimentos para os outros.

### XL COOKING

Para cozinhar pedaços grandes de carne (acima de 2,5 kg). Recomendamos que vire a carne durante a cozedura, para assegurar que fica uniformemente dourada de ambos os lados. Também recomendamos que regue a carne esporadicamente, para evitar que fique excessivamente seca.

### PIZZA

Para cozinhar diferentes tipos e formatos de pão e pizza. Recomendamos que troque a posição dos tabuleiros de assar a meio do processo de cozedura.

### GRILL

Para grelhar bifes, espetadas, salsichas, gratinar legumes ou tostar pão. Ao grelhar carne, recomendamos a utilização de um tabuleiro para assar, para recolher os sucos da cozedura: posicione o tabuleiro em qualquer um dos níveis que se encontram abaixo da grelha e adicione 200 ml de água potável.

### GRATIN

Para assar peças de carne grandes (pernil, rosbife, frango). Recomendamos a utilização de um tabuleiro coletor, para recolher os sucos da cozedura: posicione o tabuleiro em qualquer um dos níveis que se encontram abaixo da grelha e adicione 200 ml de água potável.

### MANUTENÇÃO DO CALOR

Para uma levedação eficaz de massas doces ou salgadas. Para manter a qualidade da levedação, não ativar a função se o forno ainda estiver quente após um ciclo de cozedura.

### FREASY COOK

Todas as resistências, bem como a ventoinha são amovíveis, garantindo uma distribuição de calor consistente e uniforme em todo o forno. Não é necessário pré-aquecer o forno para este modo de cozedura. Este modo está especialmente recomendado para cozinhar alimentos pré-embalados rapidamente (congelados ou pré-cozinhados). Poderá obter os melhores resultados se utilizar apenas um nível de cozedura.

### AR FORÇADO ECO

Para assar peças de carne/peças de carne recheadas num único nível. Evita-se que os alimentos sequem excessivamente, através de uma circulação de ar suave e intermitente. Quando esta função está a ser utilizada, a luz mantém-se apagada ao longo da cozedura, mas pode acender-se temporariamente, premindo .

### HYDROCLEANING



A ação do vapor libertado durante este ciclo de limpeza a baixa temperatura especial permite a fácil remoção de resíduos de comida. Deite 200 ml de água potável no fundo do forno e ative a função durante 35 minutos a 90°C. Ative a função quando o forno estiver frio e deixe-o arrefecer durante 15 minutos após terminar o ciclo.

### TURN & GO



Esta função seleciona automaticamente a temperatura e a duração ideais para cozinhar uma grande variedade de pratos, incluindo carne, peixe, doces e legumes. Ative esta função apenas quando o forno estiver frio.

# PRIMEIRA UTILIZAÇÃO DO APARELHO

## 1. AJUSTE DA HORA

Ao ligar o aparelho pela primeira vez, terá de definir a hora: prima  até que o ícone  e os dois dígitos da hora comecem a piscar no visor.



Utilize + ou - para acertar a hora e prima  para confirmar. Os dois dígitos dos minutos começam a piscar. Utilize + ou - para definir os minutos e prima  para confirmar.

Lembre-se: Quando o ícone  está a piscar, por exemplo, durante cortes de energia prolongados, é necessário acertar a hora.

## 2. AQUECER O FORNO

Um forno novo pode libertar odores residuais, resultantes do processo de fabrico: isto é perfeitamente normal.

Assim, antes de começar a cozinhar alimentos, recomendamos que aqueça o forno, vazio, para eliminar eventuais odores.

Remova do forno qualquer elemento de proteção em cartão ou película transparente e retire quaisquer acessórios do respetivo interior.

Aqueça o forno a 250 °C durante cerca de uma hora, utilizando preferencialmente a função "XL Cooking". O forno deve estar vazio durante o aquecimento.

Siga as instruções para programar corretamente a função.

Lembre-se: É aconselhável arejar a cozinha após a primeira utilização do aparelho.

# UTILIZAÇÃO DIÁRIA

## 1. SELECIONAR UMA FUNÇÃO

Para selecionar uma função, rode o *botão seletor* para o símbolo da função que pretende selecionar: o visor acende-se e ouve-se um sinal sonoro.



## 2. ATIVAR UMA FUNÇÃO

### MANUAL

Para iniciar a função selecionada, rode o *botão do termóstato* para definir a temperatura requerida.



Lembre-se: Durante a cozedura é possível e alterar a função rodando o *botão seletor* ou regular a temperatura rodando o *botão do termóstato*.

A função só é iniciada se o *botão do termóstato* estiver na posição 0 °C. Pode definir o tempo de cozedura, o tempo de fim da cozedura (apenas se selecionar um tempo de cozedura) e um temporizador.

### TURN & GO

Para iniciar a função "Turn & Go", selecione a mesma rodando o *botão seletor* no ícone relevante e mantendo o *botão do termóstato* no ícone . Para terminar a cozedura, rode o *botão seletor* para "0".

Lembre-se: Para obter os melhores resultados de cozedura usando a função "Turn & Go", siga os pesos sugeridos para cada tipo de alimento contidos na tabela seguinte.

Alimento	Receita	Peso (kg)
Carne	Vitela assada, carne de vaca mal passada	0,6 - 0,7
	Frango / Perna de borrego em pedaços	1,0 - 1,2
Peixe	Filete de salmão / peixe assado (inteiro)	0,9 - 1,0
	Peixe em papelote	0,8 - 1,0
Legumes	Legumes recheados	1,8 - 2,5
	Tarte de legumes	1,5 - 2,5
Bolos salgados	Quiche lorraine / Flan	1,0 - 1,5
Massa	Lasanha / Timbale de massa ou de arroz	1,5 - 2,0
Bolos	Bolo fermentado / Bolo de frutas secas	0,9 - 1,2
	Maçãs assadas	1,0 - 1,5
Pão	Pão de forma	0,5 - 0,6
	Baguetes	0,5 - 0,8

### MANUTENÇÃO DO CALOR

Para dar início à função "Manutenção do calor", rode o *botão do termóstato* até ao ícone relevante; se o forno estiver configurado para uma temperatura diferente (ou se a temperatura da cavidade do forno for superior a 65 °C) não será possível ativar esta função.

Lembre-se: Pode definir o tempo de cozedura, o tempo de fim da cozedura (apenas se selecionar um tempo de cozedura) e um temporizador.

### 3. PRÉ-AQUECIMENTO

Uma vez iniciada a função, é emitido um sinal sonoro e o ícone  a piscar no visor indica que a fase de pré-aquecimento foi ativada.



Terminada a fase de pré-aquecimento, é emitido um sinal sonoro e o ícone  fixo no visor indicam que o forno atingiu a temperatura definida: nessa altura, coloque os alimentos no interior do forno e dê início à cozedura.

Lembre-se: Colocar os alimentos no forno antes de o pré-aquecimento estar concluído pode ter um efeito adverso no resultado final da cozedura.

### . PROGRAMAR A COZEDURA



É necessário selecionar uma função antes de programar a cozedura.

#### DURAÇÃO



Mantenha o ícone  premido até que o ícone  e a indicação "00:00" comece a piscar no visor.



Utilize + ou - para definir o tempo de cozedura pretendido e, em seguida, prima  para confirmar. Ative a função rodando o *botão do termóstato* para a temperatura requerida: é emitido um sinal sonoro e o visor indica que a cozedura está concluída.

Notas: Para cancelar o tempo de cozedura definido, mantenha premido o botão  até que o ícone  comece a piscar no visor e, em seguida, prima - para repor o tempo de cozedura para "00:00". Este tempo de cozedura inclui uma fase de pré-aquecimento.

### PROGRAMAR O TEMPO DE FIM/INÍCIO DIFERIDO DA COZEDURA

Após definir um tempo de cozedura, o início da função pode ser diferido, programando o tempo de fim: prima  até que o ícone  e a hora atual comecem a piscar no visor.



Utilize + ou - para definir o tempo de fim da cozedura pretendido e, em seguida, prima  para confirmar.

Ative a função rodando o *botão do termóstato* para a temperatura requerida: a função irá permanecer em pausa até ser iniciada automaticamente após o período de tempo calculado para concluir a cozedura à hora programada.

Notas: para cancelar a definição, desligue o forno rodando o *botão seletor* para a posição 0.

Notas: A funcionalidade de atraso de arranque não está disponível para as funções Grill e Turbo Grill.

### FIM DA COZEDURA

É emitido um sinal sonoro e o visor indica que a função está concluída.





Rode o *botão seletor* para selecionar uma outra função ou para a posição "0" para desligar o forno.

Lembre-se: Caso o temporizador esteja ativado, o visor indica a mensagem "END" alternada com o tempo restante.

### . PROGRAMAR O TEMPORIZADOR



Esta opção não interrompe, nem programa a cozedura mas permite-lhe utilizar o visor como temporizador, quer enquanto uma função está ativada, quer quando o forno está desligado.

Mantenha o ícone  premido até que o ícone  e a indicação "00:00" comece a piscar no visor.





































































Utilize + ou - para definir o tempo pretendido e prima  para confirmar.





Quando o temporizador terminar a contagem decrescente do tempo programado, ouvir-se-á um sinal sonoro.

Notas: Para cancelar o temporizador, mantenha premido o botão  até que o ícone  comece a piscar e, em seguida, utilize - para repor o tempo para "00:00".

# TABELA DE COZEDURA

RECEITA	FUNÇÃO	PRÉ-AQUECIMENTO	TEMPERATURA (°C)	DURAÇÃO (MIN.)	NÍVEL E ACESSÓRIOS
<b>Bolos com levedura</b>		Sim	160 - 180	30 - 90	2/3 
		Sim	160 - 180	30 - 90	4 1  
<b>Bolo recheado</b> (cheesecake, strudel, tarte de frutas)		Sim	160 - 200	35 - 90	2 
		Sim	160 - 200	40 - 90	4 2  
<b>Biscoitos/queques</b>		Sim	160 - 180	20 - 45	3 
		Sim	150 - 170	20 - 45	4 2  
		Sim	150 - 170	20 - 45	5 3 1   
<b>Massa choux</b>		Sim	180 - 210	30 - 40	3 
		Sim	180 - 200	35 - 45	4 2  
		Sim	180 - 200	35 - 45	5 3 1   
<b>Merengues</b>		Sim	90	150 - 200	3 
		Sim	90	140 - 200	4 2  
		Sim	90	140 - 200	5 3 1   
<b>Pizza/Pão</b>		Sim	190 - 250	15 - 50	1 / 2 
		Sim	190 - 250	20 - 50	4 2  
<b>Pizza congelada</b>		Sim	250	10 - 20	3 
		Sim	230 - 250	10 - 25	4 2  
<b>Bolos salgados</b> (tarte de legumes, quiche)		Sim	180 - 200	40 - 55	3 
		Sim	180 - 200	45 - 60	4 2  
		Sim	180 - 200	45 - 60	5 3 1   
<b>Vol-au-vents/ salgadinhos de massa folhada</b>		-	190 - 200	20 - 30	3 
		-	180 - 190	20 - 40	4 2  
		-	180 - 190	20 - 40	5 3 1   
<b>Lasanha/massa no forno/ canelones/flans</b>		Sim	190 - 200	45 - 65	2 

FUNÇÕES							
	Convencional	Grill	Gratin	Pizza	Multilevel	XL cooking	Ar forçado Eco

ACESSÓRIOS					
	Grelha	Forma para assar na grelha	Forma/tabuleiro para assar na grelha metálica	Tabuleiro para pastelaria	Tabuleiro para assar com 200 ml de água

RECEITA	FUNÇÃO	PRÉ-AQUECIMENTO	TEMPERATURA (°C)	DURAÇÃO (MIN.)	NÍVEL E ACESSÓRIOS
<b>Borrego / vitela / vaca / porco</b> 1 kg		Sim	190 - 200	80 - 110	3
<b>Lombo assado estaladiço</b> 2 kg		Sim	180 - 190	110 - 150	2
<b>Frango/coelho/pato</b> 1 kg		Sim	200 - 230	50 - 100	2
<b>Peru/ganso</b> 3 kg		-	190 - 200	100 - 160	2
<b>Peixe no forno/em papelote</b> (filetes, inteiro)		Sim	170 - 190	30 - 50	2
<b>Legumes recheados</b> (tomates, curgetes, beringelas)		Sim	180 - 200	50 - 70	2
<b>Pão tostado</b>		-	250	2 - 6	5
<b>Filetes/postas de peixe</b>		-	230 - 250	20 - 30*	4 3
<b>Salsichas/espetadas/costeletas/hambúrgueres</b>		-	250	15 - 30*	5 4
<b>Frango assado</b> 1 - 1,3 kg		Sim	200 - 220	55 - 70**	2 1
<b>Rosbife mal passado</b> 1 kg		Sim	200 - 210	35 - 50**	3
<b>Perna de borrego/pernis</b>		Sim	200 - 210	60 - 90**	3
<b>Batatas assadas</b>		Sim	200 - 210	35 - 55**	3
<b>Gratinado legumes</b>		-	200 - 210	25 - 55	3
<b>Carne e batatas</b>		Sim	190 - 200	45 - 100***	4 1
<b>Peixe e legumes</b>		Sim	180	30 - 50***	4 1
<b>Lasanha e carne</b>		Sim	200	50 - 100***	4 1
<b>Refeição completa: tarte de frutas</b> (nível 5)/ <b>lasanha</b> (nível 3)/ <b>carne</b> (nível 1)		Sim	180 - 190	40 - 120***	5 3 1
<b>Carne assada/carne assada recheada</b>		-	170 - 180	100 - 150	2

O tempo indicado não inclui a fase de pré-aquecimento: recomendamos que coloque os alimentos no forno e defina o tempo de cozedura apenas após o mesmo ter alcançado a temperatura requerida.

\* Vire o alimento a meio da cozedura.

\*\* Vire o alimento quando atingir dois terços do tempo de cozedura (se necessário).

\*\*\*Período de tempo estimado: Os alimentos podem ser retirados do forno quando o desejar, dependendo da preferência de cada um.

Transfira o Guia de Utilização e Manutenção em [docs.indesit.eu](https://docs.indesit.eu) para consultar a tabela de receitas testadas, compiladas para as autoridades de certificação de acordo com a norma IEC 60350-1.

FUNÇÕES							
	Convencional	Grill	Gratin	Pizza	Multilevel	XL cooking	Ar forçado Eco
ACESSÓRIOS							
	Grelha	Forma para assar na grelha	Forma/tabuleiro para assar na grelha metálica	Tabuleiro para pastelaria	Tabuleiro para assar com 200 ml de água	Tabuleiro para assar com 200 ml de água	Tabuleiro para assar com 200 ml de água

**Não utilize aparelhos de limpeza a vapor.**

**Use luvas de proteção durante todas as operações.**

**Realize as operações requeridas com o forno a frio.**

**Desligue o aparelho da corrente elétrica.**

**Não utilize palha de aço, esfregões abrasivos ou produtos de limpeza abrasivos/corrosivos, uma vez que estes podem danificar as superfícies do aparelho.**

### SUPERFÍCIES EXTERIORES

Limpe as superfícies com um pano de microfibra húmido. Se estiverem muito sujas, acrescente alguns pingos de detergente com PH neutro. Termine a limpeza com um pano seco.

Não utilize detergentes corrosivos ou abrasivos. Se algum destes produtos entrar, inadvertidamente, em contacto com as superfícies do aparelho, limpe imediatamente com um pano de microfibra úmido.

### SUPERFÍCIES INTERIORES

• Após cada utilização, deixe que o forno arrefeça e limpe-o, de preferência enquanto estiver morno, para remover eventuais depósitos ou manchas causados por resíduos de alimentos. Para secar qualquer condensação que se tenha formado devido à cozedura de alimentos com elevado teor de água, deixe o forno arrefecer completamente e limpe-o com um pano ou uma esponja.

- Ative a função "Hydrocleaning" para obter os melhores resultados de limpeza das superfícies internas do forno.
- A porta pode ser removida facilmente e instalada novamente para facilitar a limpeza do vidro 
- Limpe o vidro da porta com um detergente líquido adequado.
- A resistência superior da grelha pode ser baixada para limpar o painel superior do forno.

### ACESSÓRIOS

Após a utilização, coloque os acessórios numa solução líquida de limpeza, pegando nos mesmos com luvas de forno, caso ainda estejam quentes. Os restos de alimentos podem ser retirados com uma esponja ou escova de limpeza.

### REMOVER E REPOR A PORTA

**1.** Para remover a porta, abra-a totalmente e baixe as linguetas até ficarem na posição de desbloqueio.

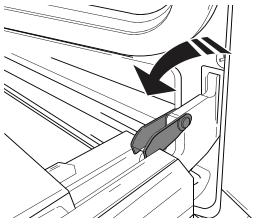

**2.** Feche a porta tanto quanto possível. Segure firmemente a porta com ambas as mãos – não a segure pela pega. Remova, simplesmente, a porta, continuando a fechá-la enquanto a puxa (a), simultaneamente, para cima, até se libertar do respetivo suporte (b).

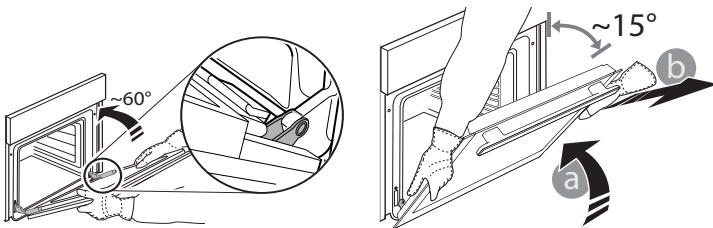

Coloque a porta de parte, apoiando-a sobre uma superfície suave.

**3.** Reponha a porta, deslocando-a na direção do forno e alinhando os ganchos das dobradiças com os respetivos suportes, fixando a parte superior aos suportes.

**4.** Baixe a porta e, em seguida, abra-a totalmente. Baixe as linguetas para a respetiva posição original: assegure-se de que as baixa totalmente.

**5.** Tente fechar a porta e assegure-se de que está alinhada com o painel de controlo. Se não estiver, repita os procedimentos acima.

### CLICK&CLEAN - LIMPAR O VIDRO

**1.** Após remover a porta e pousá-la sobre superfície suave, prima simultaneamente os dois grampos de retenção e remova a extremidade superior da porta, puxando-a na sua direção.

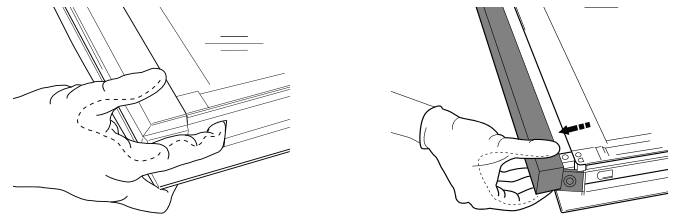

**2.** Levante e segure firmemente o vidro interior com ambas as mãos, removendo-o e colocando-o sobre uma superfície suave antes de proceder à sua limpeza.

**3.** Para voltar a instalar o vidro interior, certifique-se de que a letra "R" está visível no canto esquerdo e que a superfície límpida (não impressa) está voltada para cima. Insira primeiro a parte mais longa do vidro com a indicação "R" nos suportes e, em seguida, baixe-a até à posição correta.

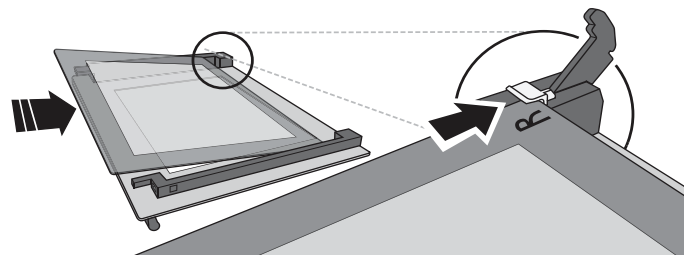

**4.** Instale novamente a extremidade superior: irá ouvir um clique, indicando que está bem posicionado. Certifique-se de que a vedação está segura antes de montar novamente a porta.



Problema	Causa possível	Solução
O forno não funciona.	Corte de energia. Desconexão da rede elétrica.	Verifique se existe energia elétrica proveniente da rede e se o forno está ligado à tomada elétrica. Desligue e volte a ligar o forno, para verificar se o problema ficou resolvido.
O visor apresenta a letra "F", seguida de um número.	Problema de software.	Contacte o Serviço Pós-Venda mais próximo e indique a letra ou o número que acompanha a letra "F".

## CONSELHOS ÚTEIS



Transfira o Guia de Utilização e Manutenção a partir do website **docs.indesit.eu** para obter mais informações

### COMO EFETUAR A LEITURA DA TABELA DE COZEDURA

A tabela indica a função, os acessórios e o nível mais adequados para utilizar na confecção dos diferentes tipos de alimentos.

Os tempos de cozedura começam a partir do momento em que o alimento é colocado no forno, excluindo o pré-aquecimento (sempre que necessário).

As temperaturas e os tempos de cozedura são aproximados e dependem da quantidade de alimento e do tipo de acessório utilizado. Comece por utilizar as definições mais baixas recomendadas e, se o alimento não ficar bem cozinhado, mude para definições mais elevadas. Utilize os acessórios fornecidos e, de preferência, formas para bolos e tabuleiros para assar metálicos e de cor escura. Também poderá utilizar recipientes e acessórios em cerâmica ou pirex, mas tenha em conta que os tempos de cozedura serão ligeiramente superiores.

### COZINHAR DIFERENTES ALIMENTOS EM SIMULTÂNEO

A função "Multilevel" permite-lhe cozinhar, simultaneamente, diferentes alimentos (como peixe e legumes) em diferentes níveis. Retire os alimentos que necessitam de um tempo de cozedura mais curto e deixe no forno os alimentos que necessitam de um tempo de cozedura mais longo.

### FICHA DE PRODUTO

A ficha do produto, incluindo os dados energéticos para este aparelho, pode ser transferida a partir do website **docs.indesit.eu**

### COMO OBTER O GUIA DE UTILIZAÇÃO E MANUTENÇÃO

> Transfira o Guia de Utilização e Manutenção a partir do nosso website **docs.indesit.eu** (pode utilizar este código QR), especificando o código comercial do produto.



> Em alternativa, contacte o nosso Serviço Pós-Venda.

### CONTACTAR O NOSSO SERVIÇO PÓS-VENDA

Pode encontrar os nossos contactos no manual de garantia. Ao contactar o nosso Serviço Pós-Venda, indique os códigos fornecidos na placa de identificação do seu produto.

